

Product Description

Qorvo’s TGA2578-CP is a packaged wideband power amplifier fabricated on Qorvo’s QGaN25 0.25um GaN on SiC process. Operating from 2 to 6 GHz, the TGA2578-CP achieves 30 W saturated output power with a power-added efficiency of > 30 %, and > 26 dB small signal gain.

The TGA2578-CP is offered in a 10-lead 15.2 x 15.2 mm bolt-down package. The package has a pure Cu base, offering superior thermal management. The TGA2578-CP is ideally suited to support both commercial and defense applications.

Both RF ports have integrated DC blocking capacitors and are fully matched to 50 Ohms.

Lead-free and RoHS compliant.

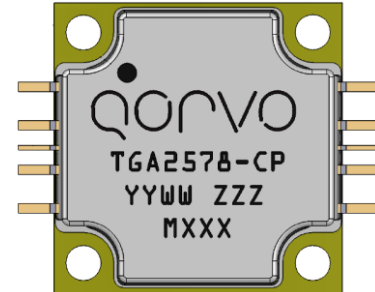

Product Features

- Frequency Range: 2 – 6 GHz
- P_{OUT}: 45 dBm @ P_{IN} = 23 dBm
- PAE: >30% @ P_{IN} = 23 dBm
- Small Signal Gain: > 26 dB
- IM3: -30 dBc @ 30 dBm Pout/Tone
- Bias: V_D = +28 V, I_{DQ} = 400 mA, V_G = -2.8 V typical
- Package Dimensions: 15.2 x 15.2 x 3.5 mm
- Package base is pure Cu offering superior thermal management

Performance is typical across frequency. Please reference electrical specification table and data plots for more details

Functional Block Diagram

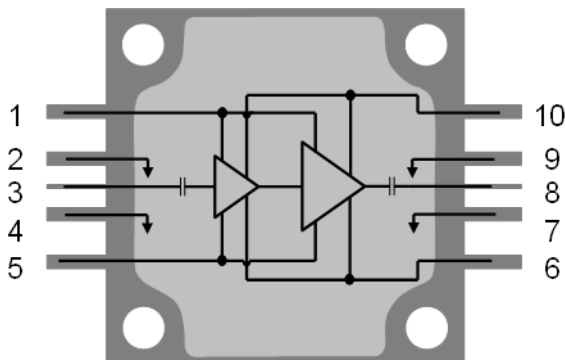

Applications

- Electronic Warfare
- Radar
- Communications
- Test Instrumentation
- EMC Amplifier

Ordering Information

Part No.	Description
TGA2578-CP	2 – 6 GHz 30 W GaN Power Amplifier
1096052	TGA2578-CP Evaluation Board

Absolute Maximum Ratings

Parameter	Value / Range
Drain Voltage (V_D)	40 V
Gate Voltage Range (V_G)	-8 to 0 V
Drain Current (I_D)	5 A
Gate Current (I_G)	See plot page 8
Power Dissipation (P_{DISS}), 85°C	85 W
Input Power (P_{IN}), 50Ω, 85°C, CW	27 dBm
Input Power (P_{IN}), 85°C, VSWR 3:1, $V_D = 28V$, CW	27 dBm
Input Power (P_{IN}), 85°C, VSWR 10:1, $V_D = 28V$, CW	25 dBm
Mounting Temperature	Refer to Assembly Notes, page 11
Storage Temperature	-55 to 150 °C

Operation of this device outside the parameter ranges given above may cause permanent damage. These are stress ratings only, and functional operation of the device at these conditions is not implied.

Recommended Operating Conditions

Parameter	Min	Typ.	Max	Units
Drain Voltage (V_D)		+28		V
Drain Current, (I_{DQ})		400		mA
Gate Voltage (V_G)	-2.8 Typical			V
T_{BASE} Range	-40		+85	°C

Electrical specifications are measured at specified test conditions. Specifications are not guaranteed over all recommended operating conditions.

Electrical Specifications

Parameter	Min	Typ	Max	Units
Operational Frequency Range	2		6	GHz
Small Signal Gain		>26		dB
Input Return Loss		>12		dB
Output Return Loss		>5		dB
Output Power (@ $P_{IN} = 23$ dBm)		45		dBm
Power Added Efficiency (@ $P_{IN} = 23$ dBm)		>30		%
IM3 ($P_{out}/tone = 30$ dBm/Tone)		-30		dBc
IM5 ($P_{out}/tone = 30$ dBm/Tone)		-40		dBc
Small Signal Gain Temperature Coefficient		-0.05		dB/°C
Output Power Temperature Coefficient		-0.02		dBm/°C

Test conditions unless otherwise noted: 25°C, $V_D = +28$ V, $I_{DQ} = 400$ mA, $V_G = -2.8$ V typical, CW.

Typical Performance – Large Signal

Conditions unless otherwise specified: $V_D = 28\text{ V}$, $I_{DQ} = 400\text{ mA}$, $V_G = -2.8\text{ V}$ Typical, CW.

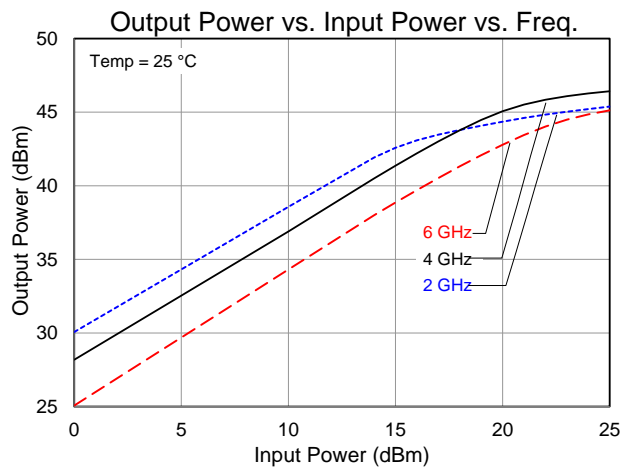
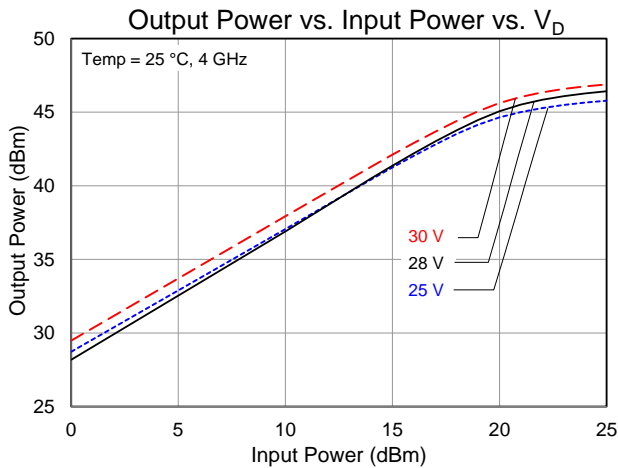
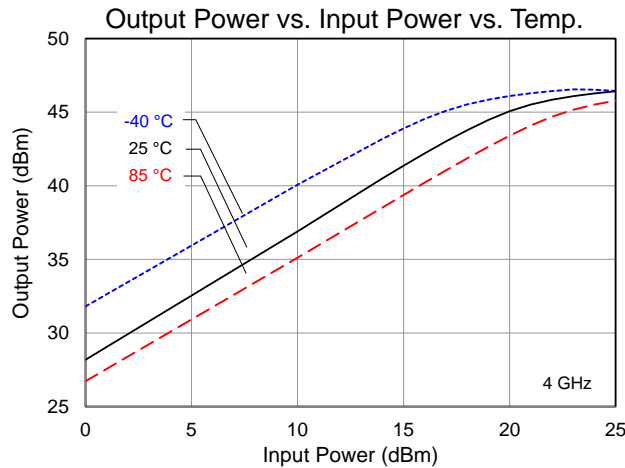
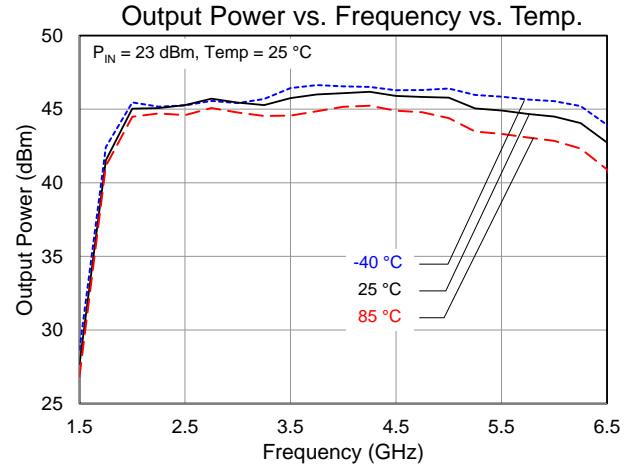
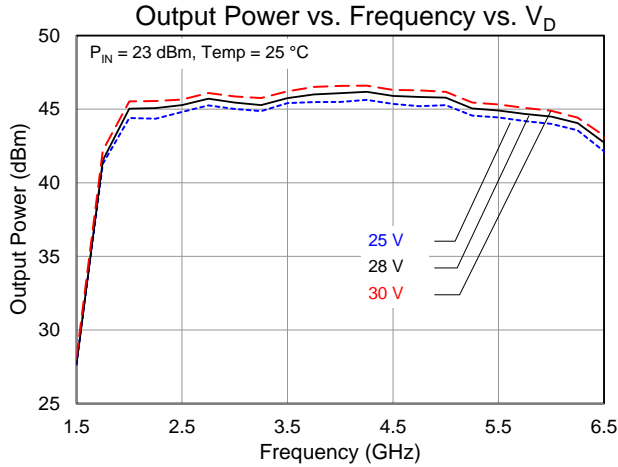

Typical Performance – Large Signal

Conditions unless otherwise specified: $V_D = 28\text{ V}$, $I_{DQ} = 400\text{ mA}$, $V_G = -2.8\text{ V}$ Typical, CW.

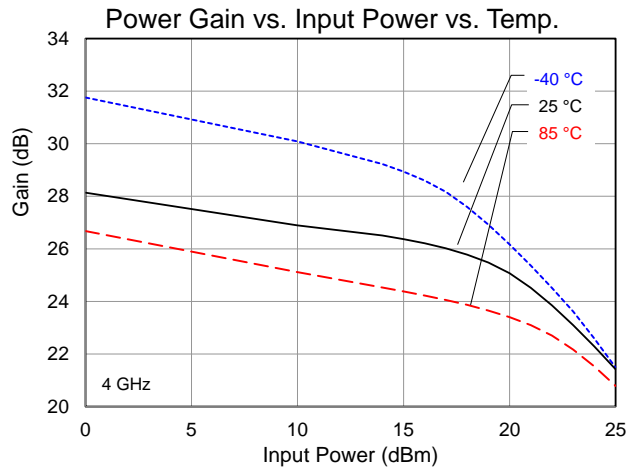
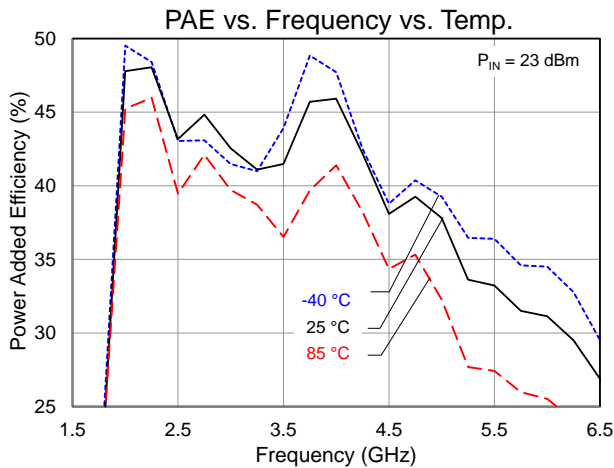
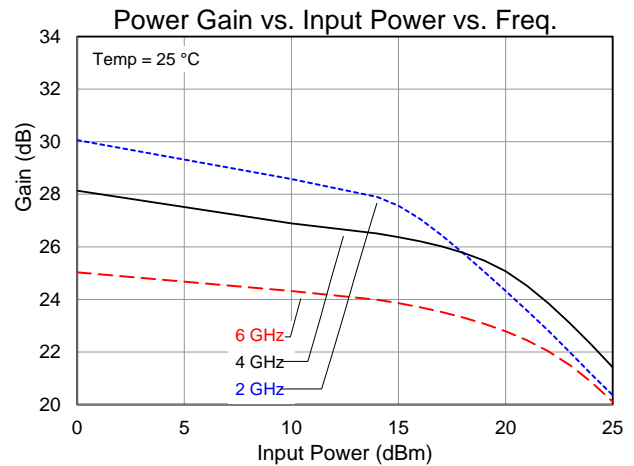
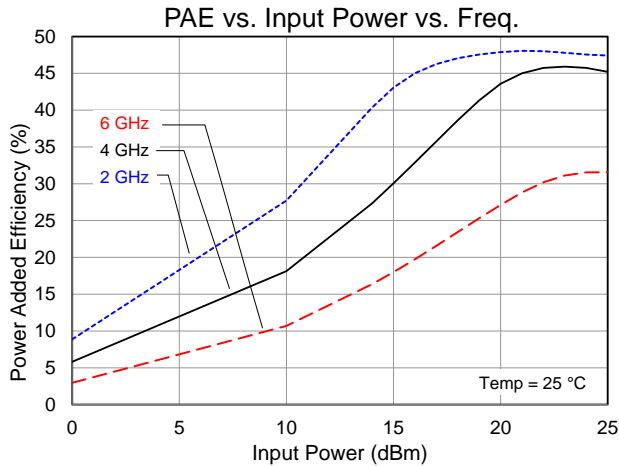
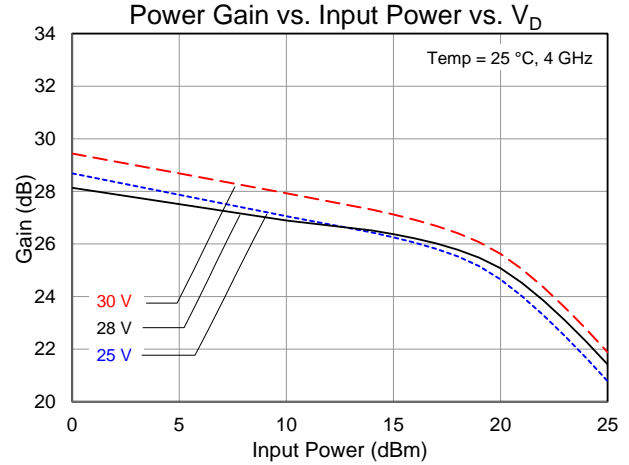
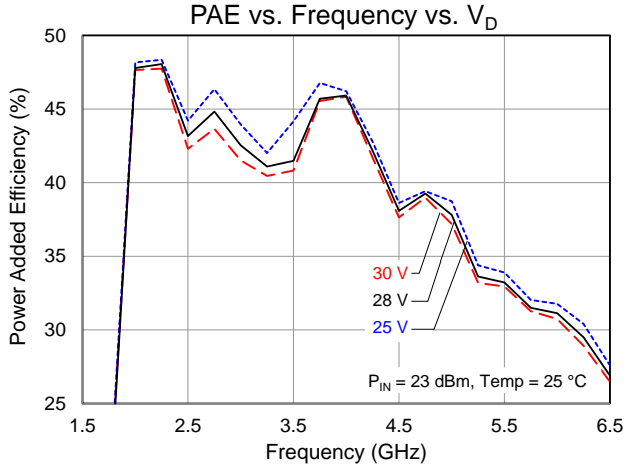

Typical Performance – Large Signal

Conditions unless otherwise specified: $V_D = 28\text{ V}$, $I_{DQ} = 400\text{ mA}$, $V_G = -2.8\text{ V}$ Typical, CW.

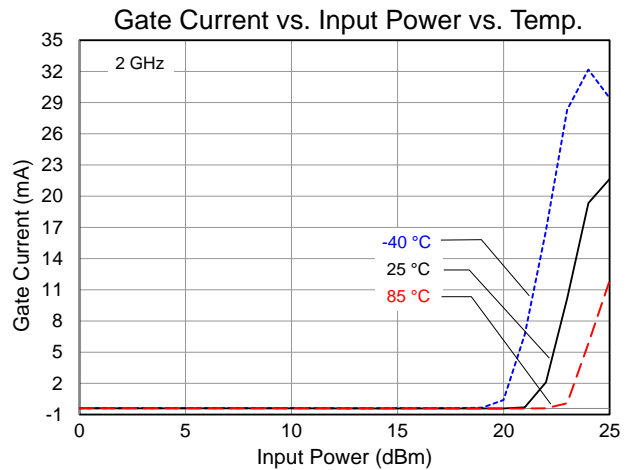
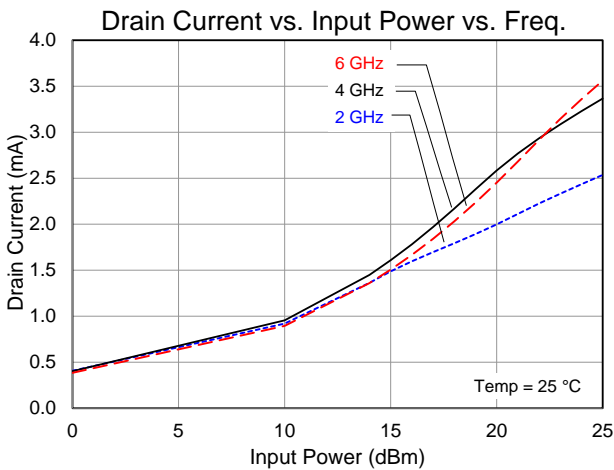
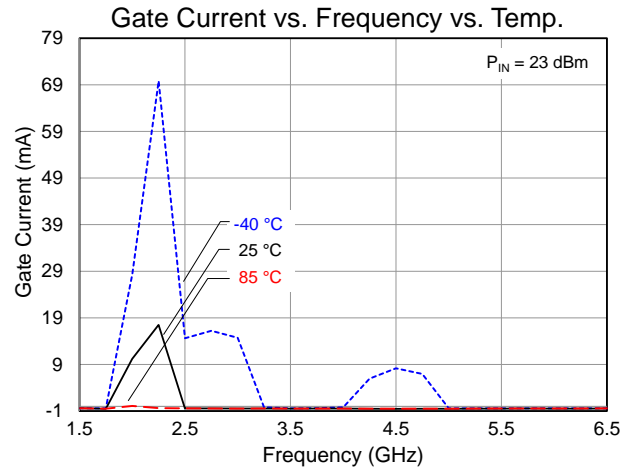
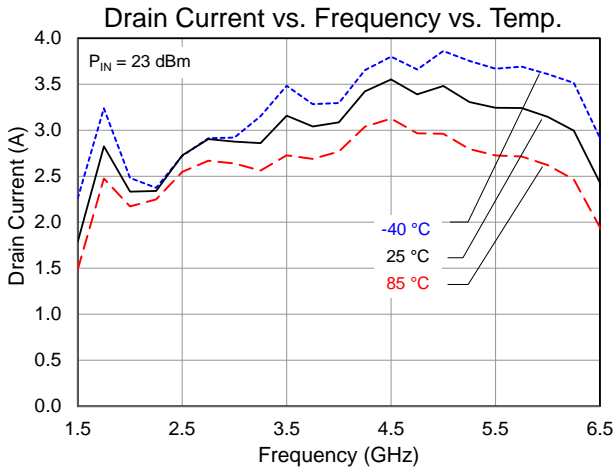
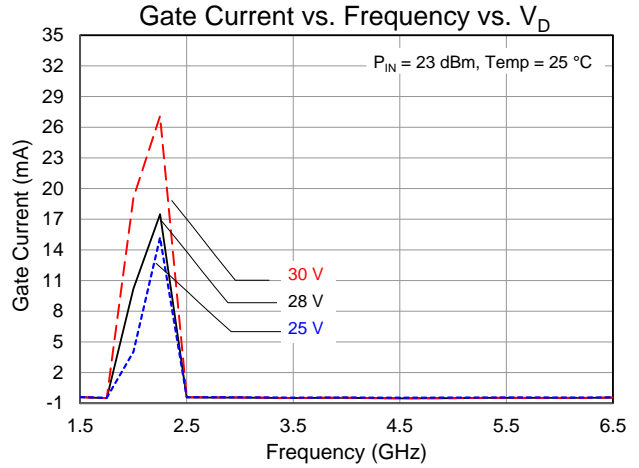
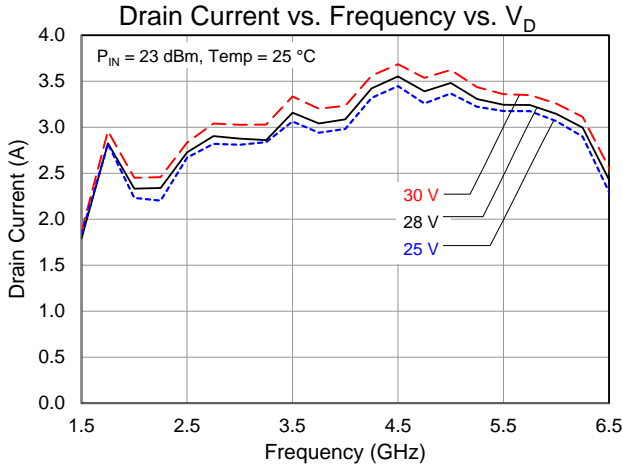

Typical Performance – Linearity

Conditions unless otherwise specified: $V_D = 28\text{ V}$, $I_{DQ} = 400\text{ mA}$, $V_G = -2.8\text{ V}$ Typical, CW.

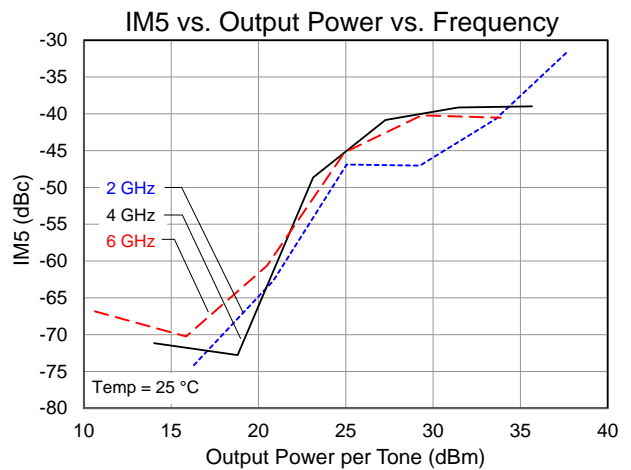
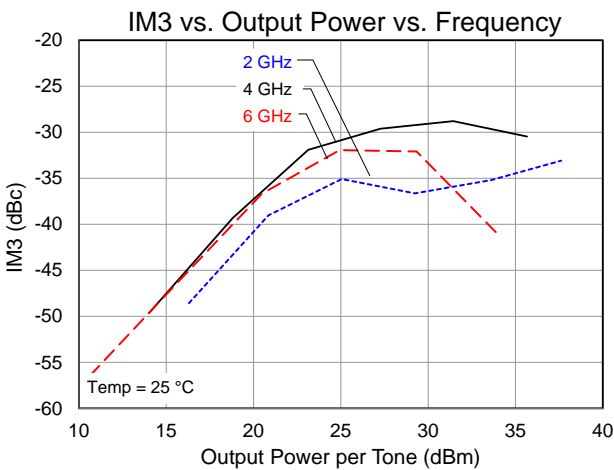
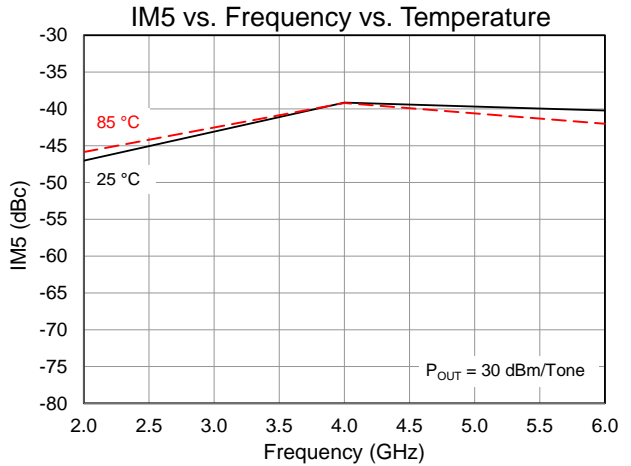
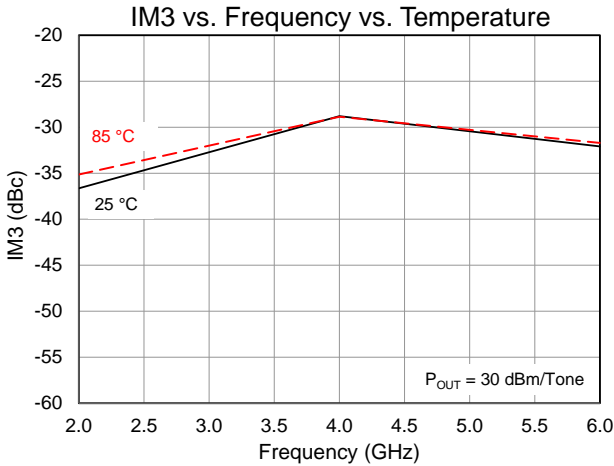
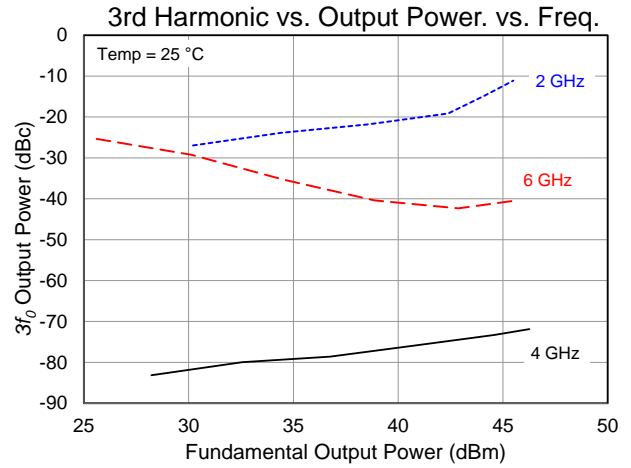
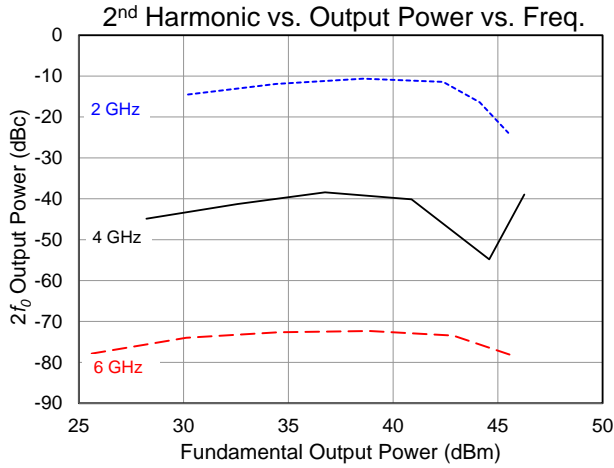

Performance Plots – Small Signal (CW)

Conditions unless otherwise specified: $V_D = 28\text{ V}$, $I_{DQ} = 400\text{ mA}$, $V_G = -2.8\text{ V}$ Typical, CW.

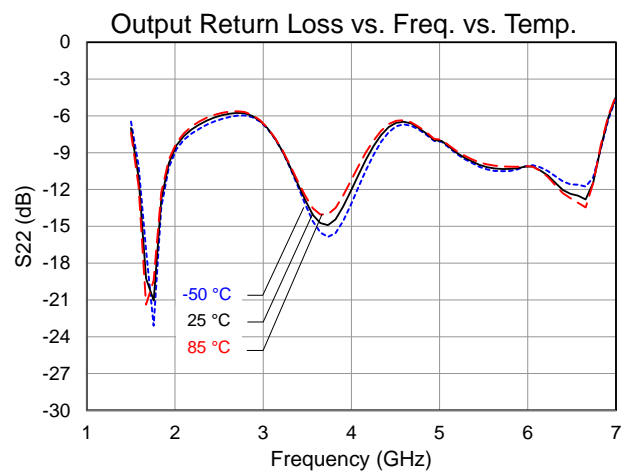
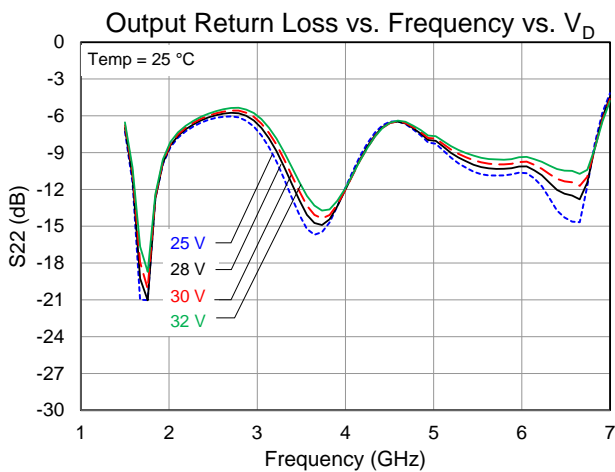
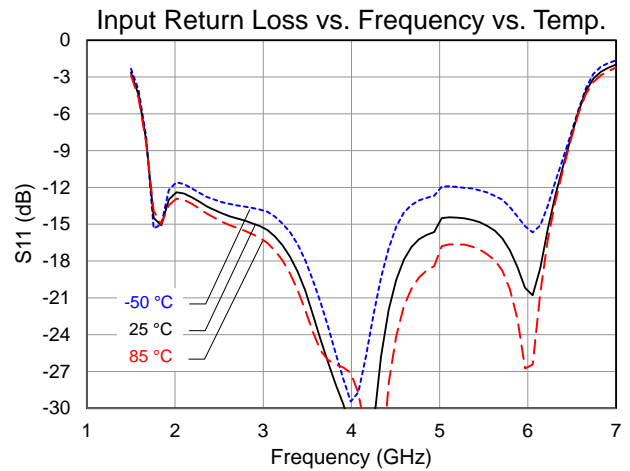
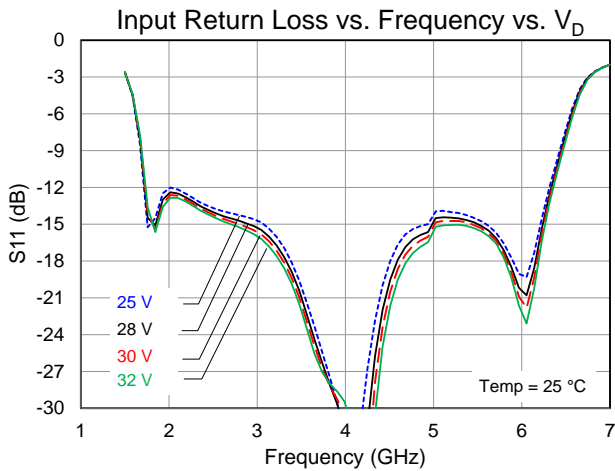
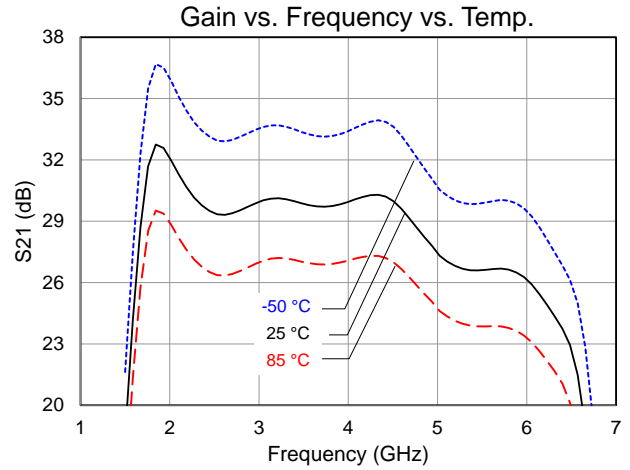
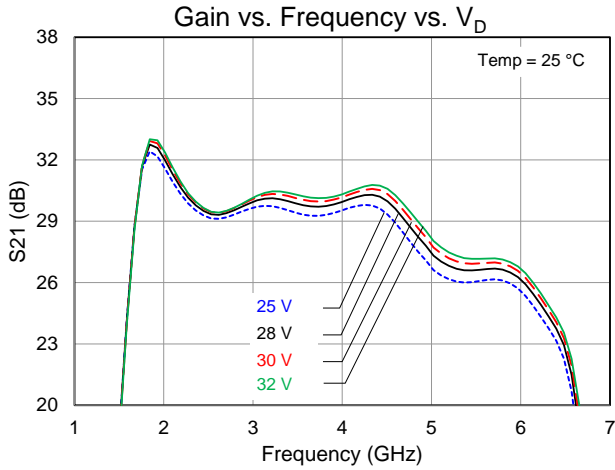

Thermal and Reliability Information

Parameter	Test Conditions	Value	Units
Thermal Resistance (θ_{JC}) ⁽¹⁾	$V_D = 28\text{ V}$, $I_{DQ} = 400\text{ mA}$, Freq. = 5 GHz	1.29	$^{\circ}\text{C/W}$
Channel Temperature, T_{CH} (Under RF) ⁽²⁾	$T_{base} = 85\text{ }^{\circ}\text{C}$, $V_D = 28\text{ V}$, $I_{D_Drive} = 3\text{ A}$, $P_{IN} = 23\text{ dBm}$, $P_{OUT} = 44\text{ dBm}$, $P_{DISS} = 55\text{ W}$	156	$^{\circ}\text{C}$

Notes:

1. Thermal resistance is referenced to the back of package ($85\text{ }^{\circ}\text{C}$)
2. Refer to the following document: [GaN Device Channel Temperature, Thermal Resistance, and Reliability Estimates](#)

Dissipated Power and Maximum Gate Current

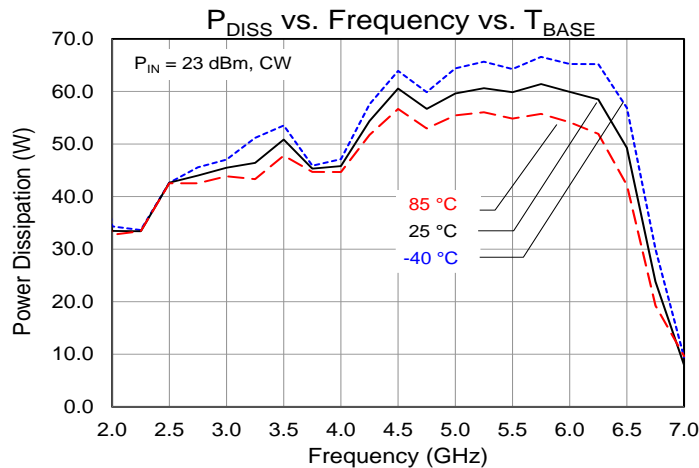
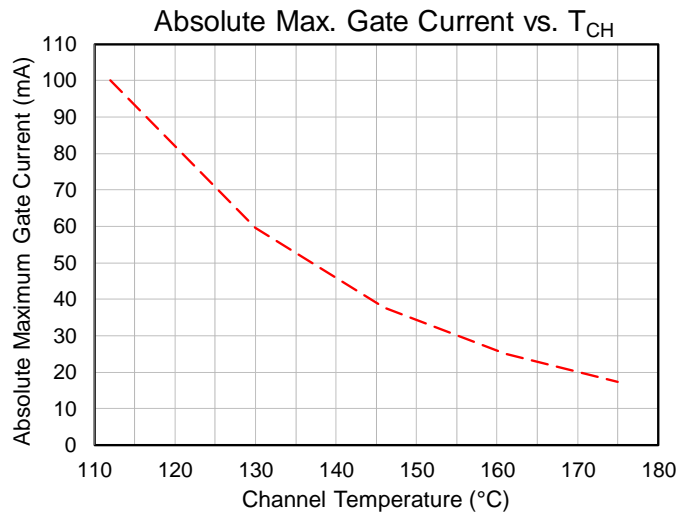

Applications Information and Pin Layout

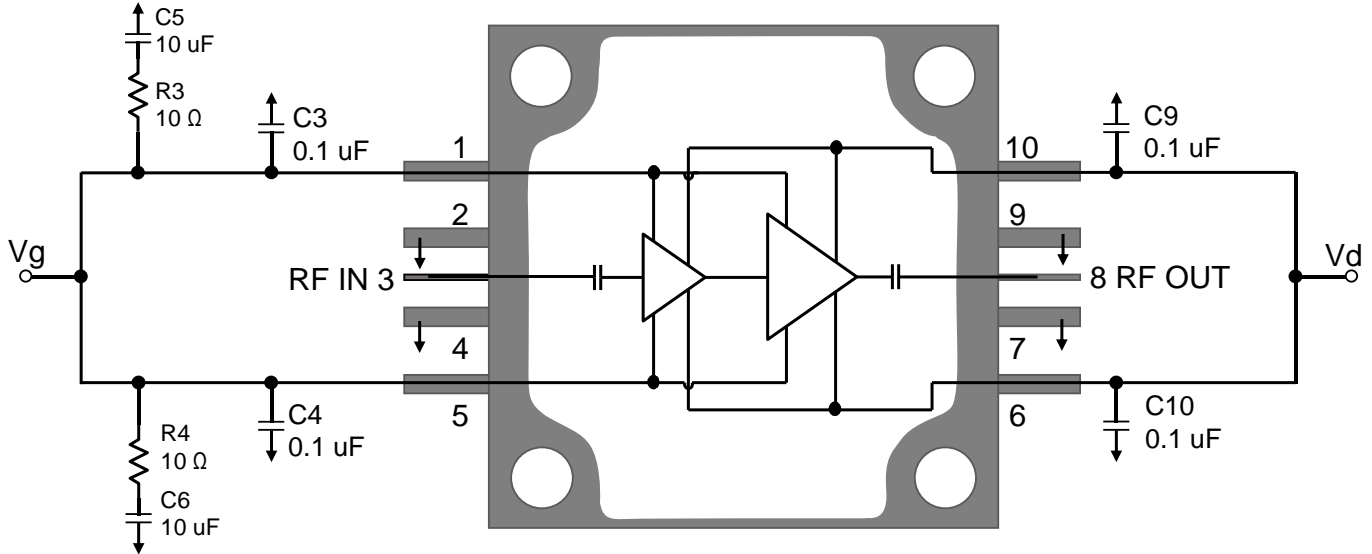

Notes:

1. V_G must be biased from both sides (Pins 1 and 5)
2. V_D must be biased from both sides (Pins 6 and 10)

Bias Up Procedure

1. Set I_D limit to 5 A, I_G limit to 25 mA
2. Apply -5 V to V_G
3. Apply 28 V to V_D ; ensure I_{DQ} is approx. 0 mA
4. Adjust V_G until $I_{DQ} = 400\text{ mA}$ ($V_G \sim -2.8\text{ V Typ.}$).
5. Turn on RF supply

Bias Down Procedure

1. Turn off RF supply
2. Reduce V_G to -5 V ; ensure I_{DQ} is approx. 0 mA
3. Set V_D to 0 V
4. Turn off V_D supply
5. Turn off V_G supply

Pin Description

Pad No.	Symbol	Description
1,5	V_G	Gate Voltage; Bias network is required; must be biased from both sides; see recommended Application Information above.
2,4,7,9	GND	Must be grounded on the PCB.
3	RF_{IN}	Input; matched to $50\ \Omega$; DC blocked
6,10	V_D	Drain voltage; Bias network is required; must be biased from both sides; see recommended Application Information above.
8	RF_{OUT}	Output; matched to $50\ \Omega$; DC blocked.

Evaluation Board (EVB) Assembly Drawing

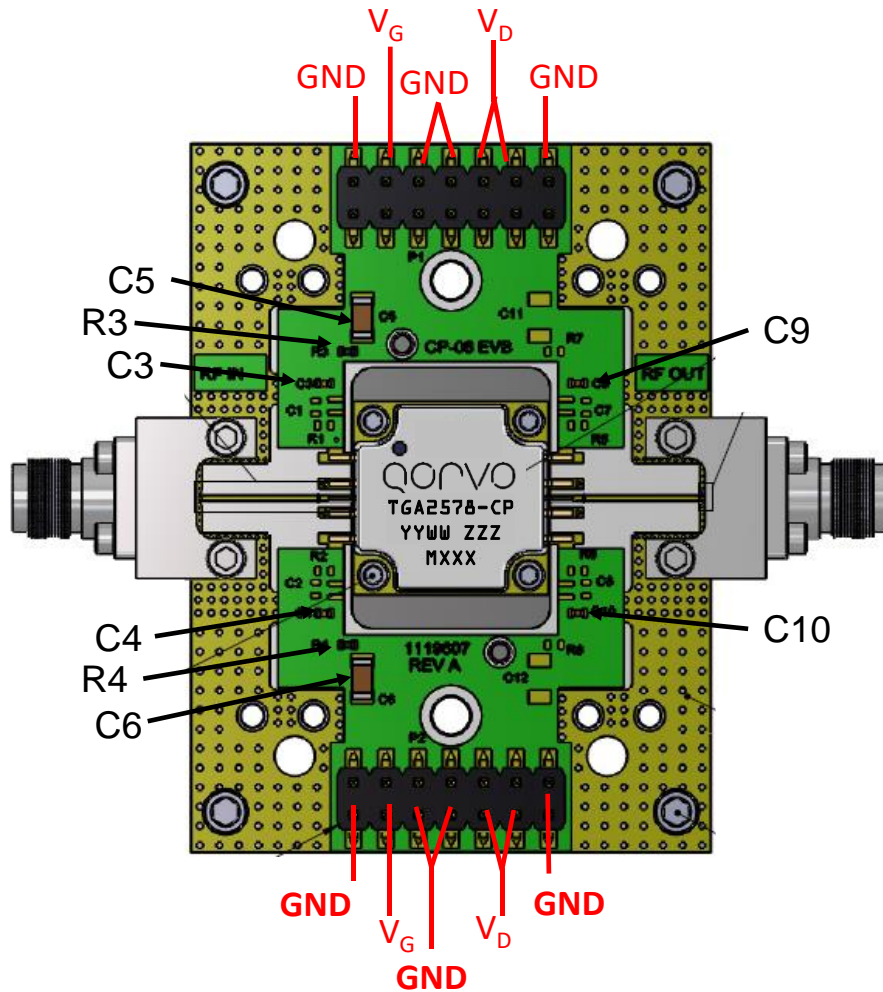

PCB NOTES:

1. PCB is made from Rogers 4003C dielectric, 0.008 inch thick, 0.5 oz. copper both sides.
2. Both Top and Bottom V_D and V_G must be biased.

Bill of Materials

Reference Des.	Value	Description	Manuf.	Part Number
C3, C4, C9, C10	0.1 μ F	Cap, 0402, 50 V, 10%, X7R	Various	–
C5, C6	10 μ F	Cap, 1206, 50 V, 20%, X5R	Various	–
R3, R4	10 Ω	Res, 0402, 5%	Various	–

Assembly Notes

1. Carefully clean the PC board and package leads with alcohol. Allow it to dry fully.
2. To improve the thermal and RF performance, Qorvo recommends attaching a heat sink to the bottom of the PCB and apply thermal compound (Arctic Silver 5 recommended) or 4 mil indium shim between the heat sink and the package.
3. (The following is for *information only*. There are many variables in a second level assembly that Qorvo does not control, so Qorvo does not recommend an absolute torque value.) Use screws to attach the component to the heat sink. A suggested torque value is 16 in-oz. for a 0-80 screw. Start with screws finger tight, then torque to 8 in-oz., then torque to final value. Use the following tightening pattern:

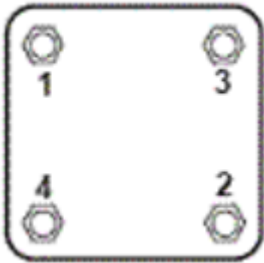

4. The component leads should be manually soldered. Apply a low residue solder alloy meeting J-STD-001 (ROL0, ROL1 or equivalent) with a liquidus temperature below 220 C to each pin of the TGA2578-CP. The use of low residue/no-clean flux (ROL0, ROL1) is recommended. Adding flux during hand soldering of the component leads with localized spot cleaning is acceptable. Soldering irons meeting the requirements of J-STD-001, Appendix A are acceptable. The packaged part should not be subjected to conventional SMT automated solder reflow processes.

Mechanical Information

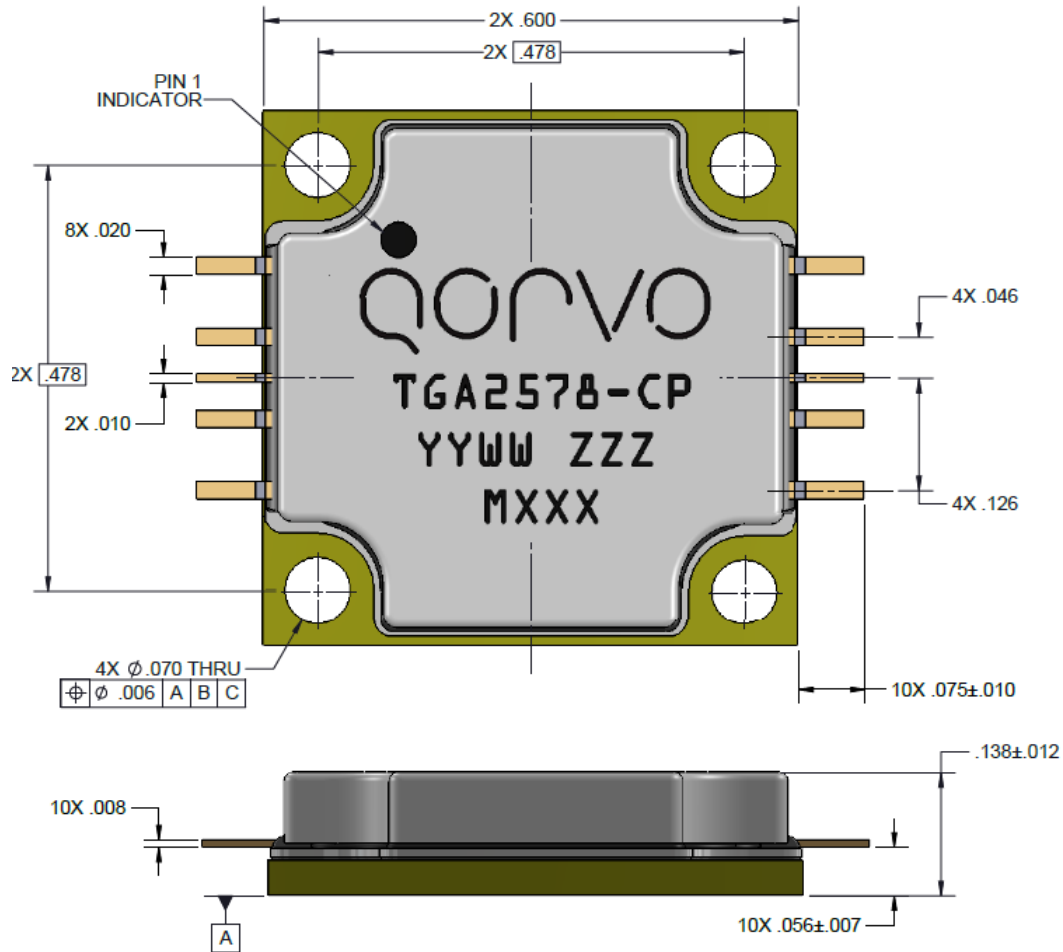

Units: inches

Tolerances: (unless specified)

x.xx = ± 0.01

x.xxx = ± 0.005

Materials:

Base: Copper

Leads: Alloy 194

Lid: Plastic

All metalized features are gold plated

Part is epoxy sealed

Marking:

TGA2578-CP: Part number

YY: Part Assembly year

WW: Part Assembly week

ZZZ: Serial Number (unique for all parts within one assembly lot)

MXXX: Batch ID

Handling Precautions

Parameter	Rating	Standard
ESD – Human Body Model (HBM)	Class 1B	JEDEC Standard JESD22 A114
ESD – Charge Device Model (CDM)	Class C1	JEDEC Standard JESD22-C101F
MSL – Moisture Sensitivity Level	N/A	



Caution!
ESD-Sensitive Device

Solderability

The component leads should be manually soldered, and the package cannot be subjected to conventional reflow processes. The use of no-clean solder to avoid washing after soldering is recommended.

RoHS Compliance

This product is compliant with the 2011/65/EU RoHS directive (Restrictions on the Use of Certain Hazardous Substances in Electrical and Electronic Equipment), as amended by Directive 2015/863/EU. This product also has the following attributes:

- Lead Free
- Halogen Free (Chlorine, Bromine)
- Antimony Free
- TBBP-A (C₁₅H₁₂Br₄O₂) Free
- PFOS Free
- SVHC Free

Contact Information

For the latest specifications, additional product information, worldwide sales and distribution locations:

Web: www.qorvo.com

Tel: 1-844-890-8163

Email: customer.support@qorvo.com

Important Notice

The information contained herein is believed to be reliable; however, Qorvo makes no warranties regarding the information contained herein and assumes no responsibility or liability whatsoever for the use of the information contained herein. All information contained herein is subject to change without notice. Customers should obtain and verify the latest relevant information before placing orders for Qorvo products. The information contained herein or any use of such information does not grant, explicitly or implicitly, to any party any patent rights, licenses, or any other intellectual property rights, whether with regard to such information itself or anything described by such information. **THIS INFORMATION DOES NOT CONSTITUTE A WARRANTY WITH RESPECT TO THE PRODUCTS DESCRIBED HEREIN, AND QORVO HEREBY DISCLAIMS ANY AND ALL WARRANTIES WITH RESPECT TO SUCH PRODUCTS WHETHER EXPRESS OR IMPLIED BY LAW, COURSE OF DEALING, COURSE OF PERFORMANCE, USAGE OF TRADE OR OTHERWISE, INCLUDING THE IMPLIED WARRANTIES OF MERCHANTABILITY AND FITNESS FOR A PARTICULAR PURPOSE.**

Without limiting the generality of the foregoing, Qorvo products are not warranted or authorized for use as critical components in medical, life-saving, or life-sustaining applications, or other applications where a failure would reasonably be expected to cause severe personal injury or death.

Copyright 2022 © Qorvo, Inc. | Qorvo is a registered trademark of Qorvo, Inc.

Mouser Electronics

Authorized Distributor

Click to View Pricing, Inventory, Delivery & Lifecycle Information:

[Qorvo:](#)

[TGA2578-CP](#)