

**Recommended PCB Layout**

(Viewed from Component Side - Tolerance:±0.05mm)

Solder Area 
 Keep Out Area 
 Component Outline

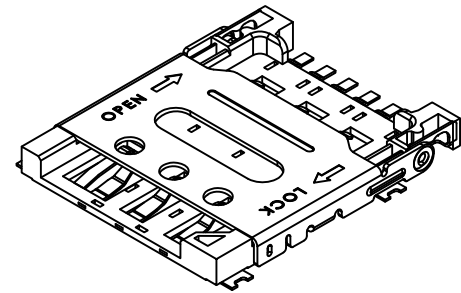

**Specifications**

**Material**

Plastic Housing: High Temperature Thermoplastic  
 UL94V-0, Black  
 Contact Terminal: Copper Alloy  
 Metallic Shell: SUS

**Plating**

Contact :1μ" Gold over 50μ" Nickel  
 Shell: 30μ" Nickel over all

**Electrical**

Voltage rating: 125V AC/DC  
 Current Rating: 0.5 Amp AC/DC Max.  
 Contact Resistance: 80 mΩ Max.  
 Dielectric Withstanding Voltage:500V AC (60 Sec Min. )  
 Insulation Resistance: 100 MΩ Min.@100V DC

**Mechanical & Environmental**

Operating Temperature: -20°C to +85°C  
 Durability : 5,000 cycles

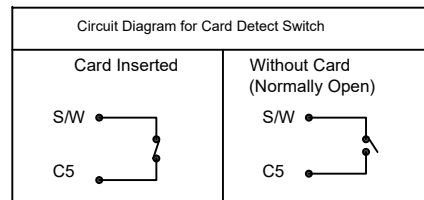
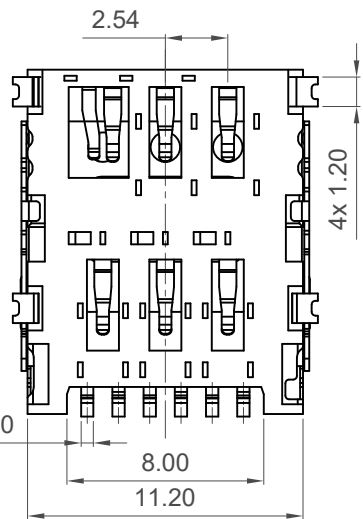

**Ordering Grid**

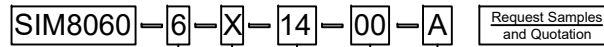

**No. of Contacts**  
 6  
**Switch**  
 0 = Without  
 (Contact SW removed from component)  
 1 = With  
**Profile Height**  
 14 = 1.43mm

**Packing Options**  
 A = Tape & Reel  
 (1500pcs per reel)  
**Locating Peg**  
 00 = Without

Part Number		Product Description	
SIM8060		Nano SIM Card Connector	
Drawing Date		Hinged Type,SMT,6Pin, 1.43mm Profile	
6th September 2018			
By	CC	Tolerances (Except as Noted)	Units:
Detail	Drawing Release	Length	Metric (mm)
Revision	A2	X.X ± 0.15	
Date	15/10/21	X.XX ± 0.10	
		X.XXX ± 0.05	± 1°
		This drawing is confidential and copyright of Global Connector Technology, Ltd (GCT). This drawing must not be copied or disclosed without written consent. E & OE	



www.gct.co

Not to Scale	Drawn By CC	Sheet No. 1/4
--------------	-------------	---------------

1 Slide metal lid from 'LOCK' position to 'OPEN' position

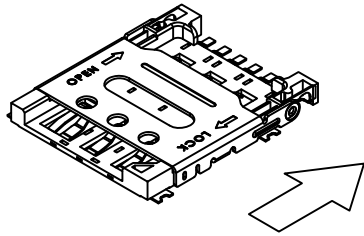

2 Open metal lid to allow Nano SIM card to be inserted

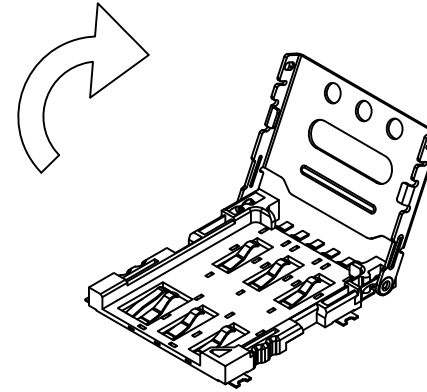



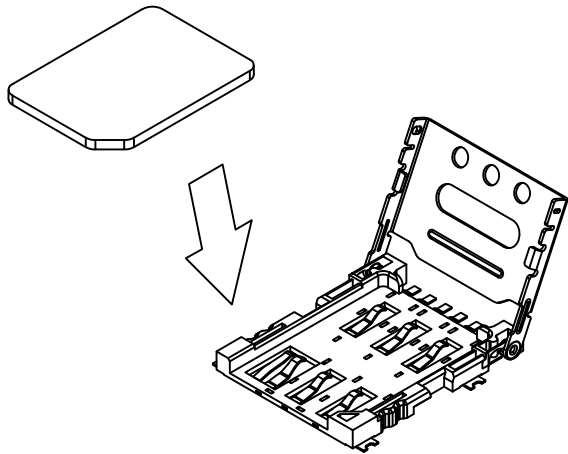

3 Place Nano SIM card against contacts, chip face down

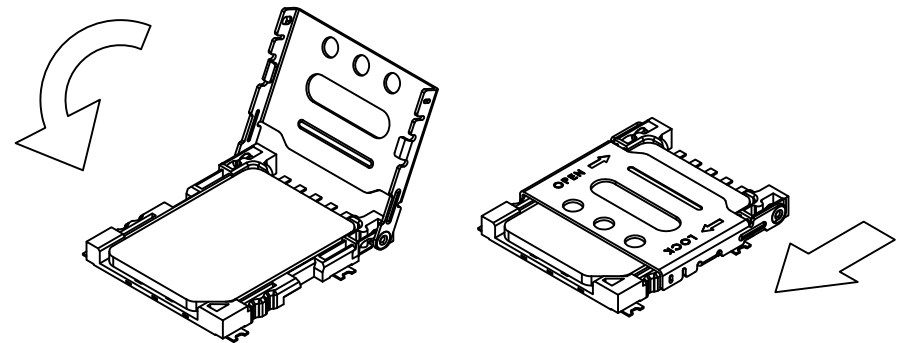

4 Close metal lid and slide back to 'LOCK' position



Part Number		Product Description		 www.gct.co
SIM8060		Nano SIM Card Connector		
Drawing Date		Hinged Type, SMT, 6Pin, 1.43mm Profile		
6th September 2018				
By	CC	Tolerances (Except as Noted)		Units:
Detail	Drawing Release	Length	Angle	Metric (mm)
Revision	A2	X.X ± 0.15		 RoHS COMPLIANT 2011/65/EU
Date	15/10/21	X.XX ± 0.10	± 1°	 This drawing is confidential and copyright of Global Connector Technology, Ltd (GCT). This drawing must not be copied or disclosed without written consent. E & OE
		X.XXX ± 0.05		 3rd Angle Projection
Not to Scale		Drawn By	CC	Sheet No.
				2/4

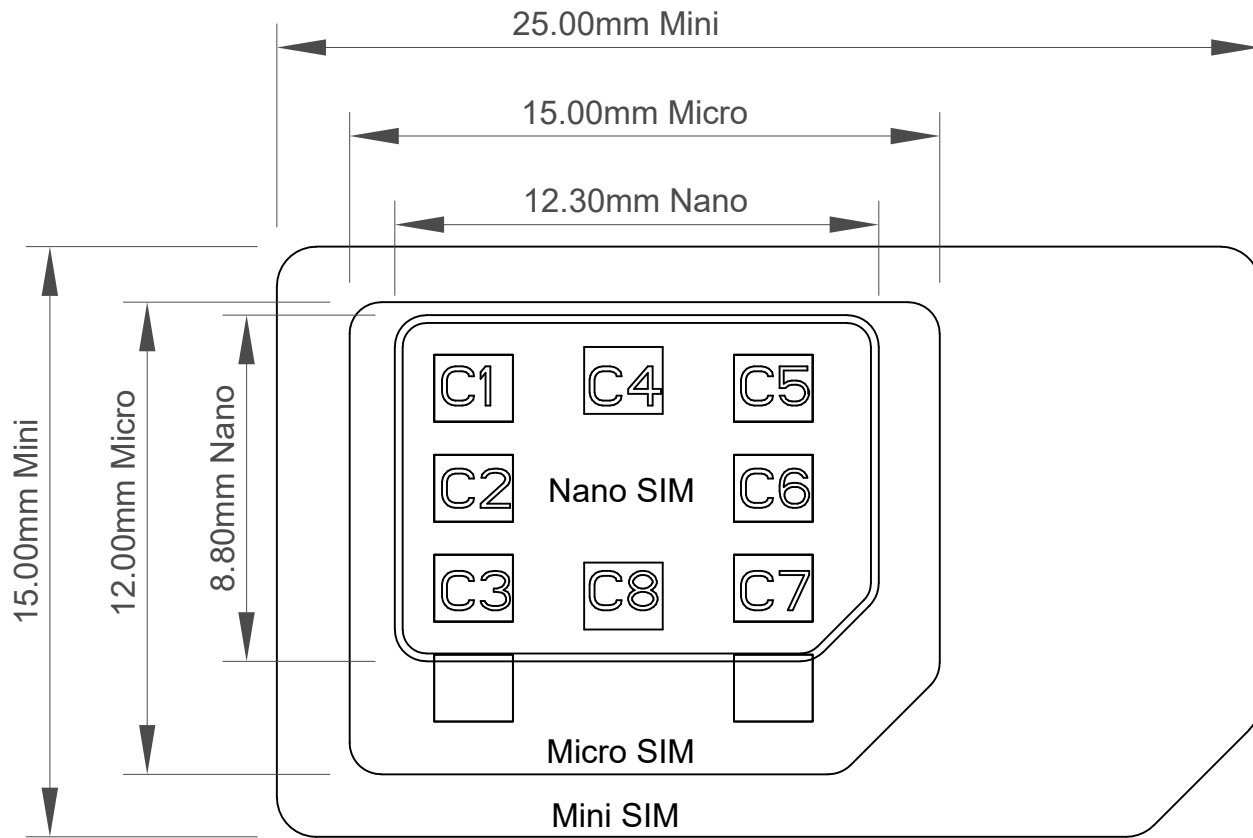

- C1----->VCC
- C2----->RST
- C3----->CLK
- C5----->GND
- C6----->Vpp
- C7----->I/O

### Reference

Part Number		Product Description	
SIM8060		Nano SIM Card Connector	
Drawing Date		Hinged Type,SMT,6Pin, 1.43mm Profile	
6th September 2018			
By	CC	Tolerances (Except as Noted)	
Detail	Drawing Release	Length	Angle
Revision	A2	X.X ± 0.15	± 1°
Date	15/10/21	X.XX ± 0.10	
		X.XXX ± 0.05	
		Units:	
		Metric (mm)	
		This drawing is confidential and copyright of Global Connector Technology, Ltd (GCT). This drawing must not be copied or disclosed without written consent. E & OE	

**GCT**  
www.gct.co

Not to Scale	Drawn By CC	Sheet No. 3/4
--------------	----------------	------------------

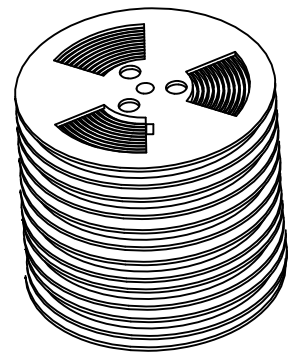
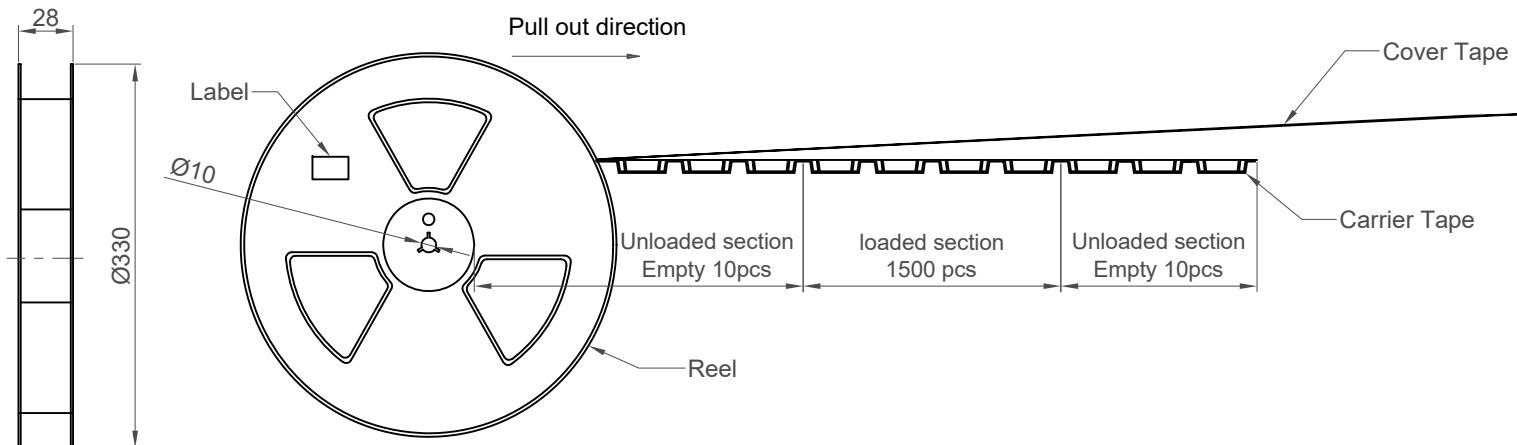

1500pcsX10=15000pcs

Pcs/Reel	Reels/Carton	Pcs/Carton	Carton Dimensions
1500	10	15000	345 x 345 x 315mm

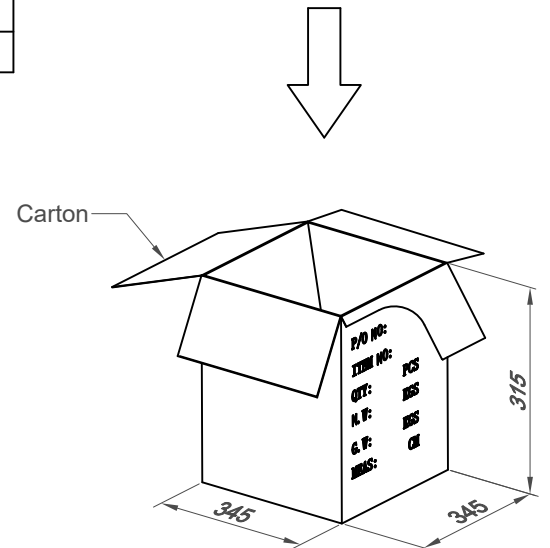
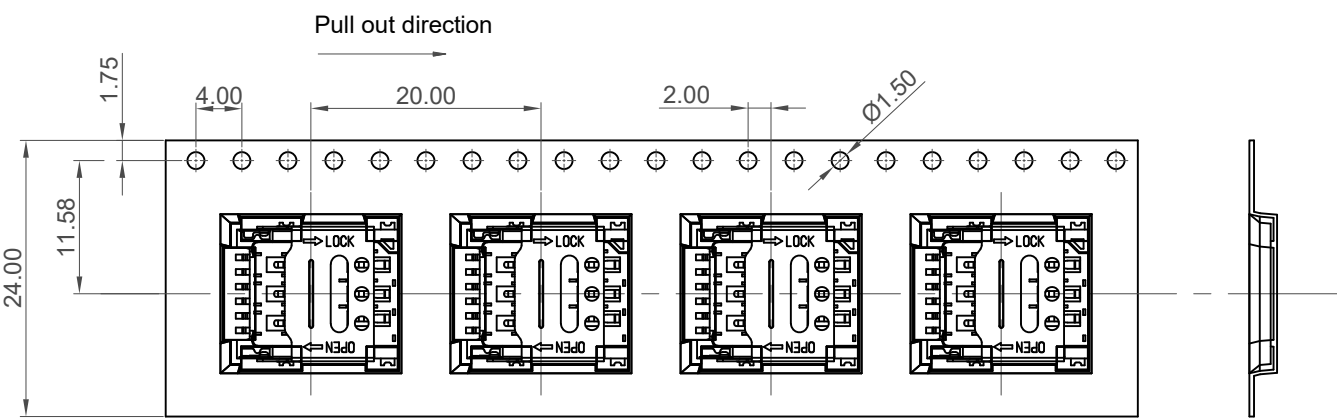

Part Number SIM8060		Product Description Nano SIM Card Connector Hinged Type,SMT,6Pin, 1.43mm Profile	
Drawing Date 6th September 2018			
By CC	Detail Drawing Release	Tolerances (Except as Noted) Length X.X ± 0.15 X.XX ± 0.10 X.XXX ± 0.05	Units: Metric (mm) ± 1°
Revision A2	Date 15/10/21		
<small>This drawing is confidential and copyright of Global Connector Technology, Ltd (GCT). This drawing must not be copied or disclosed without written consent. E &amp; OE</small>			

**GCT**  
www.gct.co

Not to Scale	Drawn By CC	Sheet No. 4/4
--------------	----------------	------------------

# Mouser Electronics

Authorized Distributor

Click to View Pricing, Inventory, Delivery & Lifecycle Information:

[Global Connector Technology \(GCT\):](#)

[SIM8060-6-0-14-00-A](#)