

ZL70550 Datasheet
Ultra-Low-Power Sub-GHz RF Transceiver





Microsemi Corporate Headquarters

One Enterprise, Aliso Viejo,
CA 92656 USA

Within the USA: +1 (800) 713-4113

Outside the USA: +1 (949) 380-6100

Sales: +1 (949) 380-6136

Fax: +1 (949) 215-4996

E-mail: sales.support@microsemi.com

www.microsemi.com

© 2015–2016 Microsemi Corporation.
All rights reserved. Microsemi and the
Microsemi logo are trademarks of
Microsemi Corporation. All other
trademarks and service marks are the
property of their respective owners.

Microsemi makes no warranty, representation, or guarantee regarding the information contained herein or the suitability of its products and services for any particular purpose, nor does Microsemi assume any liability whatsoever arising out of the application or use of any product or circuit. The products sold hereunder and any other products sold by Microsemi have been subject to limited testing and should not be used in conjunction with mission-critical equipment or applications. Any performance specifications are believed to be reliable but are not verified, and Buyer must conduct and complete all performance and other testing of the products, alone and together with, or installed in, any end-products. Buyer shall not rely on any data and performance specifications or parameters provided by Microsemi. It is the Buyer's responsibility to independently determine suitability of any products and to test and verify the same. The information provided by Microsemi hereunder is provided "as is, where is" and with all faults, and the entire risk associated with such information is entirely with the Buyer. Microsemi does not grant, explicitly or implicitly, to any party any patent rights, licenses, or any other IP rights, whether with regard to such information itself or anything described by such information. Information provided in this document is proprietary to Microsemi, and Microsemi reserves the right to make any changes to the information in this document or to any products and services at any time without notice.

About Microsemi

Microsemi Corporation (Nasdaq: MSCC) offers a comprehensive portfolio of semiconductor and system solutions for aerospace & defense, communications, data center and industrial markets. Products include high-performance and radiation-hardened analog mixed-signal integrated circuits, FPGAs, SoCs and ASICs; power management products; timing and synchronization devices and precise time solutions, setting the world's standard for time; voice processing devices; RF solutions; discrete components; enterprise storage and communication solutions, security technologies and scalable anti-tamper products; Ethernet solutions; Power-over-Ethernet ICs and midspans; as well as custom design capabilities and services. Microsemi is headquartered in Aliso Viejo, Calif., and has approximately 4,800 employees globally. Learn more at www.microsemi.com.

Contents

1	Revision History	1
1.1	Revision 4	1
1.2	Initial Release	1
1.3	Preliminary and Advanced Information	1
2	Overview	2
2.1	Introduction	2
2.2	Features and Specifications	2
2.2.1	Block Diagram	3
2.3	Target Applications	3
2.3.1	Typical Application Diagram	4
3	Functional Descriptions	5
3.1	MAC Packet Modes	5
3.1.1	Raw Bit Packet Mode	6
3.1.2	Raw Packet Mode	6
3.1.3	User Packet Mode	7
3.1.4	Z-Star Packet Mode	8
4	Electrical Specifications	9
4.1	Absolute Maximum Ratings	9
4.1.1	Recommended Operating Conditions	9
4.2	Electrical Characteristics	10
4.2.1	Voltage Regulators	10
4.2.2	Digital Interface	10
4.2.3	Performance Characteristics	11
4.3	Transmit Power Characteristics	15
4.3.1	Transmit Power vs. PA Trim Value	15
4.3.2	Transmit Power vs. Current Consumption	15
5	Pin Descriptions	16
5.1	Pin Diagrams	16
5.2	Pin Lists	17
5.3	Functional Pin Descriptions	18
6	Package Information	20
6.1	Drawing and Markings for 32-Pin QFN Package	20
6.2	Drawing and Markings for 29-Pin CSP Package	21
7	Ordering Information	23

Figures

Figure 1	ZL70550 RF Transceiver Block Diagram	3
Figure 2	50-Ω Single-Ended Application Example with Optional Low-Pass Filter	4
Figure 3	Packet Format, Raw Packet Mode	6
Figure 4	Packet Format, User Packet Mode	7
Figure 5	Packet Format, Z-Star Packet Mode	8
Figure 6	Crystal Oscillator Circuit	14
Figure 7	TX Power vs. PA Trim Value	15
Figure 8	TX Power vs. Current Consumption	15
Figure 9	Footprint (top view) for 32-Pin QFN	16
Figure 10	Footprint (bottom view) for 29-Pin CSP Package	16
Figure 11	Package Drawing and Package Dimensions for 32-Pin QFN	20
Figure 12	Markings for 32-Pin QFN	21
Figure 13	Package Drawing and Package Dimensions for 29-Pin CSP	21
Figure 14	Markings for 29-Pin CSP	22

Tables

Table 1	Packet Modes of Operation	5
Table 2	Absolute Maximum Ratings	9
Table 3	Recommended Operating Conditions	9
Table 4	Voltage Regulators	10
Table 5	Digital I/O AC and DC Specifications	10
Table 6	General Characteristics	11
Table 7	Current Consumption	11
Table 8	Synthesizer	12
Table 9	Transmitter RF Characteristics	12
Table 10	Receiver RF Characteristics	13
Table 11	Crystal Specifications	14
Table 12	Pinout for 32-Pin QFN	17
Table 13	Overview of ZL70550 Interconnects	18
Table 14	Pinout for 29-Pin CSP	18
Table 15	Pin Coordinates for PCB Layout for 29-Pin CSP (top-down view)	22
Table 16	Ordering and Package Overview	23

1 Revision History

The revision history describes the changes that were implemented in the document since initial release. The changes are listed by revision, starting with the most current publication.

1.1 Revision 4

The following is a summary of the substantive changes in revision 4 of this document, dated July 2016.

- Item 1. Added footnote 1 to [Table 2](#), page 9.
- Item 2. Modified turnaround time in [Table 9](#), page 12.

1.2 Initial Release

Revision 3 of this document, dated June 2016, was the initial release of the production version of the datasheet.

1.3 Preliminary and Advanced Information

Revision 2 of this document, dated February 2016, was a preliminary datasheet. Such preliminary datasheets may be based on simulation or initial characterization and are subject to change.

Revision 1, dated September 2015, was the first publication of this document. This Advanced Datasheet version contained initial estimated information based on simulation, other products, devices, or speed grades. Such advanced information can be used as estimates, but not for production, as the data is not fully characterized.

2 Overview

2.1 Introduction

The ZL70550 ultra-low-power RF transceiver provides efficient wireless communications for applications where power consumption is of primary importance. With combined ultralow transmit, receive, and sleep currents, the ZL70550 device is best-in-class for a wide range of high- and low-duty-cycle applications. The transceiver's small size and ultralow power requirements make it feasible to operate the device with a single coin-cell battery or with energy-harvesting sources in extremely small form factors. The built-in support for Microsemi's highly efficient and powerful Z-Star protocol allows users to rapidly develop ultra-low-power wireless applications.

2.2 Features and Specifications

The ZL70550 RF transceiver features include:

- Ultralow power
 - Typical TX current (with 50- Ω match):
 - < 2.75 mA at -10 dBm;
 - < 5.3 mA at 0 dBm
 - Typical RX current: < 2.4 mA (low I_{RX} mode)
 - Sleep current: < 10 nA typical
 - Supply: 1.71 V to 3.6 V
- Operating frequency range: 779 MHz to 965 MHz
 - North American ISM band: 902 MHz to 928 MHz
 - European SRD band: 863 MHz to 870 MHz
 - Chinese band: 779 MHz to 787 MHz
 - Japanese bands: 916 MHz to 930 MHz and 950 MHz to 956 MHz
- Sensitivity and data rate:
 - Raw data rate: 200 kbit/s, 100 kbit/s, or 50 kbit/s
 - Typical sensitivity:
 - 106 dBm typical at 50 kbit/s at 3.2 mA and with FEC
 - 103 dBm typical at 50 kbit/s at 2.4 mA and with FEC
 - 99 dBm typical at 200 kbit/s at 3.2 mA and without FEC
 - 95 dBm typical at 200 kbit/s at 2.4 mA and without FEC
- Very few external components
 - Matching network, crystal, decoupling capacitors, and bias resistor
 - Standard interface: SPI bus
- Optional built-in MAC
 - Microsemi Z-Star or user protocol support
 - Transmit and receive buffer
 - Automatic CSMA packet transfers
 - Efficient header optimized for small or large payloads
 - Optional preamble, frame sync, length, FEC, and CRC
- RoHS compliant

2.2.1 Block Diagram

Figure 1 • ZL70550 RF Transceiver Block Diagram

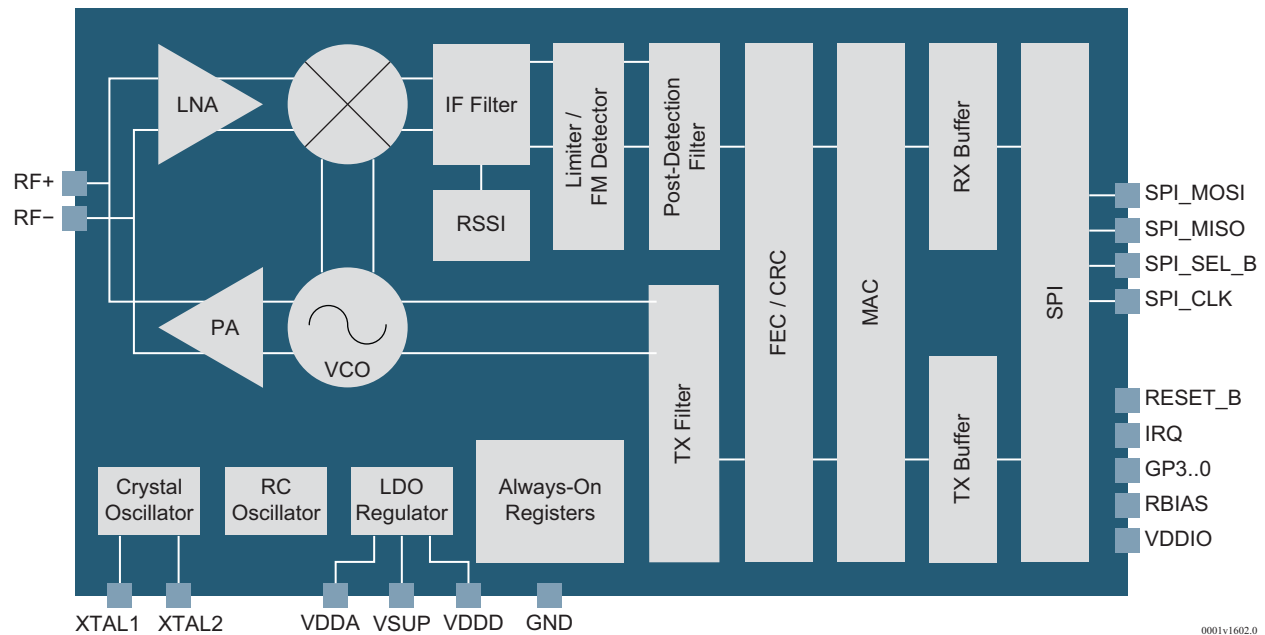

2.3 Target Applications

End applications may include:

- Medical monitoring
- Industrial/building/home automation
- Security
- Smart cities
- Advanced metering infrastructure
- Asset management
- Energy harvesting
- Voice/compressed-audio communications

2.3.1 Typical Application Diagram

The following figure is representative of a 50-Ω single-ended implementation (refer to Figure 2, page 4). An optional low-pass filter on the output is recommended to attenuate second and third harmonic spurious emissions to meet regulatory standards.

Figure 2 • 50-Ω Single-Ended Application Example with Optional Low-Pass Filter

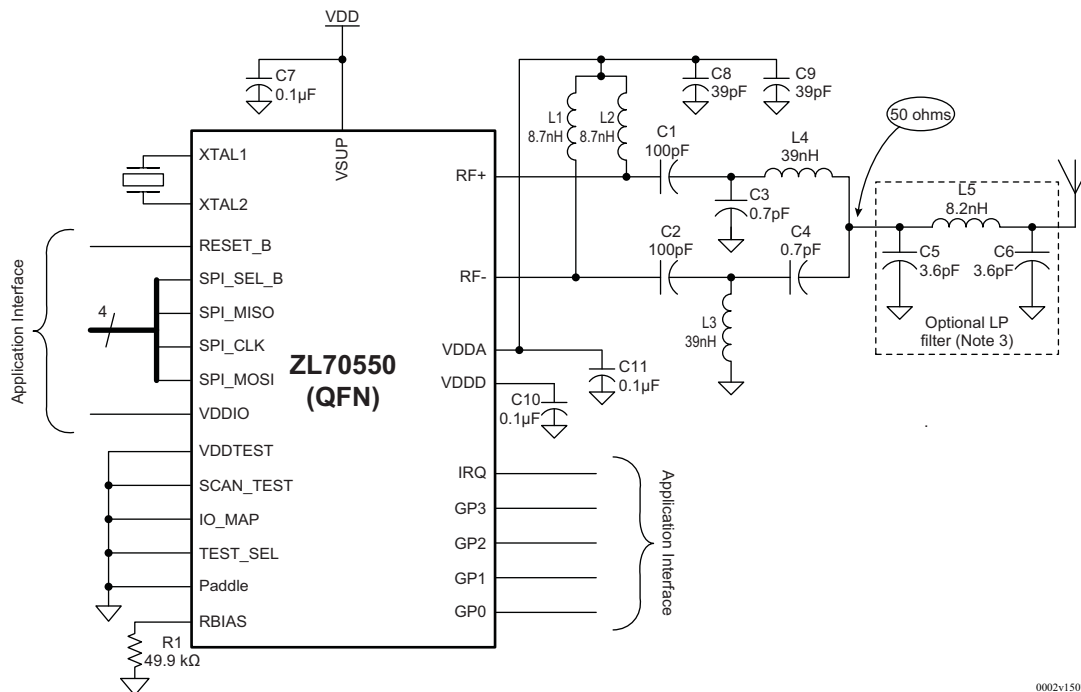

0002v1507.1

Notes:

1. This schematic is based on the REMOTE550 board from the ZLE70550 Application Development Kit.
2. C3, C4, L3, and L4 values may change if the layout differs from the REMOTE550 board layout. To ensure optimal performance, please do not deviate from the REMOTE550 board layout.
3. L1 and L2 are optimized for tuning over the middle to upper frequency range (863MHz to 965MHz). Changing L1 and L2 to approximately 12nH allows tuning over the lower to middle frequency range (779MHz to 868MHz).
4. The optional low-pass filter reduces the transmitter spurious emissions by approximately 16dB for the second harmonic and 23dB for the third harmonic. Another option would be to replace this circuit with a SAW filter to attenuate spurious emissions and to provide protection against blockers.
5. Use Murata part number GCM155R71C104KA55D or equivalent for C10 and C11.

3 Functional Descriptions

The ultra-low-power ZL70550 RF transceiver enables RF telemetry in applications powered by coin-cell batteries or energy harvesting, where wireless telemetry was previously unfeasible. End applications may include wireless sensors, medical monitoring, industrial/home automation, or smart cities.

With a typical peak/average current consumption below 2.4mA in receive and 2.75mA in transmit, and with an upper data rate of 200kbit/s, the ZL70550 device enables bidirectional RF links over a distance of more than 100 meters (based on antenna gain and matching loss).

The output power is programmable and can be reduced to -25dBm to save power in cases where the link budget allows it, or can be increased up to 0dBm for more range or to allow for system losses such as a very small antenna or body tissue absorption.

To achieve the minimum possible power consumption, the ZL70550 device offers many automatic calibrations, all available to the user via the SPI bus.

In addition to its ultralow power consumption, the ZL70550 device also includes a highly flexible Media Access Controller (MAC) that offers four different packet modes of operation ranging from automatic packet transactions to low-level direct modulation via a serial clock and data.

3.1 MAC Packet Modes

The three different packet modes in which the ZL70550 MAC state machine operates, as well as a direct modulation mode where users have full control over their own packet or streaming protocols, are described in [Table 1](#), page 5. These packet modes give users tremendous flexibility in defining their own packet parameters and transaction capabilities, ranging from a user-defined bit stream to fully automated multipacket transactions based on Microsemi's Z-Star protocol.

Table 1 • Packet Modes of Operation

Packet Mode	Description	Pre/Frm Sync	FEC	PHY Header	Auto-Length	MAC Header	CRC
Raw bit	Optional serial clock and data (TX/RX buffer or GP3..0 pins)	No	No	No	No	No	No
Raw	Compatible with ZL70251 MAC with optional FEC and CRC	Yes	Opt	No	No	No	Opt
User	User-defined packet (no MAC header)	Yes	Opt	Yes	Yes	No	Opt
Z-Star	Fully functional MAC based on Microsemi's Z-Star protocol	Yes	Opt	Yes	Yes	Yes	Yes

3.1.1 Raw Bit Packet Mode

In raw bit mode, raw bits are transmitted without preamble, frame sync pattern, header, or CRC. If these properties are needed, then they must be encoded in the bit stream. The bit stream may be sourced from the TX buffer, from the GP3..0 pins, or generated from an internal pattern generator.

On the receiver side, the bit stream is received without frame synchronization or byte alignment. The received data either can be placed in the receive buffer or can be output with a clock on the GP3..0 pins.

Raw bit mode has two basic applications. First, it can be used for raw bit error testing using the GP3..0 pins. Second, it can be used for applications where the packet framing is not desired, or for data rates not supported by the ZL70550 device. There are limitations to this second case.

3.1.2 Raw Packet Mode

In raw packet mode, packets are transmitted without a MAC header, similar to the ZL70251 device. The CRC is optional but requires either a fixed-length packet or length information in the packet such that the application processor can dynamically extract the length from the beginning of the packet and change the RX packet length before the end of the packet is received.

The packet format is shown in Figure 3, page 6. If raw packet mode is used, then the TX and RX packet lengths are controlled by *tx_buf_len* and *rx_frm_len*, respectively. During reception, users may update *rx_frm_len*, providing this occurs before the end of the packet. Usually this requires users to embed the packet length as the first byte of the payload. The packet may optionally be terminated if the RSSI drops below the RSSI threshold setting or if a SPI Abort command is executed. In all cases, *rx_frm_len* indicates the length of the received packet.

Figure 3 • Packet Format, Raw Packet Mode

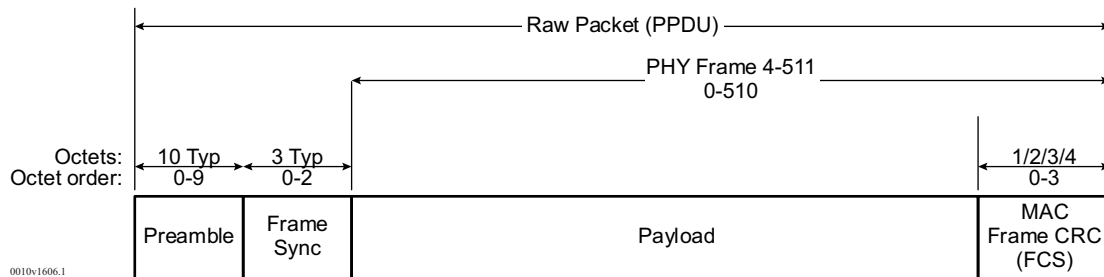

0010w1606.1

3.1.3 User Packet Mode

In user packet mode, packets are transmitted with a PHY header and optional FEC and CRC. The basic packet format is shown in Figure 4, page 7. The PHY header contains the length of the packet, which is used by the receiver to terminate the packet and calculate the CRC. The format of the PHY header in the received packet is flexible in that the length may be located at a programmable offset from the beginning of the PHY frame. It may be of various lengths and either MSB or LSB first.

For automatic PHY header generation on the transmit side, single-byte PHY headers are supported with LSB first by setting *tx_auto_hdr* equal to 1. For other formats, the PHY header must come from the transmit buffer.

Figure 4 • Packet Format, User Packet Mode

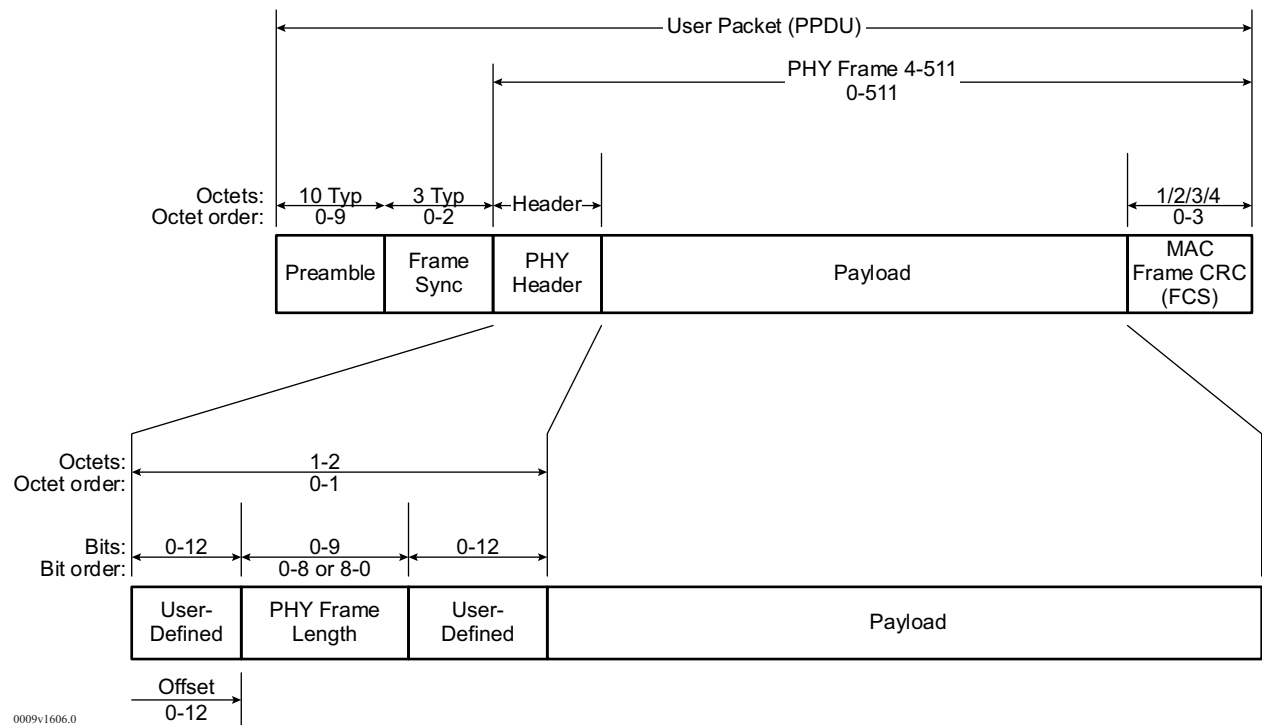

3.1.4 Z-Star Packet Mode

In Z-Star packet mode, packets are transmitted with a MAC header, a PHY header, either a 16-bit or 32-bit CRC (also known as a Frame Check Sequence (FCS)), and an option for using FEC. The basic packet format is shown in Figure 5, page 8. Z-Star packet mode supports the MAC layer of the Z-Star protocol as defined in the Z-Star protocol specification. The ZL70550 hardware performs the following Z-Star MAC functions:

- Automatic CSMA algorithm with random back off (LBT)
- Transmitting a packet with or without automatic acknowledgment reception
- Programmable automatic retransmissions
- Data request (node request to hub for data)
- Sniff with automatic packet reception or sleep (supports mesh networking)

The ZL70550 Z-Star MAC is a highly optimized and ultra-low-power protocol supporting a node/hub star network ideally suited for wireless sensor networks (WSNs) or Internet of things (IoT) applications. It is also highly flexible to support point-to-point transactions or other topologies. The combination of the highly optimized Z-Star MAC protocol and the best-in-class, ultra-low-power radio make the ZL70550 device the radio of choice where power efficiency is paramount.

Figure 5 • Packet Format, Z-Star Packet Mode

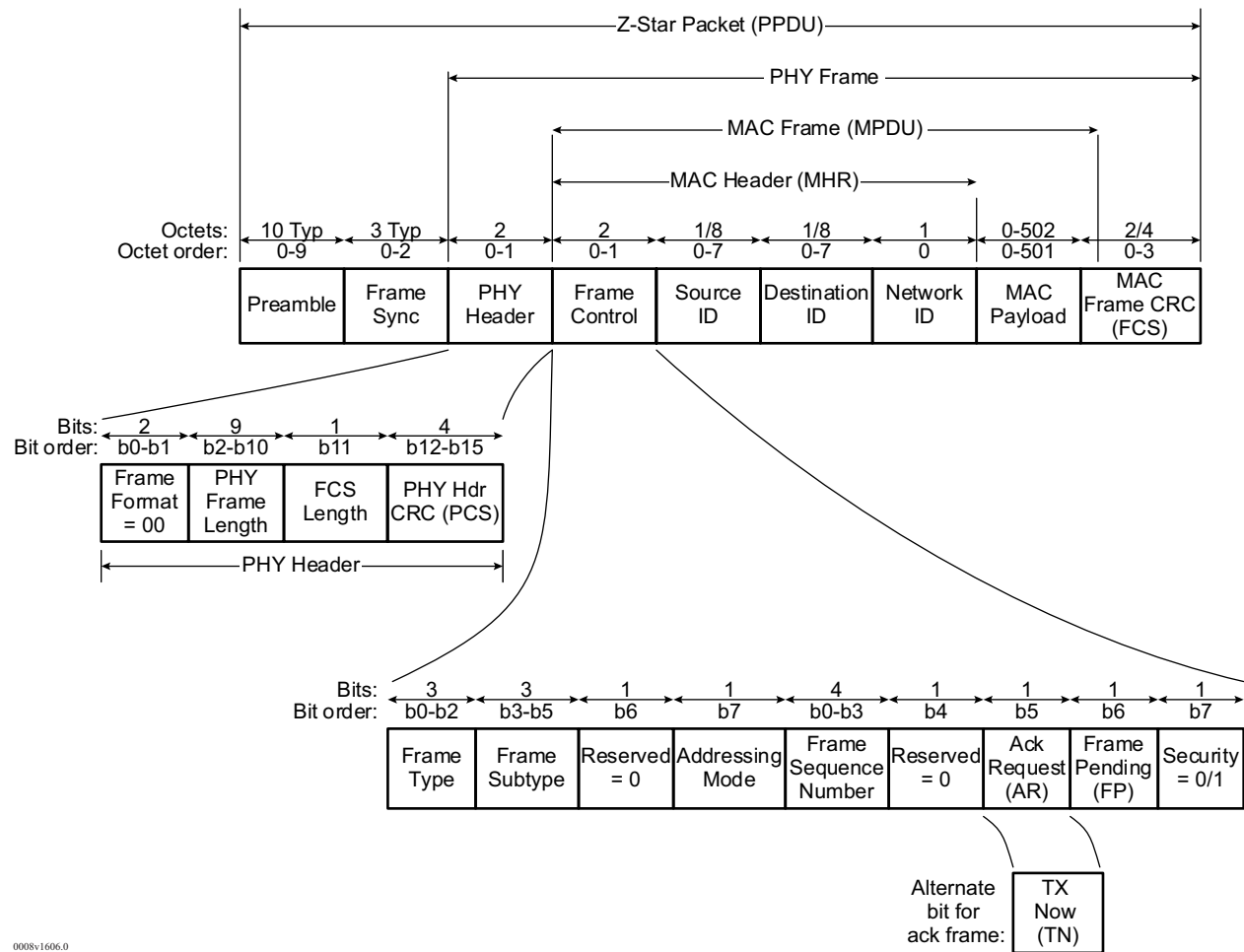

0008v1606.0

4 Electrical Specifications

Voltages are with respect to ground (VSS) unless otherwise stated.

4.1 Absolute Maximum Ratings

Table 2 • Absolute Maximum Ratings

Parameter	Symbol	Limits (Note 1)		Unit	Notes
		Min.	Max.		
Supply voltage	V _{SUP}	-0.3	3.6	V	Note 2
Digital I/O supply voltage	V _{DDIO}	-0.3	3.6	V	Note 2
Digital I/O voltage	V _{IOD}	V _{VSS} - 0.3	V _{DDIO} + 0.3	V	Note 3
Analog I/O voltage	V _{IOA}	V _{VSS} - 0.3	V _{SUP} + 0.3	V	Note 4
RF I/O voltage	V _{IORF}	V _{VSS} - 0.3	2 × V _{DDA}	V	Note 5
Storage temperature	T _{STG}	-40	85	°C	Unpowered
Electrostatic discharge (human body model)	V _{HBM}		500	V	RF and crystal pads; Note 6
			1500	V	All other pads; Note 6
Electrostatic discharge (charged-device model)	V _{CDM}		250	V	All pads

1. Performance is not guaranteed outside these limits. Application of voltage beyond the stated absolute maximum rating may permanently damage the device or cause reduced reliability.
2. Application of voltage beyond the stated absolute maximum rating may cause permanent damage to the device or cause reduced reliability.
3. Applies to digital interface pins including GP3.0, IRQ, RESET_B, SPI_CLK, SPI_MISO, SPI_MOSI, SPI_SEL_B, IO_MAP, SCAN_TEST, and TEST_SEL.
4. Applies to analog interface pins, including RBIAS, XTAL1, and XTAL2.
5. Applies to RF interface pins, including RF+, RF-, TX+, TX-, RX+, and RX-.
6. Applied one at a time. Exceeding these values may cause permanent damage. Functional operation under these conditions is not implied.

4.1.1 Recommended Operating Conditions

The recommended operating conditions define the nominal conditions for the device. This means that a specified parameter is valid for the recommended operating conditions stated in [Table 3](#), page 9, unless otherwise noted.

Table 3 • Recommended Operating Conditions

Parameter	Symbol	Limits (Note 1)			Unit	Notes
		Min.	Typ.	Max.		
Supply voltage	V _{DDOP}	1.71		3.6	V	
VDDIO	V _{DDIO}	1.71		3.5	V	
Operating temperature	T _{OP}	-40	25	85	°C	

1. Performance is not guaranteed outside these limits. Application of voltage beyond the stated absolute maximum rating may permanently damage the device or cause reduced reliability.

4.2 Electrical Characteristics

4.2.1 Voltage Regulators

Table 4 • Voltage Regulators

Parameter	Symbol	Limits			Unit	Note
		Min.	Typ.	Max.		
Output voltage range	V _{DDA}	1.46	1.52	1.57	V	Note 1
Output voltage range	V _{DDD}	1.20	1.25	1.30	V	Note 1

- Do not connect external circuits to these pins. V_{DDA} and V_{DDD} are regulated supplies for the internal analog and digital circuits, respectively, of the ZL70550 device.

4.2.2 Digital Interface

Table 5 • Digital I/O AC and DC Specifications

Parameter	Symbol	Limits		Unit	Note
		Min.	Max.		
High-level output voltage	V _{OH}	V _{DD} - 0.2		V	
Low-level output voltage	V _{OL}	V _{SS} + 0.2		V	
High-level input voltage	V _{IH}	V _{DDIO} × 0.85	V _{DDIO}	V	
Low-level input voltage	V _{IL}	V _{SSD}	V _{DDIO} × 0.15	V	
High-level output current	I _{OH}	1		mA	
Low-level output current	I _{OL}	1		mA	
Input leakage current	I _{LEAK}	-10	10	nA	Note 1
Output rise time (20% to 80%)	T _R	35		ns	Load of 120pF at 1mA
Output fall time (80% to 20%)	T _F	35		ns	Load of 120pF at 1mA

- Assumes that the GP3..0 pins are tied low and *not* in use. The GP3..0 pins have higher leakage above 2.7V.

4.2.3 Performance Characteristics

The specified performance of the ZL70550 device is valid over a supply range of 1.8V to 3.5V.

4.2.3.1 General RF Parameters

Table 6 • General Characteristics

Parameter	Limits			Unit	Note
	Min.	Typ.	Max.		
Operating frequency range	779		965	MHz	
Reference frequency		24		MHz	See Note 1
Symbol rate		200		kbit/s	300-kHz channel bandwidth
		100		kbit/s	300-kHz channel bandwidth
		50		kbit/s	300-kHz channel bandwidth
Channel separation		300		kHz	Note 2
Crystal oscillator startup time			1	ms	
Modulation index	0.45	0.5	0.55		Based on a raw data rate of 200kbit/s

1. In order to save power and reduce the number of external components, the crystal oscillator has a 3-pF load instead of a typical 8-pF or 10-pF load (refer to [Table 11](#), page 14). The 3-pF load is representative of the pin and PCB parasitic capacitance.
2. This is not an occupied bandwidth. It is based on the typical channel bandwidth; however, other channel bandwidths can be programmed.

4.2.3.2 Current Consumption

Table 7 • Current Consumption

Parameter	Symbol	Limits			Unit	Note
		Min.	Typ.	Max.		
SLEEP state current	I_{SLEEP}		10	50	nA	Partial register retention only
IDLE state current	I_{IDLE}		200	300	μ A	Crystal oscillator running only
			2.4		mA	LNA gain=8'h0F, LNA bias=8'h05
RX state current	I_{RX}		3.2		mA	LNA gain=8'h0F, LNA bias=8'h29
			5.3		mA	0dBm into a 50- Ω load
TX state current (CW on 916MHz)	I_{TX}		2.75		mA	-10dBm into a 50- Ω load
			2.4		mA	
RSSI sniff current	I_{SNIFF}		2.4		mA	

4.2.3.3 Synthesizer

Table 8 • Synthesizer

Parameter	Symbol	Limits			Unit	Note
		Min.	Typ.	Max.		
Phase noise at 100kHz	$\Phi_{\text{SYNTH_100k}}$		-92		dBc/Hz	CW observed from PA
Reference spurs	$\Psi_{\text{SYNTH_CLRS}}$		-60		dBc	At 300kHz (25°C); CW from PA

4.2.3.4 Transmitter

Table 9 • Transmitter RF Characteristics

Parameter	Condition	Limits			Unit	Note
		Min.	Typ.	Max.		
Output power	PA=maximum setting		0		dBm	Measured on ADK (50Ω match); no SAW filter (for typical values refer to Figure 7 , page 15)
	PA=minimum setting		-25		dBm	
Spurious emissions				-33	dBm	
TX-RX or RX-TX turnaround time			820		μs	Programmable Highest data rate See Note 1

1. Last bit of previous packet to first bit of subsequent packet header.

4.2.3.5 Receiver

Table 10 • Receiver RF Characteristics

Parameter	Limits			Unit	Note
	Min.	Typ.	Max.		
Sensitivity at 25°C, 1.8V		-106		dBm	50kbit/s with $I_{RX}=3.2\text{mA}$ (LNA gain=8'h0F, LNA bias=8'h29) with FEC
		-103		dBm	50kbit/s with $I_{RX}=2.4\text{mA}$ (LNA gain=8'h0F, LNA bias=8'h05) with FEC
		-99		dBm	200kbit/s with $I_{RX}=3.2\text{mA}$ (LNA gain=8'h0F, LNA bias=8'h29) without FEC
		-95		dBm	200kbit/s with $I_{RX}=2.4\text{mA}$ (LNA gain=8'h0F, LNA bias=8'h05) without FEC
Maximum input power	-34			dBm	200kbit/s with $I_{RX}=2.4\text{mA}$ (LNA gain=8'h0F, LNA bias=8'h05) with FEC
Cascaded voltage gain		30		dB	LNA and mixer; programmable, with five settings in 3-dB to 4-dB steps ($I_{RX}=2.4\text{mA}$)
IF center frequency		600		kHz	(300kHz × 2)
RSSI range		42		dB	Linear range (± 1 LSB) Digital, 32 levels of 2dB
RSSI resolution		2		dB	Note 1
RSSI accuracy		± 2		dB	Note 2
Listen Before Talk (LBT) minimum level			-100	dB	
Adjacent channel rejection		11		dB	Relative to sensitivity Desired channel 3dB above the sensitivity limit; 300-kHz channel spacing with a modulated interferer
Alternate channel rejection		25		dB	Relative to sensitivity Desired channel 3dB above the sensitivity limit; 600-kHz channel spacing with a modulated interferer
Blocker rejection	11			dB	At $\pm 2\text{MHz}$, EN300 200 limits
	31			dB	At $\pm 10\text{MHz}$, EN300 200 limits
1-dB compression		-43		dBm	LNA gain=8'h0F
Third-order input intercept point		-36		dBm	LNA gain=8'h0F

1. Nominal ADC quantization. The average RSSI results have seven bits rather than five if the averaging length is four or more. The accuracy in this case is $\pm 0.5\text{dB}$ due to the dithering/averaging of noise at lower levels where LBT thresholds are set.
2. Calibrated at one LNA gain, one temperature and one input level (for LBT).

4.2.3.6 Crystal Oscillator

All frequency-related specifications are based on the crystal oscillator performance, which, in turn, is dependent on the crystal specifications. The ZL70550 device specifications assume that the crystal specifications listed in the following table are met or exceeded (refer to Table 11, page 14). The crystal oscillator is trimmable to ± 5 ppm at room temperature when attached to a crystal meeting the specifications in Table 11, page 14.

Table 11 • Crystal Specifications

Parameter	Limits			Unit	Note
	Min.	Typ.	Max.		
Frequency		24		MHz	
Frequency tolerance	-30		30	ppm	
Stability with temperature	-25		25	ppm	Over operating temperature
Operating temperature range	-40	25	85	°C	
Equivalent series resistance	12		130	ohm	
Motional resistance	0	1	17	ohm	
Shunt capacitance	1.4	1.65	1.9	pF	Note 1
Motional capacitance	3.2	3.35	3.5	fF	Note 1
Load capacitance		3		pF	Note 2
Drive level			50	μ W	
Aging	-3		3	ppm	First year only; none thereafter

1. A low shunt capacitance and high motional capacitance is best as it results in a larger trim range.
2. In order to save power, the crystal oscillator presents a 3-pF load instead of the typical 8-pF or 10-pF load. A slight frequency pull, on the order of 100ppm to 150ppm, would result if using a standard crystal without additional external load capacitors. Such a deviation has no effect on the operation of the device and is generally not a problem for most applications, providing all ZL70550 devices have the same frequency pull (within trimmable range). If the deviation is not acceptable and power is critical, a special cut crystal may be used (that is, slightly slower to compensate for the pull). Microsemi is engaging with crystal manufacturers in developing custom crystals that operate at 24MHz with only a 3-pF load.

Figure 6 • Crystal Oscillator Circuit

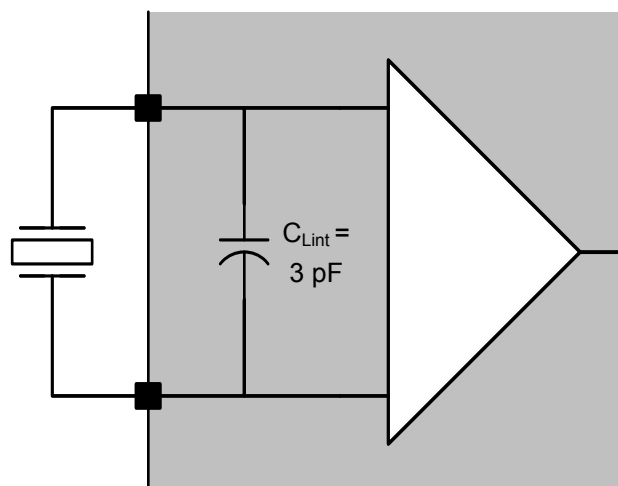

0026-Xtal diagram-v1606.0

4.3 Transmit Power Characteristics

The following figures illustrate the relationship between TX power, PA trim setting, and current consumption (refer to [Figure 7](#), page 15, and [Figure 8](#), page 15). These measurements were made on the REMOTE550 board from a ZL70550 Application Development Kit (ADK) at room temperature and with a supply voltage of 1.8V. The figures include the losses of the matching network (approximately 2 dB to 3dB).

4.3.1 Transmit Power vs. PA Trim Value

Figure 7 • TX Power vs. PA Trim Value

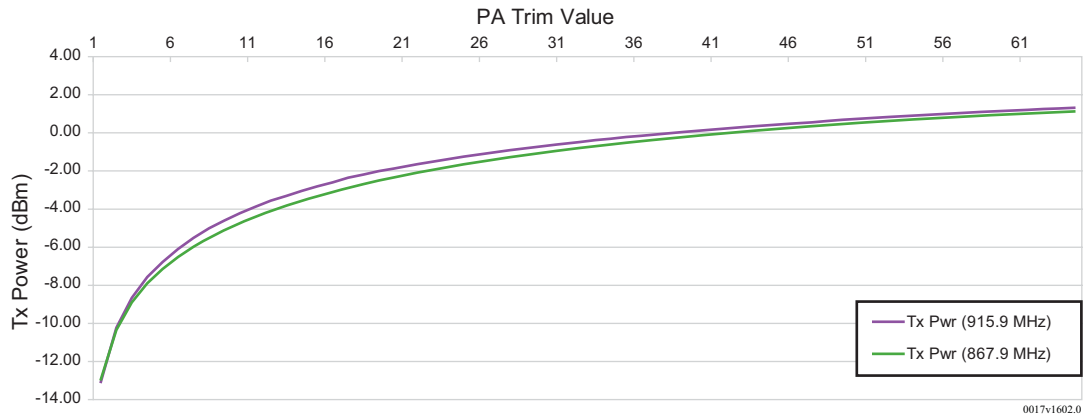

4.3.2 Transmit Power vs. Current Consumption

Figure 8 • TX Power vs. Current Consumption

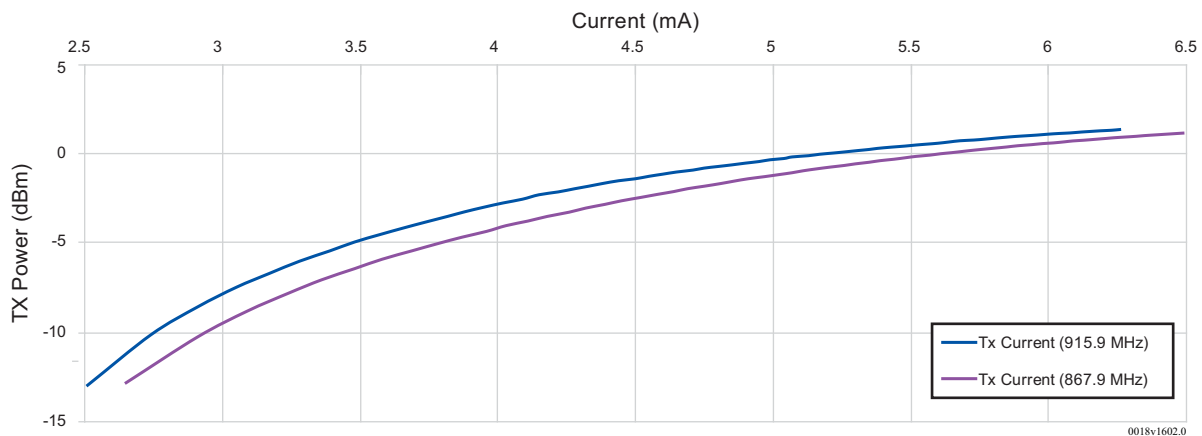

5 Pin Descriptions

The ZL70550 device is available in two package options, a 32-pin QFN and a 29-pin CSP. The pins are described in this section.

5.1 Pin Diagrams

The following illustrations are representations of the QFN and CSP packages, respectively, for the ZL70550 device.

Figure 9 • Footprint (top view) for 32-Pin QFN

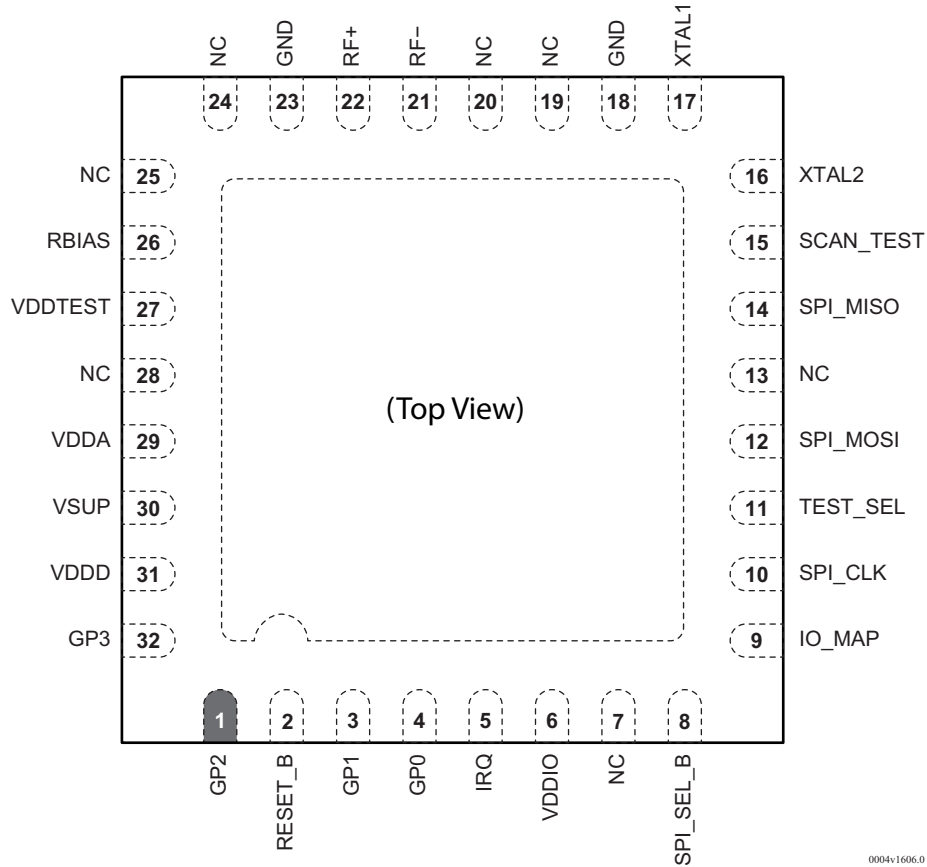
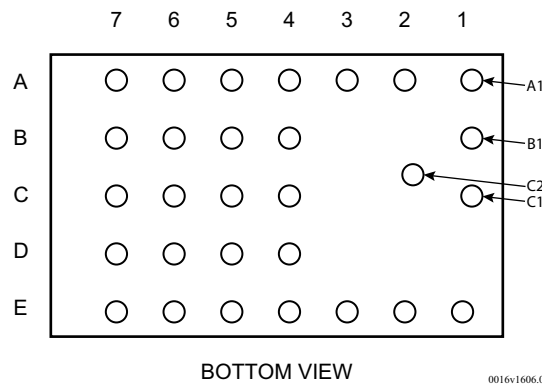

Figure 10 • Footprint (bottom view) for 29-Pin CSP Package



5.2 Pin Lists

The pinouts for the QFN and CSP packages of the ZL70550 device are listed in [Table 12](#), page 17, and [Table 13](#), page 18, respectively.

Connect the QFN center pad/paddle to the ground plane of the PCB. A minimum of four vias between the SMD pad and the ground plane are recommended to ensure reliable performance.

For the QFN, pins 18 and 23 must be connected to the PCB ground plane as well (refer to [Table 12](#), page 17).

Table 12 • Pinout for 32-Pin QFN

Pin Name ¹	Pin Number	Pin Name ¹	Pin Number
GP2	1	GND	18
RESET_B	2	NC	19
GP1	3	NC	20
GP0	4	RF-	21
IRQ	5	RF+	22
VDDIO	6	GND	23
NC	7	NC	24
SPI_SEL_B	8	NC	25
IO_MAP	9	RBIAS	26
SPI_CLK	10	VDDTEST	27
TEST_SEL	11	NC	28
SPI_MOSI	12	VDDA	29
NC	13	VSUP	30
SPI_MISO	14	VDDD	31
SCAN_TEST	15	GP3	32
XTAL2	16	Paddle/GND	N/A
XTAL1	17		

1. NC denotes reserved pin. Do not use; do not connect.

Table 13 • Pinout for 29-Pin CSP

Pin Name	Pin Number	Pin Name	Pin Number
RX+	A1	GP0	C6
RBIAS	A2	IRQ	C7
VDDTEST	A3	TX-	C1
VSSA	A4	SCAN_TEST	D4
VDDA	A5	TEST_SEL	D5
VDDD	A6	IO_MAP	D6
GP3	A7	VDDIO	D7
TX+	B1	VSSA2	E1
GP1	B4	XTAL1	E2
VSUP	B5	XTAL2	E3
GP2	B6	SPI_MISO	E4
RESET_B	B7	SPI_MOSI	E5
RX-	C2	SPI_CLK	E6
VSSD	C4	SPI_SEL_B	E7
VSSD2	C5		

5.3 Functional Pin Descriptions

The following table shows the functional pin descriptions for the ZL70550 device.

Table 14 • Overview of ZL70550 Interconnects

Symbol	I/O	Type	Description
Interconnects Available on All Package Options			
GP0	I/O	A/D	Analog and digital test bus input and output. General-purpose use for digital I/O.
GP1	I/O	A/D	Analog and digital test bus input and output. General-purpose use for digital I/O.
GP2	I/O	A/D	Analog and digital test bus input and output. General-purpose use for digital I/O.
GP3	I/O	A/D	Analog and digital test bus input and output. General-purpose use for digital I/O.
IO_MAP	I	D	Connect to ground. Used for device testing only.
IRQ	O	D	Interrupt output.
NC	N/A	N/A	No connection (do not ground pin).
RBIAS	I	A	Bias setting resistor used to trim the internal current reference. Use a 49.9-kohm resistor ($\pm 1\%$) to ground.
RESET_B	I	D	Asynchronous reset (active low) with a minimum low period of 100ns. When low, the ZL70550 is in reset and all circuits are off. When transitioning from low to high, all registers are set to their power-on-reset values, the crystal oscillator starts up, all other circuits are disabled, and the ZL70550 enters into the IDLE state.
SCAN_TEST	I	D	Connect to ground. Used for device testing only.
SPI_CLK	I	D	SPI bus clock input.

Table 14 • Overview of ZL70550 Interconnects (continued)

Symbol	I/O	Type	Description
SPI_MISO	O	D	SPI bus data output. This output is tri-stated when SPI_SEL_B is high and driven when SPI_SEL_B is low.
SPI_MOSI	I	D	SPI bus data input.
SPI_SEL_B	I	D	SPI bus select input (active low). When low, the SPI_MISO output buffer is enabled.
TEST_SEL	I	D	Connect to ground. Used for device testing only.
VDDA	O	A	1.52-volt regulator output used to power most on-chip analog circuits. Connect a 100-nF X7R ceramic capacitor between VDDA and ground.
VDDD	O	A/D	1.25-volt regulator output used to power most on-chip digital circuits. Connect a 100-nF X7R ceramic capacitor between VDDD and ground.
VDDIO	I	A/D	Power supply input to the internal level shifters (1.71 volts to 3.6 volts). Controls the digital signaling level for all ZL70550 digital I/O.
VDDTEST	I	A	Connect to ground. Used for device testing only.
VSUP	I	A/D	Supply voltage (1.71 volts to 3.6 volts).
XTAL1	I	A	Crystal connection to the gate (input) of the crystal oscillator. Can also be driven with an external clock source.
XTAL2	O	A	Crystal connection to the drain (output) of the crystal oscillator.
RF and Ground Connections on QFN Package			
Paddle/GND	I	A/D	Ground connection.
GND	I	A/D	Ground connection.
RF+	I/O	A	RF positive (TX/RX). TX+ and RX+ are bonded together.
RF-	I/O	A	RF negative (TX/RX). TX- and RX- are bonded together.
RF and Ground Connections on CSP Package			
RX+	I	A	Receiver RF positive input. This input is AC coupled and is connected to an internal shunt capacitor that can be used for automatic tuning to antennas or matching networks that connect directly to the receiver inputs.
RX-	I	A	Receiver RF negative input. This input is AC coupled and is connected to an internal shunt capacitor that can be used for automatic tuning to antennas or matching networks that connect directly to the receiver inputs.
TX+	O	A	Transmitter RF positive output. Requires external biasing to VDDA.
TX-	O	A	Transmitter RF negative output. Requires external biasing to VDDA.
VSSA	I	A	Ground connection.
VSSA2	I	A	Ground connection.
VSSD	I	A	Ground connection.
VSSD2	I	A	Ground connection.

6 Package Information

6.1 Drawing and Markings for 32-Pin QFN Package

Figure 11 • Package Drawing and Package Dimensions for 32-Pin QFN

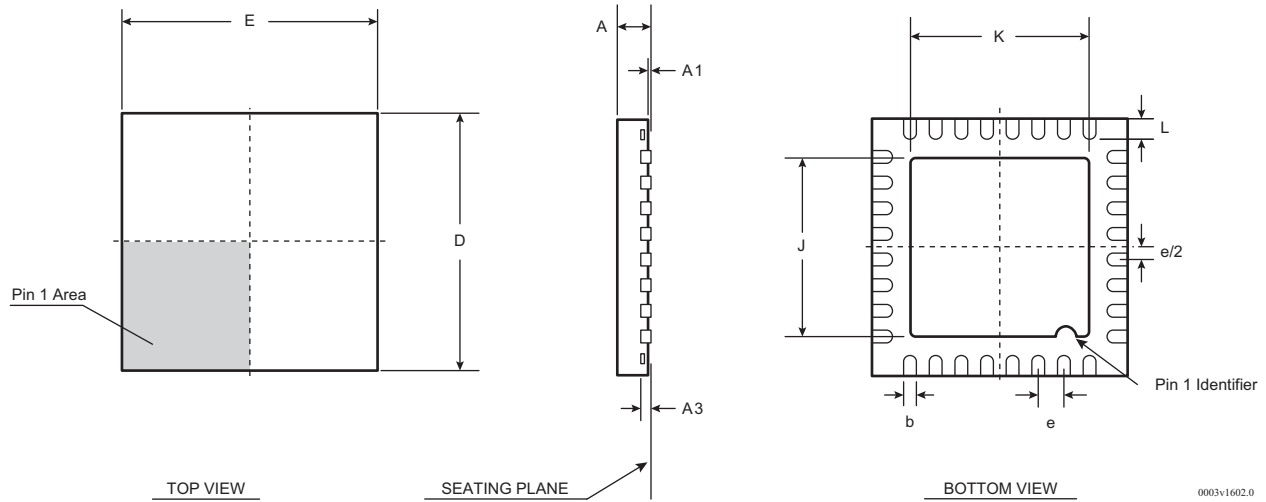

Common Dimensions			
Symbol	Minimum	Nominal	Maximum
A	0.8	0.9	1.0
A1	0	0.02	0.05
A3		0.2	
b	0.20	0.25	0.30
D		5.00	
E		5.00	
e		0.50	
J	3.40	3.50	3.60
K	3.40	3.50	3.60
L	0.35	0.40	0.45

Notes:

1. Dimensioning and tolerances conform to ASME Y14.5M. – 1994.
2. All dimensions are in millimeters.
3. Not to scale.

Figure 12 • Markings for 32-Pin QFN

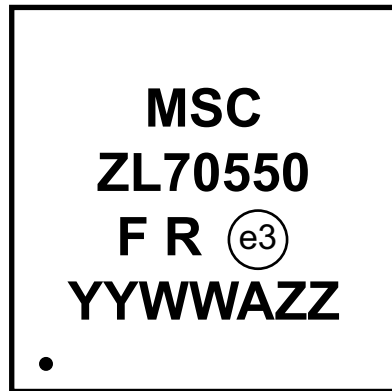

Pin 1 Corner

0006v1602.0

Notes:

1. YY = Last two digits of year of encapsulation
2. WW = Week number of encapsulation
3. ZZ = Assembly lot sequence code
4. A = Assigned Assembly Site Identifier
5. F = Fab code
6. R = Product revision code
7. e3 = Denotes Pb-free

6.2 Drawing and Markings for 29-Pin CSP Package

Figure 13 • Package Drawing and Package Dimensions for 29-Pin CSP

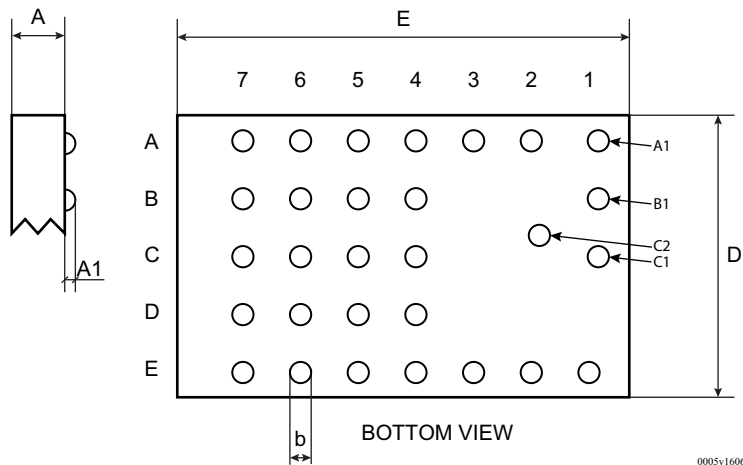

0005v1606.0

Common Dimensions (mm)		
Symbol	Minimum	Nominal Maximum
A		0.317
A1		0.115
b ¹		0.150
D		1.99
E		3.085

Notes:

1. UBM diameter
2. For pin coordinates, refer to Table 15, page 22

Table 15 • Pin Coordinates for PCB Layout for 29-Pin CSP (top-down view)

Ball	Distance from Center of Die in μm	
	X Coordinate	Y Coordinate
A1	1347.0050	800.5200
A2	887.0050	800.5200
A3	487.0050	800.5200
A4	87.0050	800.5200
A5	-312.9950	800.5200
A6	-712.9950	800.5200
A7	-1112.9950	800.5200
B1	1347.0050	400.5200
B4	87.0050	400.5200
B5	-312.9950	400.5200
B6	-712.9950	400.5200
B7	-1112.9950	400.5200
C1	1347.0050	0.5200
C2	941.0050	144.5200
C4	87.0050	0.5200
C5	-312.9950	0.5200
C6	-712.9950	0.5200
C7	-1112.9950	0.5200
D4	87.0050	-399.4800
D5	-312.9950	-399.4800
D6	-712.9950	-399.4800
D7	-1112.9950	-399.4800
E1	1287.0050	-799.4800
E2	887.0050	-799.4800
E3	487.0050	-799.4800
E4	87.0050	-799.4800
E5	-312.9950	-799.4800
E6	-712.9950	-799.4800
E7	-1112.9950	-799.4800

Figure 14 • Markings for 29-Pin CSP

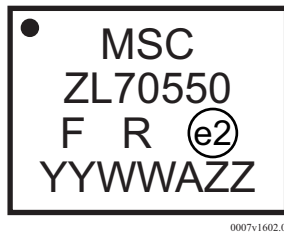

Notes:

1. YY = Last two digits of year of encapsulation
2. WW = Week number of encapsulation
3. ZZ = Assembly lot sequence code
4. A = Assigned Assembly Site Identifier
5. F = Fab code
6. R = Product revision code
7. e2 = Denotes Pb-free
8. Orientation marker corresponds to pin A1

7 Ordering Information

The ZL70550 RF transceiver is available in two package options.

Table 16 • Ordering and Package Overview

Ordering Code	Temp Range (°C)	Package	Delivery Form	Pb-Free
ZL70550LDF1	-40 to 85	32-pin QFN	Tape and reel	YES ¹
ZL70550UGB4 (contact Microsemi for availability)	-40 to 85	29-pin CSP	Tape and reel	YES ²

1. Matte tin.
2. Sn/Ag (97.5 percent tin, 2.5 percent silver).