

# 6 PIN DIP PHOTOTRANSISTOR PHOTOCOUPLER

# CNY17-X Series CNY17F-X Series

## Features

- Current transfer ratios in selected narrow range groups  
 CNY17-1, CNY17F-1: 40-80%  
 CNY17-2, CNY17F-2: 63-125%  
 CNY17-3, CNY17F-3: 100-200%  
 CNY17-4, CNY17F-4: 160-320%
- High isolation voltage between input and output  
 (Viso = 5000 Vrms)
- Creepage distance > 7.6 mm
- Operating temperature up to +110°C
- The CNY17F-X series offers no external base connection  
 for minimum noise susceptibility
- Compact dual-in-line package
- Pb free and RoHS compliant.
- UL approved (No. E214129)
- VDE approved (No. 132249)
- SEMKO approval pending
- NEMKO approval pending
- DEMKO approval pending
- FIMKO approval pending
- CSA approval pending



### Schematic

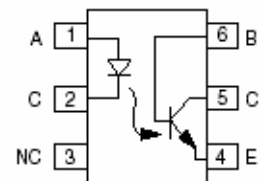

CNY17-X

1. Anode
2. Cathode
3. No Connection
4. Emitter
5. Collector
6. Base

## Description

The CNY17-X series and CNY17F-X series contains an infrared emitting diode optically coupled to a phototransistor. It is packaged in a 6-pin DIP package and available in wide-lead spacing and SMD option.

## Applications

- Power supply regulators
- Digital logic inputs
- Microprocessor inputs

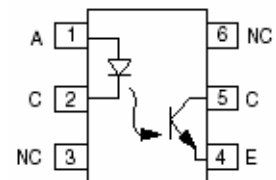

CNY17F-X

1. Anode
2. Cathode
3. No Connection
4. Emitter
5. Collector
6. No Connection

## 6 PIN DIP PHOTOTRANSISTOR PHOTOCOUPLER

## CNY17-X Series CNY17F-X Series

### Absolute Maximum Ratings ( $T_a=25^\circ\text{C}$ )

Parameter		Symbol	Rating	Unit
Input	Forward current	$I_F$	60	mA
	Peak forward current ( $t = 10\mu\text{s}$ )	$I_{FM}$	1	A
	Reverse voltage	$V_R$	6	V
	Power dissipation ( $T_A = 25^\circ\text{C}$ )	$P_D$	70	mW
	Derating factor (above $100^\circ\text{C}$ )		3.8	mW/ $^\circ\text{C}$
Output	Collector-Emitter voltage	$V_{CEO}$	80	V
	Collector-Base voltage <sup>*1</sup>	$V_{CBO}$	80	V
	Emitter-Collector voltage	$V_{ECO}$	7	V
	Power dissipation ( $T_A = 25^\circ\text{C}$ )	$P_C$	150	mW
	Derating factor (above $100^\circ\text{C}$ )		9.0	mW/ $^\circ\text{C}$
Total power dissipation		$P_{tot}$	200	mW
Isolation voltage <sup>*2</sup>		$V_{iso}$	5000	V <sub>rms</sub>
Operating temperature		$T_{opr}$	-55~+110	$^\circ\text{C}$
Storage temperature		$T_{stg}$	-55~+125	$^\circ\text{C}$
Soldering temperature <sup>*3</sup>		$T_{sol}$	260	$^\circ\text{C}$

#### Notes

\*1 Only for CNY17-X series.

\*2 AC for 1 minute, R.H.= 40 ~ 60% R.H. In this test, pins 1, 2 & 3 are shorted together, and pins 4, 5 & 6 are shorted together.

\*3 For 10 seconds.

## 6 PIN DIP PHOTOTRANSISTOR PHOTOCOUPLER

## CNY17-X Series CNY17F-X Series

### Electrical Characteristics ( $T_a=25^\circ\text{C}$ unless specified otherwise)

#### Input

Parameter	Symbol	Min.	Typ.*	Max.	Unit	Condition
Forward voltage	$V_F$	-	-	1.65	V	$I_F = 60\text{mA}$
Reverse current	$I_R$	-	-	10	$\mu\text{A}$	$V_R = 6\text{V}$
Input capacitance	$C_{in}$	-	18	-	pF	$V = 0, f = 1\text{MHz}$

#### Output

Parameter	Symbol	Min.	Typ.*	Max.	Unit	Condition
Collector-Base dark current	CNY17-X only $I_{CBO}$	-	-	20	nA	$V_{CB} = 10\text{V}, I_F = 0\text{mA}$
Collector-Emitter dark current	$I_{CEO}$	-	-	50	nA	$V_{CE} = 10\text{V}, I_F = 0\text{mA}$
Collector-Emitter breakdown voltage	$BV_{CEO}$	80	-	-	V	$I_C = 1\text{mA}, I_F = 0\text{mA}$
Collector-Base breakdown voltage	CNY17-X only $BV_{CBO}$	80	-	-	V	$I_C = 0.1\text{mA}, I_F = 0\text{mA}$
Emitter-Collector breakdown voltage	$BV_{ECO}$	7	-	-	V	$I_E = 0.1\text{mA}, I_F = 0\text{mA}$
Collector-Emitter capacitance	$C_{CE}$	-	8	-	pF	$V_{CE} = 0\text{V}, f = 1\text{MHz}$

\* Typical values at  $T_a = 25^\circ\text{C}$



LIGHTING FOREVER

# 6 PIN DIP PHOTOTRANSISTOR PHOTOCOUPLER

# CNY17-X Series CNY17F-X Series

## Transfer Characteristics ( $T_a=25^\circ\text{C}$ unless specified otherwise)

Parameter		Symbol	Min.	Typ.*	Max.	Unit	Condition
Current Transfer Ratio	CNY17-1 CNY17F-1	CTR	40	-	80	%	$I_F = 10\text{mA}, V_{CE} = 5\text{V}$
	CNY17-2 CNY17F-2		63	-	125		
	CNY17-3 CNY17F-3		100	-	200		
	CNY17-4 CNY17F-4		160	-	320		
Current Transfer Ratio	CNY17-1 CNY17F-1	CTR	13	-	-	%	$I_F = 1\text{mA}, V_{CE} = 5\text{V}$
	CNY17-2 CNY17F-2		22	-	-		
	CNY17-3 CNY17F-3		34	-	-		
	CNY17-4 CNY17F-4		56	-	-		
Collector-Emitter saturation voltage		$V_{CE(sat)}$	-	-	0.3	V	$I_F = 10\text{mA}, I_C = 2.5\text{mA}$
Isolation resistance		$R_{IO}$	$10^{11}$	-	-	$\Omega$	$V_{IO} = 500\text{Vdc}$
Input-output capacitance		$C_{IO}$	-	0.5	-	pF	$V_{IO} = 0, f = 1\text{MHz}$
Turn-on time		$T_{on}$	-	10	12	$\mu\text{s}$	$V_{CC} = 10\text{V}, I_C = 2\text{mA}, R_L = 100\Omega$ See Fig. 11
Turn-off time		$T_{off}$	-	9	12		
Rise time		$T_r$	-	6	10		
Fall time		$T_f$	-	8	10		
Rise time		$T_r$	-	2	10		$V_{CC} = 5\text{V}, I_F = 10\text{mA}, R_L = 75\Omega$ , See Fig. 11
Fall time		$T_f$	-	3	10		

\* Typical values at  $T_a = 25^\circ\text{C}$



LIGHTING FOREVER

# 6 PIN DIP PHOTOTRANSISTOR PHOTOCOUPLER

# CNY17-X Series CNY17F-X Series

## Typical Performance Curves

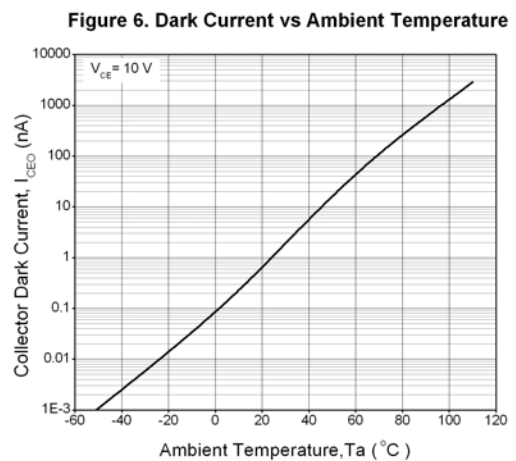
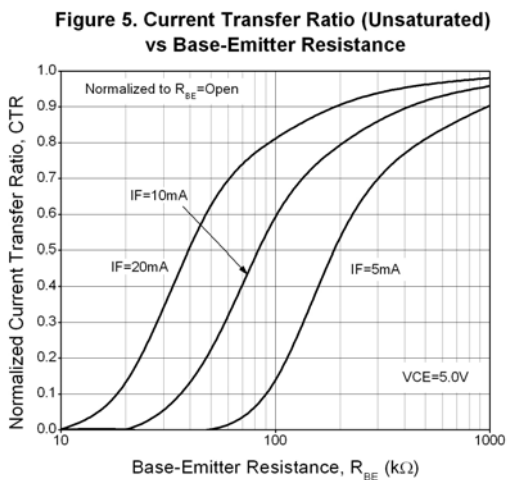
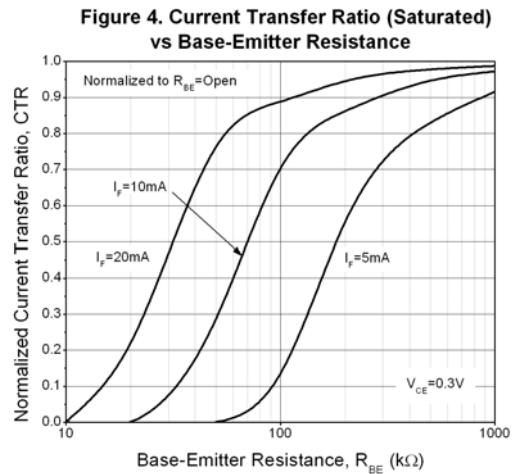
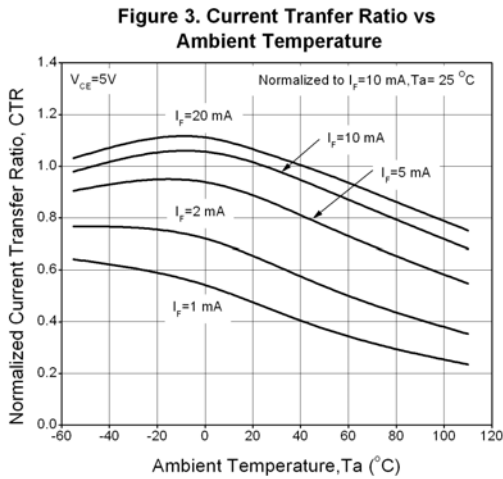
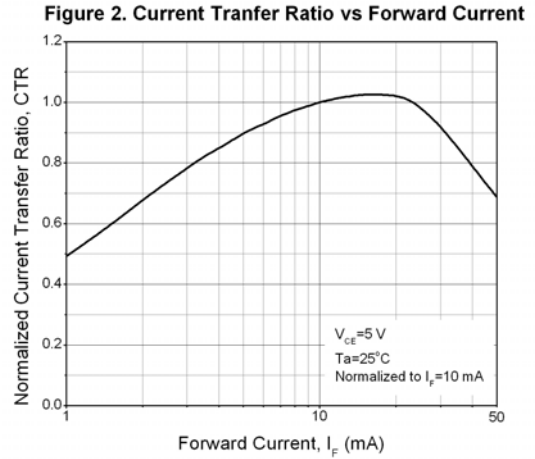
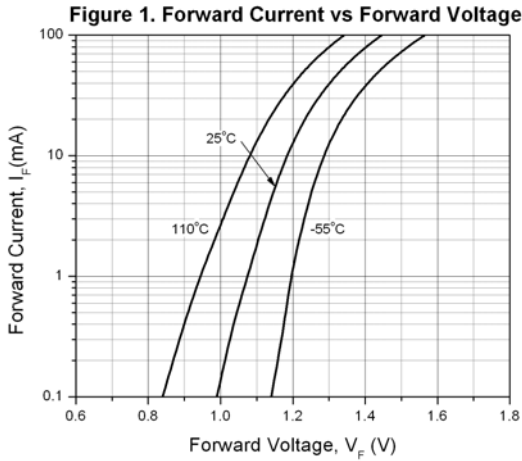

# 6 PIN DIP PHOTOTRANSISTOR PHOTOCOUPLER

# CNY17-X Series CNY17F-X Series

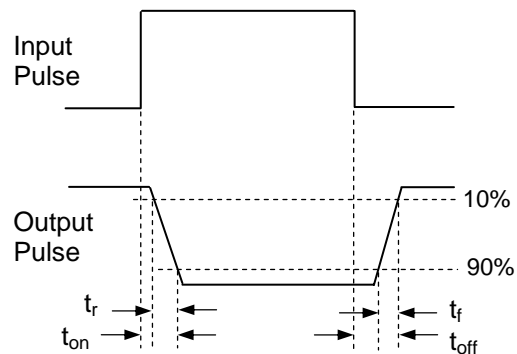
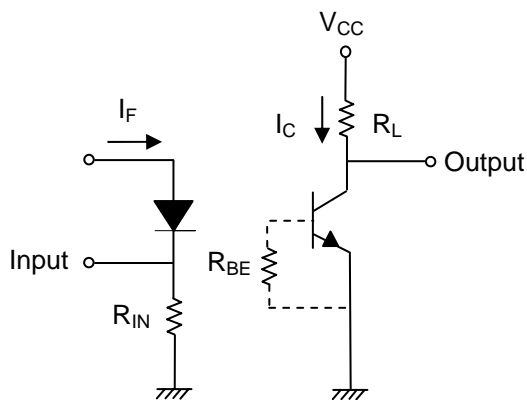
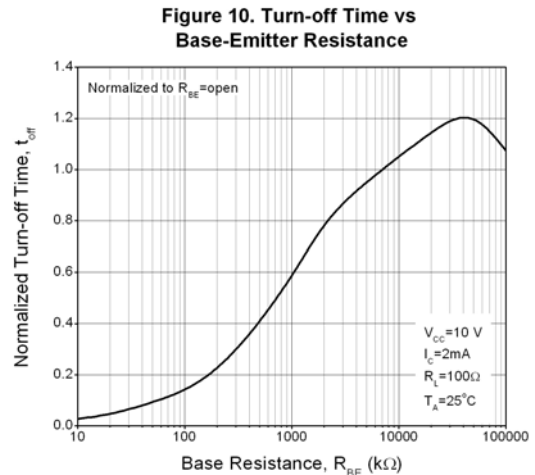
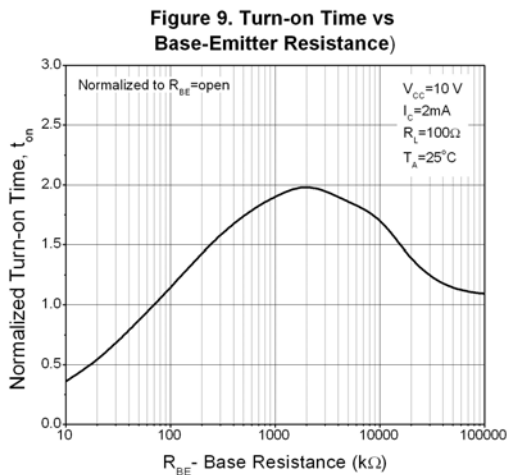
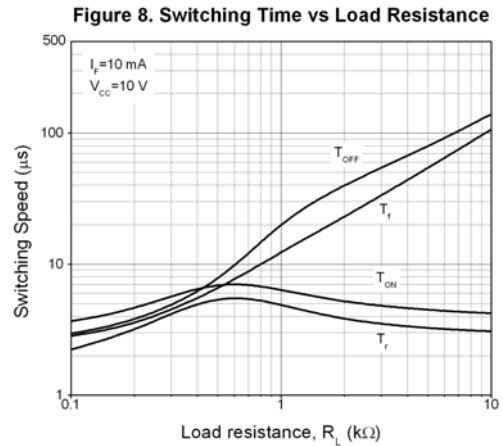
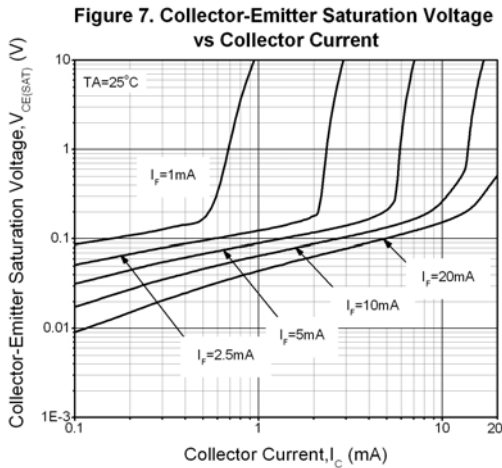

**Figure 11. Switching Time Test Circuit & Waveforms**



LIGHTING FOREVER

# 6 PIN DIP PHOTOTRANSISTOR PHOTOCOUPLER

CNY17-X Series  
CNY17F-X Series

## Order Information

### Part Number

**CNY17-XY(Z)-V**

or

**CNY17F-XY(Z)-V**

### Note

- X = Part no. (1, 2, 3 or 4)
- Y = Lead form option (S, S1, M or none)
- Z = Tape and reel option (TA, TB or none).
- V = VDE (optional)

Option	Description	Packing quantity
None	Standard DIP-6	65 units per tube
M	Wide lead bend (0.4 inch spacing)	65 units per tube
S (TA)	Surface mount lead form + TA tape & reel option	1000 units per reel
S (TB)	Surface mount lead form + TB tape & reel option	1000 units per reel
S1 (TA)	Surface mount lead form (low profile) + TA tape & reel option	1000 units per reel
S1 (TB)	Surface mount lead form (low profile) + TB tape & reel option	1000 units per reel



LIGHTING FOREVER

# 6 PIN DIP PHOTOTRANSISTOR PHOTOCOUPLER

## CNY17-X Series CNY17F-X Series

### Package Drawings

(Dimensions in mm)

#### Standard DIP Type

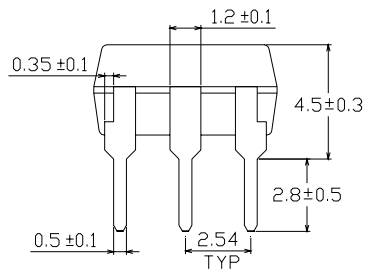
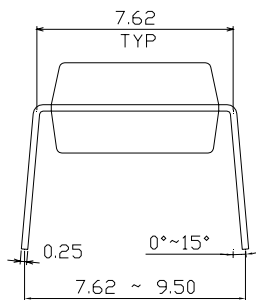
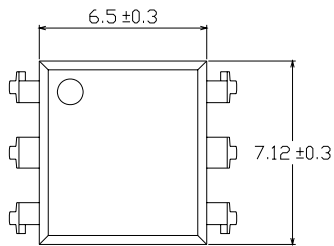

#### Option M Type

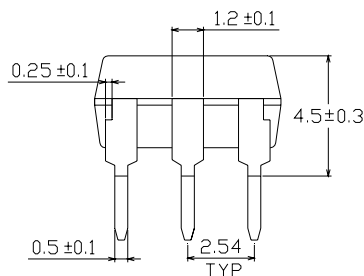
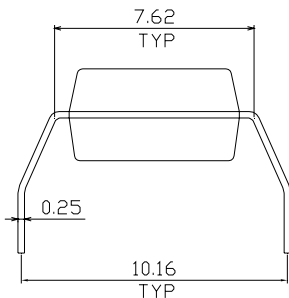
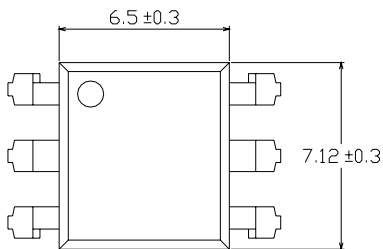



LIGHTING FOREVER

# 6 PIN DIP PHOTOTRANSISTOR PHOTOCOUPLER

## CNY17-X Series CNY17F-X Series

### Option S Type

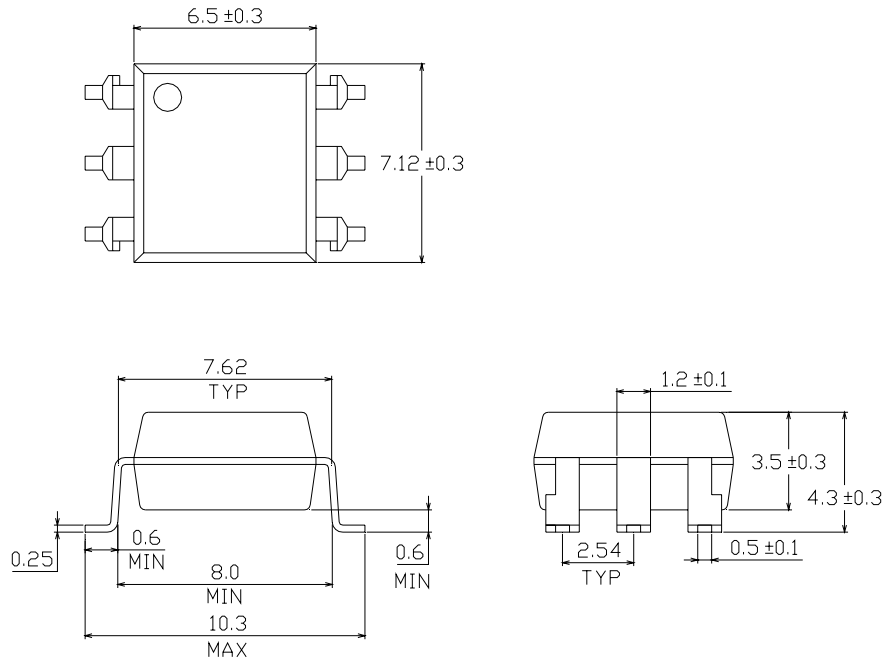

### Option S1 Type

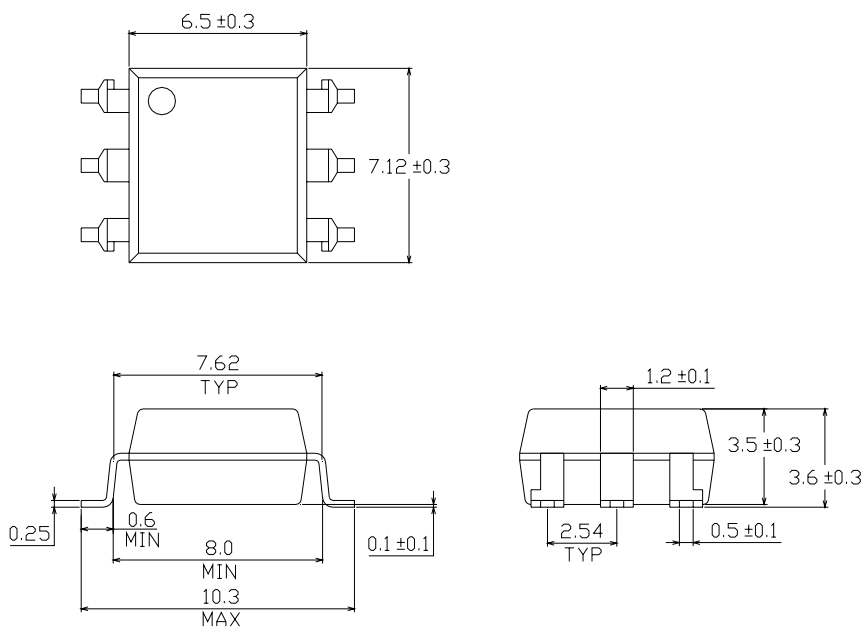



LIGHTING FOREVER

# 6 PIN DIP PHOTOTRANSISTOR PHOTOCOUPLER

## CNY17-X Series CNY17F-X Series

Recommended pad layout for surface mount leadfrom

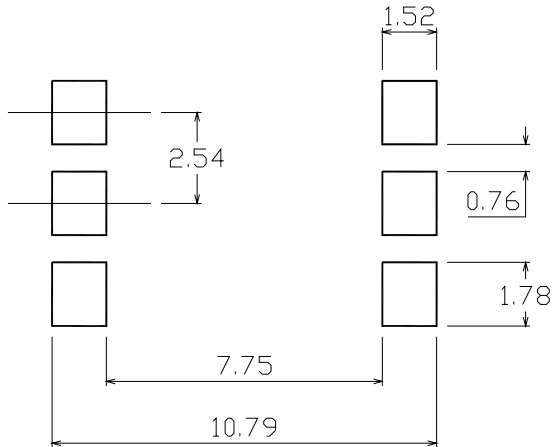

### Device Marking

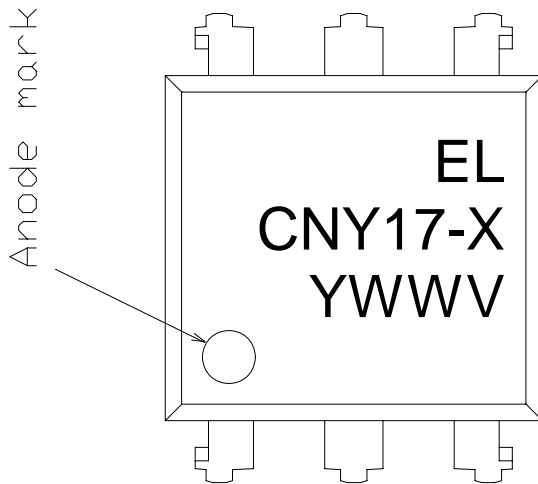

### Notes

- EL denotes Everlight
- CNY17-X denotes Device Number (X: 1, 2, 3 or 4)
- Y denotes 1 digit Year code
- WW denotes 2 digit Week code
- V denotes VDE (optional)

# 6 PIN DIP PHOTOTRANSISTOR PHOTOCOUPLER

# CNY17-X Series CNY17F-X Series

## Tape & Reel Packing Specifications

**Option TA**

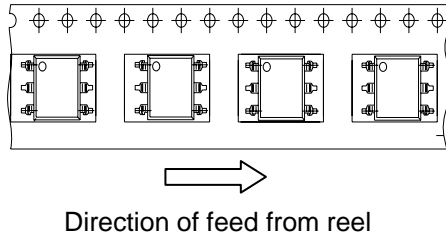

**Option TB**

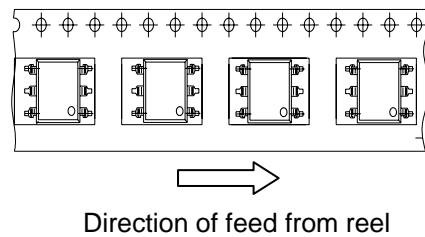

## Tape dimensions

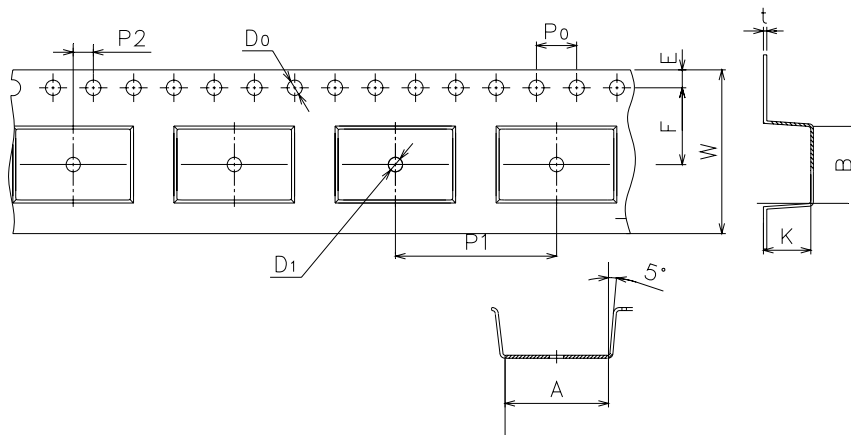

Dimension No.	A	B	Do	D1	E	F
Dimension (mm)	10.4±0.1	7.52±0.1	1.5±0.1	1.5+0.1/-0	1.75±0.1	7.5±0.1

Dimension No.	Po	P1	P2	t	W	K
Dimension (mm)	4.0±0.15	16.0±0.1	2.0±0.1	0.35±0.03	16.0±0.2	4.5±0.1



LIGHTING FOREVER

# 6 PIN DIP PHOTOTRANSISTOR PHOTOCOUPLER

## CNY17-X Series CNY17F-X Series

### Solder Reflow Temperature Profile

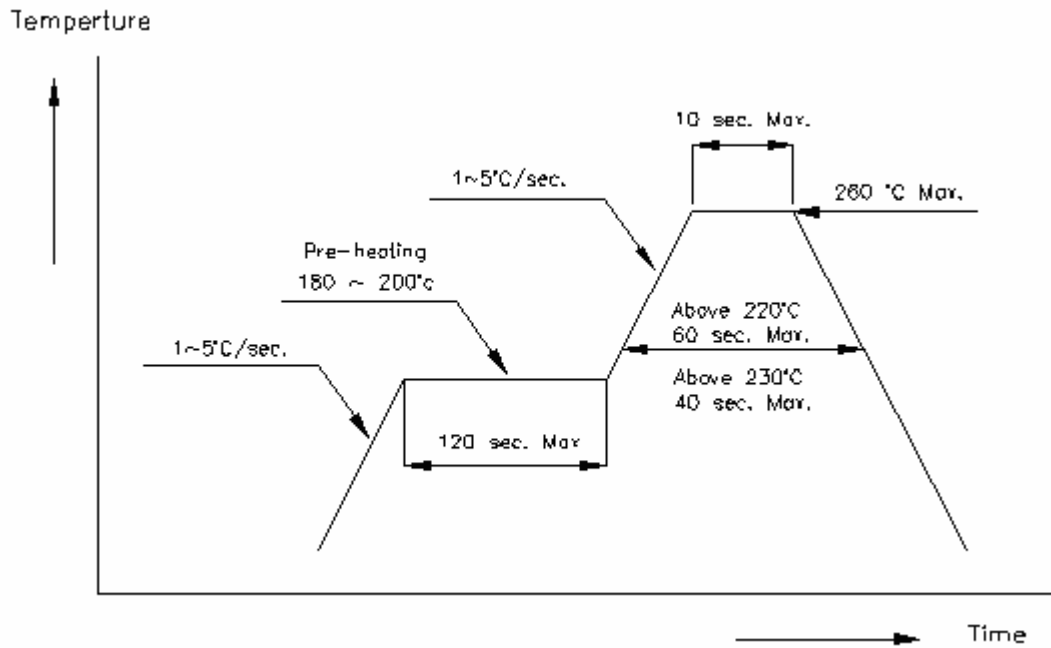



# 6 PIN DIP PHOTOTRANSISTOR PHOTOCOUPLER

**CNY17-X Series**  
**CNY17F-X Series**

---

## DISCLAIMER

1. Above specification may be changed without notice. EVERLIGHT will reserve authority on material change for above specification.
2. When using this product, please observe the absolute maximum ratings and the instructions for use outlined in these specification sheets. EVERLIGHT assumes no responsibility for any damage resulting from use of the product which does not comply with the absolute maximum ratings and the instructions included in these specification sheets.
3. These specification sheets include materials protected under copyright of EVERLIGHT corporation. Please don't reproduce or cause anyone to reproduce them without EVERLIGHT's consent.