

**ANALOG CLOCK IC WITH SNOOZE FUNCTION**
**■ GENERAL DESCRIPTION**

The NJU6304 is an analog clock IC driving a stepping motor with soft start alarm and snooze function.

It consists of a quartz crystal oscillator, frequency divider, output pulse generators, push-pull motor drivers, alarm with snooze function controller and alarm output.

The alarm with snooze function controller performs soft-start gradual-increase alarm sound repeated with a constant pre-fixed interval period until stopped.

The input and output of the quartz crystal oscillator are provided with oscillation capacitors. Consequently, only a quartz crystal is required as the external component.

The motor driving pulse width made by output pulse generators, alarm modulation pattern and alarm active level are all option.

**■ FEATURES**

- Soft Start Alarm Sound
- Snooze Function
- Low Operating Current -- 1uA typ.
- Oscillation Capacitor On-chip
- Operating Voltage -- 1.5V
- Package Outline -- DIP/DMP 8
- C-MOS Technology

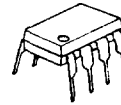
**■ PACKAGE OUTLINE**

NJU6304XD

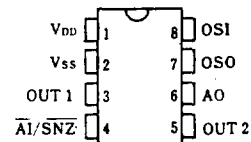

NJU6304XM

**■ PIN CONFIGURATION**

**■ LINE-UP**

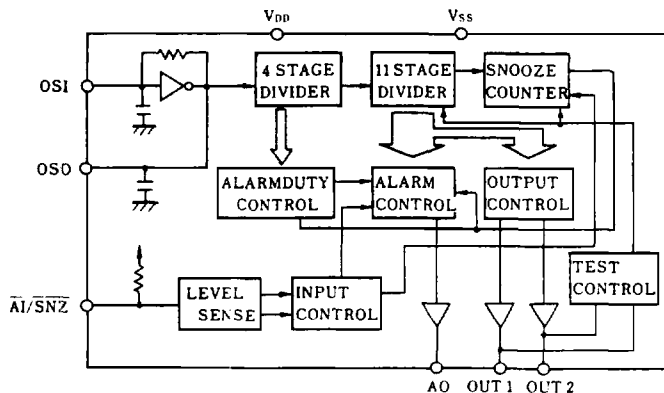
| Version | Motor Driving |        | Alarm Output |            |        | $\bar{A}I/SNZ$ | Int.Capacitor  |                |
|---------|---------------|--------|--------------|------------|--------|----------------|----------------|----------------|
|         | Pulse Width   | Active | Fundamental  | Modulation | Active |                | C <sub>i</sub> | C <sub>o</sub> |
| A       | 31.25ms       | H      | 2 kHz        | 8Hz+1Hz    | H      | AI             | 2pF            | 23pF           |

**■ BLOCK DIAGRAM**

**■ TERMINAL DESCRIPTION**

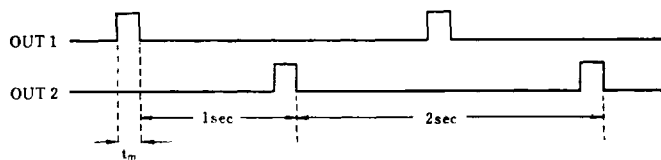
| NO. | SYMBOL          | F U N C T I O N   |
|-----|-----------------|---|
| 1   | V <sub>DD</sub> | +1.5V   |
| 2   | V <sub>SS</sub> | GND   |
| 3   | OUT1            | Stepping Motor Driving Terminal. Active "H"   |
| 4   | AT/SNZ          | Alarm/Snooze Input Terminal.<br>When this terminal level change from "H" to "L" during alarm ringing or in snooze period, the snooze function is restarted. |
| 5   | OUT2            | Stepping Motor Driving Terminal. Active "H"   |
| 6   | AO              | Alarm Output Terminal. Active "H"   |
| 7   | OSO             | Quartz Crystal Connecting Terminal. On-chip capacitance=30pF Max.<br>(Refer the Line-up table for actual capacitance value)                                 |
| 8   | OSI             | Quartz Crystal Connecting Terminal. On-chip capacitance=15pF Max.<br>(Refer the Line-up table for actual capacitance value)                                 |

**■ FUNCTIONAL DESCRIPTION**
**(1) Motor Driving Output**

**(2) Alarm Output Waveform**

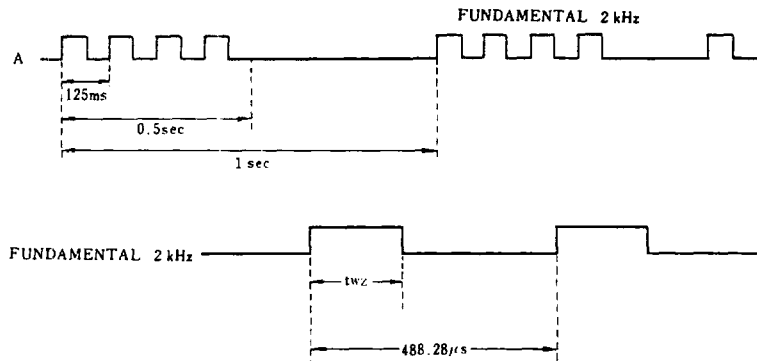
Alarm signal of the following pattern is output from the Alarm Output Terminal.  
(Pin No.6)



**(3) Alarm Duty**

|       |        |         |          |           |
|-------|--------|---------|----------|-----------|
| Alarm | 0~8sec | 8~16sec | 16~32sec | 32~128sec |
| twz   | 30.5us | 61.0us  | 122.1us  | 244.1us   |
| duty  | 6.25%  | 12.5%   | 25.0%    | 50.0%     |

**(4) Alarm Input/User Test**

When  $1/2V_{DD}$  level is input on pin No.4, AO output the continuous waveform for frequency adjustment shown below.

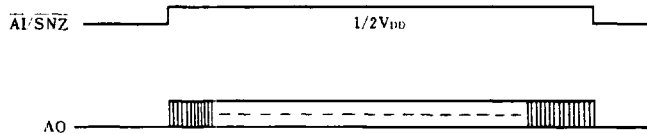
**(5)  $\overline{AI/SNZ}$  function**

When this terminal level change from "H" to "L" during alarm ringing or in snooze period, the snooze frequency is restarted. After 256sec of snooze period, the alarm sound output for 128sec.

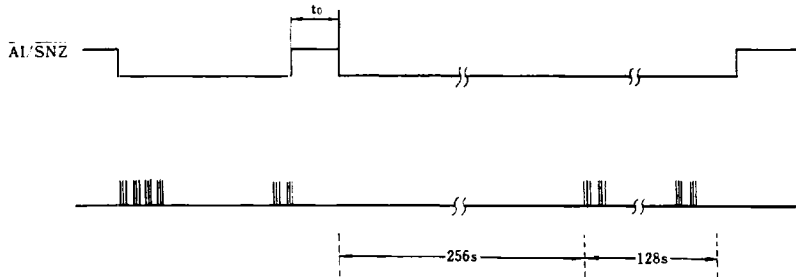

If the  $t_{to}$  input is over 8.0sec, the snooze is canceled and 4.0 to 8.0sec is unfixed(cancel or not cancel).

**(6) Snooze Speed Test**

When OUT1 and OUT2 level is "H",snooze time is shortened to 0.25sec.

**■ ABSOLUTE MAXIMUM RATINGS**

(  $T_a=25^{\circ}C$  )

| PARAMETER             | SYMBOL    | RATINGS                    | UNIT        |
|-----------------------|-----------|----------------------------|-------------|
| Supply Voltage        | $V_{DD}$  | - 0.3 ~ 7.0                | V           |
| Input Voltage         | $V_{IN}$  | - 0.3 ~ $V_{DD}+0.3$       | V           |
| Power Dissipation     | $P_D$     | ( DIP ) 250<br>( DMP ) 200 | mW          |
| Operating Temperature | $T_{opr}$ | - 20 ~ + 70                | $^{\circ}C$ |
| Storage Temperature   | $T_{stg}$ | - 40 ~ + 150               | $^{\circ}C$ |
| Soldering Temperature | $T_{SLD}$ | 260                        | $^{\circ}C$ |
| Soldering Time        | $t_{SLD}$ | 10                         | sec         |

**■ ELECTRICAL CHARACTERISTICS**

 (V<sub>DD</sub>-V<sub>SS</sub>=1.5V, T<sub>a</sub>=25°C)

| PARAMETER             | SYMBOL            | CONDITIONS   | MIN                    | TYP                  | MAX                    | UNIT     |
|-----------------------|-------------------|--|------------------------|----------------------|------------------------|----------|
| Operating Voltage     | V <sub>DD</sub>   |  | 1.1                    |                      | 2.0                    | V        |
| Operating Current     | I <sub>DD</sub>   | No Load  |                        | 1.0                  | 2.0                    | μA       |
| Motor Driving Current | I <sub>M</sub>    | V <sub>DD</sub> =1.2V, R <sub>L</sub> =200Ω              | 4.0                    |                      |                        | mA       |
| Alarm Output Current  | I <sub>OH</sub>   | V <sub>DD</sub> =1.2V, V <sub>OH</sub> =0.7V             | 0.3                    |                      |                        | mA       |
|                       | I <sub>OL</sub>   | V <sub>DD</sub> =1.2V, V <sub>OL</sub> =0.5V             | 0.3                    |                      |                        |          |
| Input Voltage         | V <sub>IH</sub>   | No.4 Terminal<br>( $\overline{AT}$ or $\overline{SNZ}$ ) | V <sub>DD</sub> -0.2   |                      | V <sub>DD</sub>        | V        |
|                       | V <sub>IL</sub>   |  | V <sub>SS</sub>        | V <sub>SS</sub> +0.2 |                        |          |
|                       | V <sub>TEST</sub> |  | 0.9*1/2V <sub>DD</sub> | 1/2V <sub>DD</sub>   | 1.1*1/2V <sub>DD</sub> |          |
| Input Resistance      | R <sub>IN</sub>   |  | 0.1                    | 0.5                  | 1.0                    | MΩ       |
| Oscillation Stability | Δf/f              |  |                        | 0.5                  | 1.0                    | ppm/0.1V |
| Oscillation Capacitor | C <sub>O</sub>    | f=100kHz   | -7%                    | Note                 | +7%                    | pF       |
|                       | C <sub>I</sub>    |  |                        |                      |                        |          |

Note) Typical value of on-chip capacitor is mentioned in Line-up table.