

Home Products Quick Quote My Parts List Site Map Contact Us



EQVA23 Series Oscillator

Voltage Controlled Quartz Crystal Clock Oscillators VCXO LVCMOS (CMOS) 3.3Vdc 6 Pad 3.2mm x 5.0mm Ceramic Surface Mount (SMD)



Revision A 01/09/2015

Electrical Specifications

Nominal Frequency	10.000MHz to 200.000MHz <i>Some frequencies within this range may not be available.</i>
Frequency Tolerance/Stability	Inclusive of all conditions: Calibration Tolerance (at 25°C), Frequency Stability over the Operating Temperature Range, Supply Voltage Change and Output Load Change ±50ppm Maximum
Operating Temperature Range	0°C to +70°C -20°C to +70°C -40°C to +85°C
Aging at 25°C	±2ppm Maximum First Year, ±10ppm/10 Years Maximum
Supply Voltage	3.3V _{DC} ±5%
Input Current	Click to Open Input Current Table
Output Voltage Logic High (V_{OH})	I _{OH} = -4mA 90% of V _{DD} Minimum
Output Voltage Logic Low (V_{OL})	I _{OL} = +4mA 10% of V _{DD} Maximum
Duty Cycle	Measured at 50% of Waveform 50 ±10(%) 50 ±5(%)
Rise Time/Fall Time	Measured at 10% to 90% of Waveform 3nSec Maximum
Load Drive Capability	15pF Maximum
Output Logic Type	CMOS
Absolute Pull Range	Inclusive of all conditions: Calibration Tolerance (at 25°C), Frequency Stability over the Operating Temperature Range, Supply Voltage Change, Output Load Change, Shock, Vibration, and 10 Year Aging over the Control Voltage (V _c) ±30ppm Minimum ±50ppm Minimum
Control Voltage	Test Condition for APR 0.3V _{DC} to 3.0V _{DC}
Control Voltage Range	0.0V _{DC} to V _{DD} +0.6V _{DC}
Linearity	5% Typical, 10% Maximum
Transfer Function	Positive Transfer Characteristic
Modulation Bandwidth	Measured at -3dB, V _c = 1.65V _{DC} 10kHz Minimum

Input Impedance	500kOhms Minimum
Input Leakage Current	10 μ A Maximum
Phase Noise	Click to Open Phase Noise Table
Output Control Function	Output Enable (OE)
Output Control Input Voltage Logic High (Vih)	90% of V _{DD} Minimum or No Connect to Enable Output
Output Control Input Voltage Logic Low (Vil)	10% of V _{DD} Maximum to Disable Output (High Impedance)
Output Enable Time	100nSec Maximum
Output Disable Time	50nSec Maximum
Output Enable Current	Without Load (Pin 2 = Ground) 18mA Maximum
RMS Phase Jitter	Click to Open RMS Phase Jitter Table
Period Jitter (Deterministic)	0.2pSec Typical
Period Jitter (Random)	2pSec Typical
Period Jitter (RMS)	3pSec Maximum
Period Jitter (pk-pk)	30pSec Maximum
Storage Temperature Range	-55°C to +125°C
Start Up Time	10mSec Maximum

Input Current

Unloaded

<i>Nominal Frequency Range</i>	<i>Input Current</i>
10MHz to 50MHz	20mA Maximum
50.000001MHz to 100MHz	25mA Maximum
100.000001MHz to 200MHz	30mA Maximum

Phase Noise

All Values are Typical

Nominal Frequency: 10MHz to 50MHz

<i>Offset</i>	<i>Phase Noise</i>
10Hz	-64dBc/Hz
100Hz	-96dBc/Hz
1kHz	-124dBc/Hz
10kHz	-131dBc/Hz
100kHz	-132dBc/Hz
1MHz	-149dBc/Hz
10MHz	-157dBc/Hz
20MHz	-159dBc/Hz

Nominal Frequency: 50.000001MHz to 100MHz

<i>Offset</i>	<i>Phase Noise</i>
10Hz	-58dBc/Hz
100Hz	-90dBc/Hz
1kHz	-118dBc/Hz
10kHz	-125dBc/Hz
100kHz	-126dBc/Hz
1MHz	-145dBc/Hz
10MHz	-155dBc/Hz
20MHz	-157dBc/Hz

Nominal Frequency: 100.000001MHz to 156.249999MHz

<i>Offset</i>	<i>Phase Noise</i>
10Hz	-57dBc/Hz
100Hz	-86dBc/Hz
1kHz	-114dBc/Hz
10kHz	-121dBc/Hz
100kHz	-122dBc/Hz
1MHz	-141dBc/Hz
10MHz	-151dBc/Hz
20MHz	-153dBc/Hz

Nominal Frequency: 156.25MHz to 200MHz

<i>Offset</i>	<i>Phase Noise</i>
10Hz	-58dBc/Hz
100Hz	-86dBc/Hz
1kHz	-110dBc/Hz
10kHz	-116dBc/Hz
100kHz	-117dBc/Hz
1MHz	-136dBc/Hz
10MHz	-146dBc/Hz
20MHz	-148dBc/Hz

RMS Phase Jitter

Fj=12kHz to 20MHz (Random)

<i>Nominal Frequency Range</i>	<i>RMS Phase Jitter</i>
10MHz to 50MHz	1.5pSec Maximum
50.000001MHz to 100MHz	1.4pSec Maximum
100.000001MHz to 200MHz	1.3pSec Maximum

Mechanical Dimensions

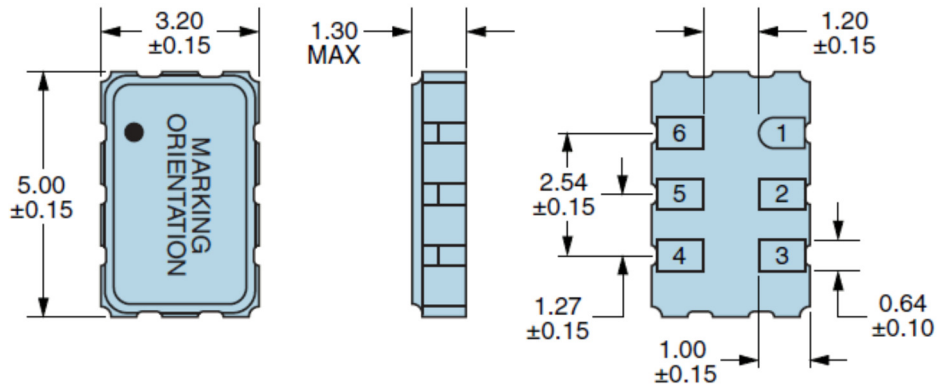

All Dimensions in Millimeters

Pin 1: Control Voltage

Pin 2: Output Enable (OE)

Pin 3: Case/Ground

Pin 4: Output

Pin 5: Do Not Connect

Pin 6: Supply Voltage

Marking Specifications

Line 1:

EXXXXXX

- E = Ecliptek Designator
- XXXXXX = Nominal Frequency in MHz (5 Digits + Decimal)

Line 2:

XXXXX

- XXXXX = Ecliptek Manufacturing Identifier

Environmental and Mechanical Specifications

ESD Susceptibility	MIL-STD-883, Method 3015, Class 1, HBM: 1500V
Fine Leak Test	MIL-STD-883, Method 1014, Condition A
Flammability	UL94-V0
Gross Leak Test	MIL-STD-883, Method 1014, Condition C
Mechanical Shock	MIL-STD-883, Method 2002, Condition B
Moisture Resistance	MIL-STD-883, Method 1004
Moisture Sensitivity	J-STD-020, MSL 1
Resistance to Soldering Heat	MIL-STD-202, Method 210, Condition K
Resistance to Solvents	MIL-STD-202, Method 215
Solderability	MIL-STD-883, Method 2003
Temperature Cycling	MIL-STD-883, Method 1010, Condition B
Vibration	MIL-STD-883, Method 2007, Condition A
Thermal Resistance (θ_{JA})	42°C/W (degrees Celsius per Watt)
Thermal Resistance (θ_{JC})	15°C/W (degrees Celsius per Watt)

Tape & Reel Dimensions

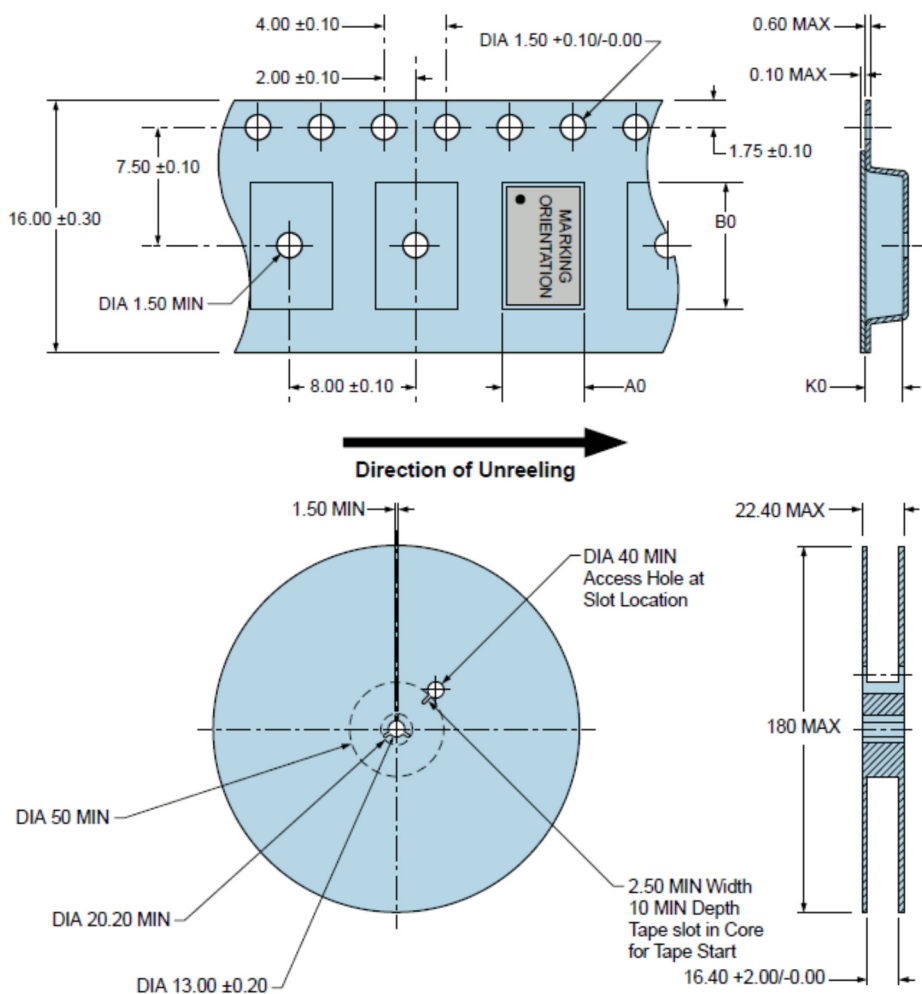

1000 pieces per reel
 Compliant to EIA-481
 All Dimensions in Millimeters

Test Circuit for CMOS Output

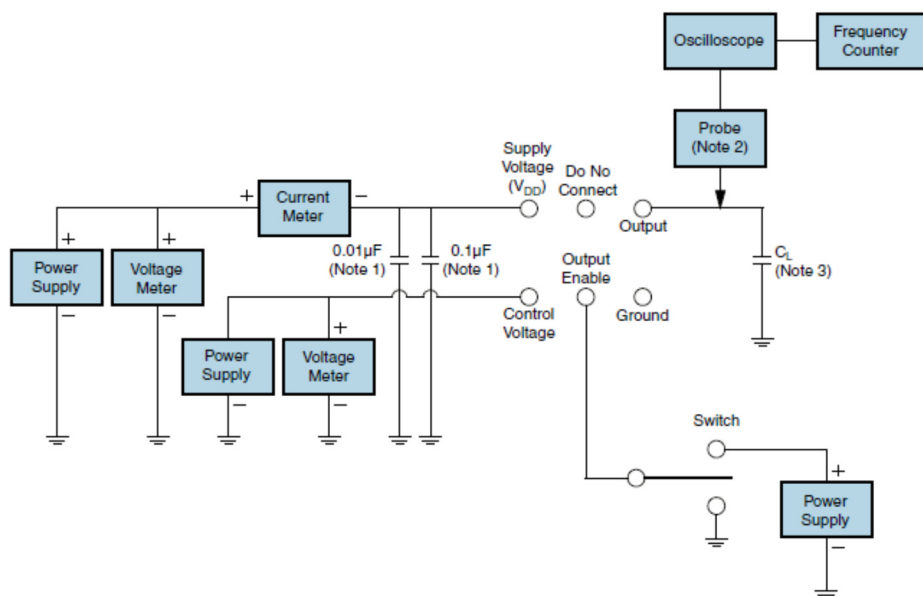

Note 1: An external $0.01\mu\text{F}$ ceramic bypass capacitor in parallel with a $0.1\mu\text{F}$ high frequency ceramic bypass capacitor close (less than 2mm) to the package ground and supply voltage pin is required.

Note 2: A low capacitance ($<12\text{pF}$), 10X attenuation factor, high impedance ($>10\text{Mohms}$), and high bandwidth ($>300\text{MHz}$) passive probe is recommended.

Note 3: Capacitance value C_L includes sum of all probe and fixture capacitance.

Recommended Solder Pad Dimensions

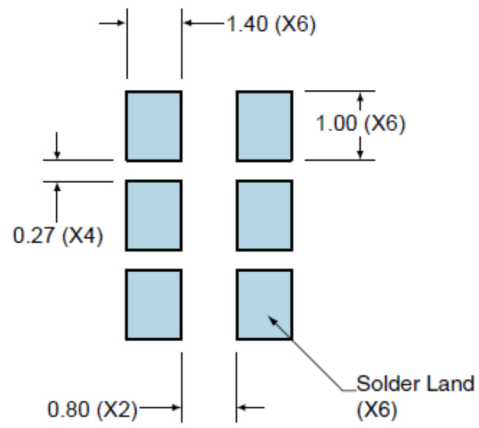

Tolerances = ± 0.1
All Dimensions in Millimeters

Solder Reflow Profile

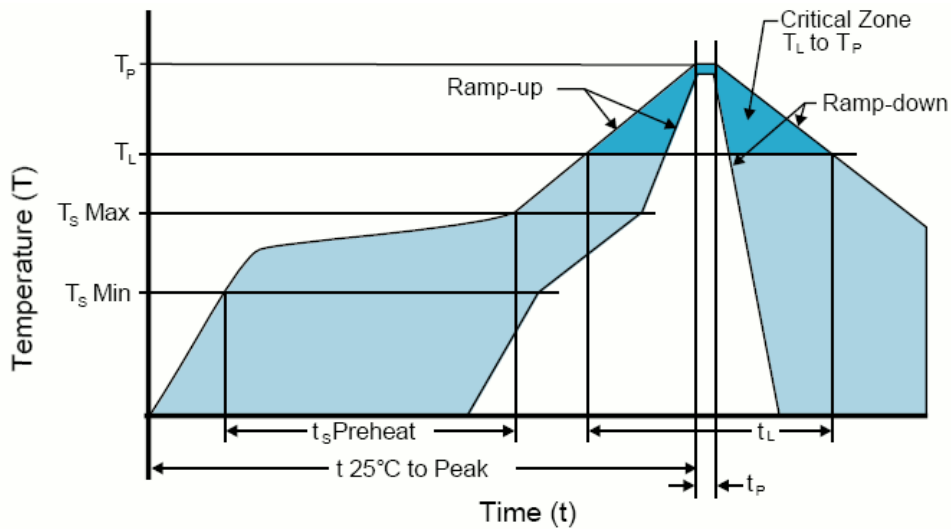

High Temperature Infrared/Convection

Note: Temperatures shown are applied to body of device.

T_S MAX to T_L (Ramp-up Rate)	3°C/Second Maximum
Preheat	
- Temperature Minimum (T _S MIN)	150°C
- Temperature Typical (T _S TYP)	175°C
- Temperature Maximum (T _S MAX)	200°C
- Time (t _s)	60 - 180 Seconds
Ramp-up Rate (T_L to T_P)	3°C/Second Maximum
Time Maintained Above:	
- Temperature (T _L)	217°C
- Time (t _L)	60 - 150 Seconds
Peak Temperature (T_P)	260°C Maximum for 10 Seconds Maximum
Target Peak Temperature (T_P Target)	250°C +0/-5°C
Time within 5°C of actual peak (t_p)	20 - 40 Seconds
Ramp-down Rate	6°C/Second Maximum
Time 25°C to Peak Temperature (t)	8 Minutes Maximum
Moisture Sensitivity Level	Level 1

Low Temperature Infrared/Convection 240°C

Note: Temperatures shown are applied to body of device.

T_S MAX to T_L (Ramp-up Rate)	5°C/Second Maximum
Preheat	
- Temperature Minimum (T _S MIN)	N/A
- Temperature Typical (T _S TYP)	150°C
- Temperature Maximum (T _S MAX)	N/A
- Time (t _S)	60 - 120 Seconds
Ramp-up Rate (T_L to T_P)	5°C/Second Maximum
Time Maintained Above:	
- Temperature (T _L)	150°C
- Time (t _L)	200 Seconds Maximum
Peak Temperature (T_P)	240°C Maximum
Target Peak Temperature (T_P Target)	240°C Maximum 2 Times / 230°C Maximum 1 Time
Time within 5°C of actual peak (t_p)	10 Seconds Maximum 2 Times / 80 Seconds Maximum 1 Time
Ramp-down Rate	5°C/Second Maximum
Time 25°C to Peak Temperature (t)	N/A
Moisture Sensitivity Level	Level 1

High Temperature Manual Soldering

Note: Temperatures listed are applied to body of device.
260°C Maximum for 5 Seconds Maximum, 2 times Maximum.

Low Temperature Manual Soldering

Note: Temperatures listed are applied to body of device.
185°C Maximum for 10 Seconds Maximum, 2 times Maximum.

1 - Build A Part Number

Select the parameters that meet your requirements and then click Next

Frequency in Megahertz (10 to 200):
Some frequencies within this range may not be available

Operating Temperature Range:

Absolute Pull Range:







Duty Cycle:

Packaging Options:

 Next

2 - Next Page

Access these Part Number specific resources and tools

-  [P/N Specific Data Sheet](#)
-  [Automated Quick Quote](#)
-  [Request Sample](#)
-  [Download IPC-1752](#)
-  [My Parts List ?](#)
-  [My Part Number ?](#)

Part Numbering Guide

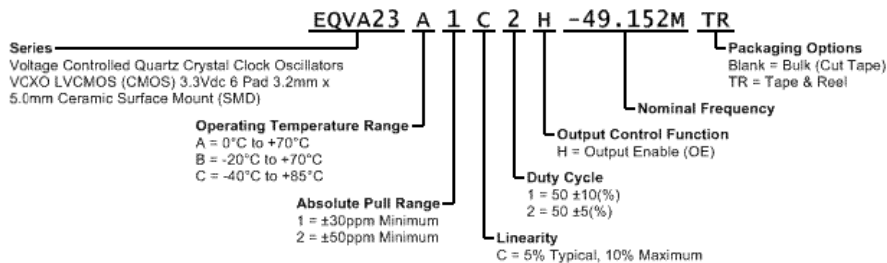

TOOLS

- [Quick Quote](#)
- [SmartSearch](#)
- [Compliance Documents](#)
- [Chipset Cross Reference](#)
- [Competitor Cross Reference](#)

PRODUCT

- [Crystals](#)
- [Oscillators](#)
- [Part Search](#)
- [REACH Resources](#)
- [RoHS Resources](#)
- [End of Life](#)

ECLIPTEK

- [Authorized Distributors](#)
- [Contact](#)
- [About](#)
- [News](#)
- [Our Quality](#)
- [ISO9001](#)
- [Feedback](#)

TERMS

- [Privacy Policy](#)
- [Terms of Sale](#)
- [Legal](#)