

Digital Controlled Variable Gain Amplifier

DVGA2-33A+

50Ω 0.05 to 3 GHz
31.5 dB, 0.5 dB Step, 6 Bit Serial Control

The Big Deal

- Integrated Amplifier and Digital Attenuator
- 19 dB Gain / 31.5 dB Gain Control
- Flat frequency response, ± 0.7 dB (700-2100 MHz)

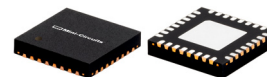

CASE STYLE: DG1677

Product Overview

The DVGA2-33A+ is a 50Ω RF Digital Variable Gain Amplifier that offers an attenuation of 31.5 dB in 0.5 dB steps using a 6-bit serial interface attenuator and 19dB gain using a InGap HBT amplifier. Step attenuator used in DVGA2-33A+ is produced using a unique combination of CMOS process on silicon, offering the performance of GaAs, with the advantages of conventional CMOS devices.

Key Features

Feature	Advantages
31.5 dB attenuation in 0.5 dB step size	Combining medium gain and a wide range of gain control makes the DVGA2-33A+ an ideal building block for any RF chain where level setting control is required in a small space.
Flat frequency response, ± 0.7 over 700-2100 MHz	No need for external components to flatten gain.
Medium Gain, 19 dB	Incorporating multiple stages of amplification, the DVGA2-33A+ provides medium gain over a wideband reducing cost and PCB board space.
Good IP3, +30 dBm at 1.0 GHz	Use in receivers and transmitters giving the users advantage in instantaneous spur free dynamic range over wide bandwidths.
Output Power, +16.4 dBm at 1.0 GHz	The DVGA2-33A+ maintains consistent output power capability over the full attenuation range and operating temperature range making it ideal to be used in remote applications such as LNB's as the L Band driver stage.
Attenuation Step size, 0.5 dB, accuracy 0.1 to 0.7 dB typ. Total attenuation, 31.5 dB	Enables precise control of gain in 0.5 dB steps up to 31.5 dB.
MCLP Package	Low Inductance, repeatable transitions, excellent thermal pad.
PCB area reduction	The DVGA2-33A+ combines multiple functions common to TX/RX architectures into a single 5x5mm package
Flexibility in the application block diagram	The DVGA2-33A+ provides access to the internal circuit through external jumper (see simplified schematic) enables designers flexibility to incorporate a wide range of additional circuits.

Digital Controlled Variable Gain Amplifier

50Ω 50 - 3000 MHz

19 dB Gain, 0.5 dB Step, 31.5 dB Attenuation,
6 Bit Serial Control

Product Features

- 31.5 dB Gain control 0.5dB step size
- Gain, 19 dB nominal at 0dB attenuation and 1 GHz
- Useable to 4 GHz
- Serial control interface
- Small size 5.0 x 5.0 mm

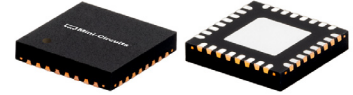

Generic photo used for illustration purposes only

CASE STYLE: DG1677

DVGA2-33A+

+RoHS Compliant

The +Suffix identifies RoHS Compliance. See our web site for RoHS Compliance methodologies and qualifications

Typical Applications

- Base Station Infrastructure
- GPS
- LTE
- WCDMA

General Description

The DVGA2-33A+ is a 50Ω RF Digital Variable Gain Amplifier that offers an attenuation of 31.5 dB in 0.5 dB steps using a 6-bit serial interface attenuator and 19dB gain using a InGaP HBT amplifier. Step attenuator used in DVGA2-33A+ is produced using a unique combination of CMOS process on silicon, offering the performance of GaAs, with the advantages of conventional CMOS devices.

Simplified Schematic

(Refer to Table 1 for Pad description)

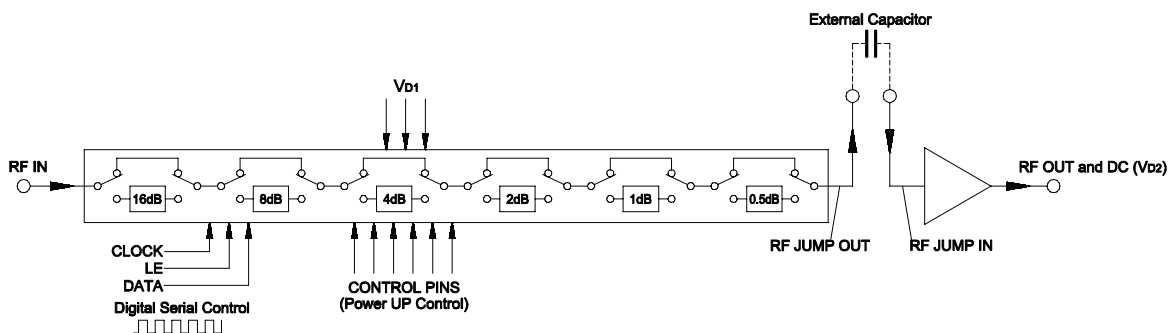

RF Electrical Specifications⁽¹⁾ at 25°C, 50Ω With V_{D1}=+3.0V, V_{D2}=+5V

Parameter	Condition (GHz)	Min.	Typ.	Max.	Units
Frequency Range		0.05		3.0	GHz
Gain (at 0 dB attenuation)	0.05	—	20.5	—	dB
	1.0	—	19.3	—	
	2.0	16.3	18.1	20.0	
	3.0	—	16.1	—	
Input Return Loss (all states)	0.05	—	13.2	—	dB
	1.0	—	12.8	—	
	2.0	—	12.7	—	
	3.0	—	10.9	—	
Output Return Loss (all states)	0.05	—	16.6	—	dB
	1.0	—	13.8	—	
	2.0	—	15.1	—	
	3.0	—	10.2	—	
Output Power @ 1 dB compression (all states)	0.05	—	16.5	—	dBm
	1.0	—	16.4	—	
	2.0	—	18.0	—	
	3.0	—	16.1	—	
Output IP3 (all states)	0.05	—	31.7	—	dBm
	1.0	—	30.1	—	
	2.0	—	31.3	—	
	3.0	—	29.0	—	
Noise Figure (at 0 dB attenuation)	0.05	—	4.8	—	dB
	1.0	—	5.1	—	
	2.0	—	5.3	—	
	3.0	—	5.4	—	
Accuracy @ 0.5 dB Attenuation Setting	0.05 - 1.0	—	0.02	0.12	dB
	1.0 - 3.0	—	0.11	0.23	
Accuracy @ 1 dB Attenuation Setting	0.05 - 1.0	—	0.02	0.13	dB
	1.0 - 3.0	—	0.16	0.3	
Accuracy @ 2 dB Attenuation Setting	0.05 - 1.0	—	0.03	0.16	dB
	1.0 - 3.0	—	0.21	0.6	
Accuracy @ 4 dB Attenuation Setting	0.05 - 1.0	—	0.04	0.3	dB
	1.0 - 3.0	—	0.30	0.7	
Accuracy @ 8 dB Attenuation Setting	0.05 - 1.0	—	0.10	0.4	dB
	1.0 - 3.0	—	0.57	0.7	
Accuracy @ 16 dB Attenuation Setting	0.05 - 1.0	—	0.17	0.6	dB
	1.0 - 3.0	—	0.73	1.1	
Thermal Resistance (Amplifier) ²		—	91	—	°C/W

1. Measured in Mini-Circuits characterization test board TB-674A+. See characterization Test Circuit (Fig. 2)

2. Junction to ground paddle

Attenuation Switching Specifications

Parameter	Min.	Typ.	Max.	Units
Switching Speed, 50% Control to 0.5dB of Attenuation Value	—	1.0	—	μSec
Switching Rep Rate	—	—	25	KHz

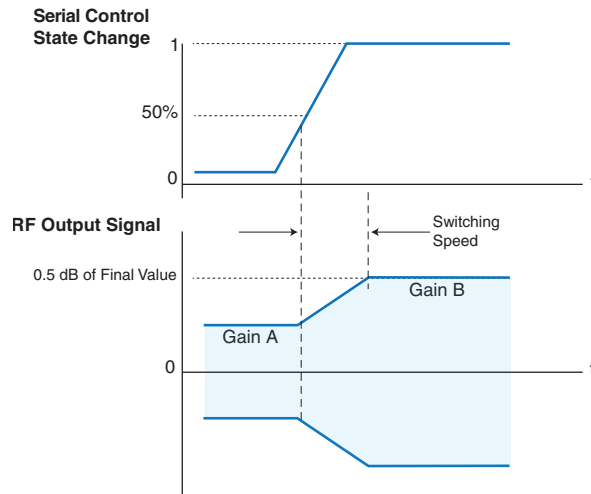

DC Electrical Specifications

Parameter	Min.	Typ.	Max.	Units
Supply Voltage, V_{D1}	2.7	3.0	3.3	V
V_{D2}	4.75	5.0	5.25	V
Supply Current, I_{D1}	—	—	200	μA
I_{D2}	—	69	78	mA
Control Input Low	-0.3	—	0.6	V
Control Input High	1.17	—	3.6	V
Control Current*	—	—	20	μA

*Except 30 μA typ. for C0.5, C16

Absolute Maximum Ratings

Parameter	Ratings
Operating Temperature (ground pad)	-40°C to 85°C
Storage Temperature	-65°C to 150°C
V_{D1}	-0.3V Min., 5.5V Max.
V_{D2}	5.7V
Voltage on any control input	-0.3V Min., $V_{D1}+0.3V$ Max.
Input Power	+13dBm

Permanent damage may occur if any of these limits are exceeded.

Table 1. Pad Description

Pin Number	Function	Description
1	N/C	Not Connected
2	RF IN	RF Input Port (Note 1)
3	N/C	Not Connected
4	N/C	Not Connected
5	DATA	Serial Interface Data Input (Note 3)
6	CLOCK	Serial Interface Clock Input
7	LE	Latch Enable Input (Note 2)
8	N/C	No Connection
9	N/C	Not Connected (Note 6)
10	N/C	Not Connected (Note 6)
11	V _{D1}	V _{D1} Power Supply Input
12	GND	Ground
13	V _{D1}	V _{D1} Power Supply Input
14	N/C	Not Connected
15	N/C	Not Connected
16	N/C	Not Connected
17	RF OUT & V _{D2}	RF output and V _{D2} on same pad (external Bias Tee) (Note 1,6)
18	N/C	Not Connected
19	N/C	Not Connected
20	N/C	Not Connected
21	N/C	Not Connected
22	RF JUMP IN	Interstage RF Jumper Input (Note 1)
23	RF JUMP OUT	Interstage RF Jumper Output (Note 1)
24	N/C	Not Connected
25	N/C	Not Connected
26	C8	Power Up Control for 8dB Att. Bit (Note 4)
27	C4	Power Up Control for 4dB Att. Bit (Note 4)
28	C2	Power Up Control for 2dB Att. Bit (Note 4)
29	C1	Power Up Control for 1dB Att. Bit (Note 4)
30	C0.5	Power Up Control for 0.5dB Att. Bit (Note 4)
31	C16	Power Up Control for 16dB Att. Bit (Note 4)
32	N/C	Not Connected
PADDLE	GND	Ground (Note 5)

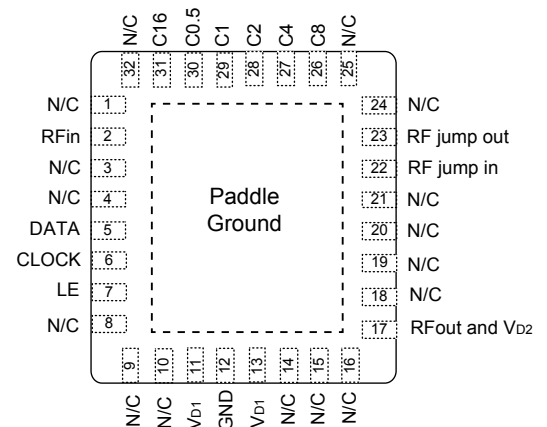

Notes:

1. All RF input and output ports shall be AC coupled with external blocking capacitor.
2. Latch Enable (LE) has an internal 2MΩ pull-up resistor to V_{D1}.
3. Place a 10KΩ resistor in series, as close to pin as possible to avoid freq. resonance (see layout drawing PL-371).
4. Refer to Power-up Control Settings.
5. The exposed solder pad on the bottom of the package (See Pin Configuration) must be grounded for proper device operation
6. See application and characterization test circuit Fig. 2 and layout drawing PL-371.

Application and Characterization Test Circuit

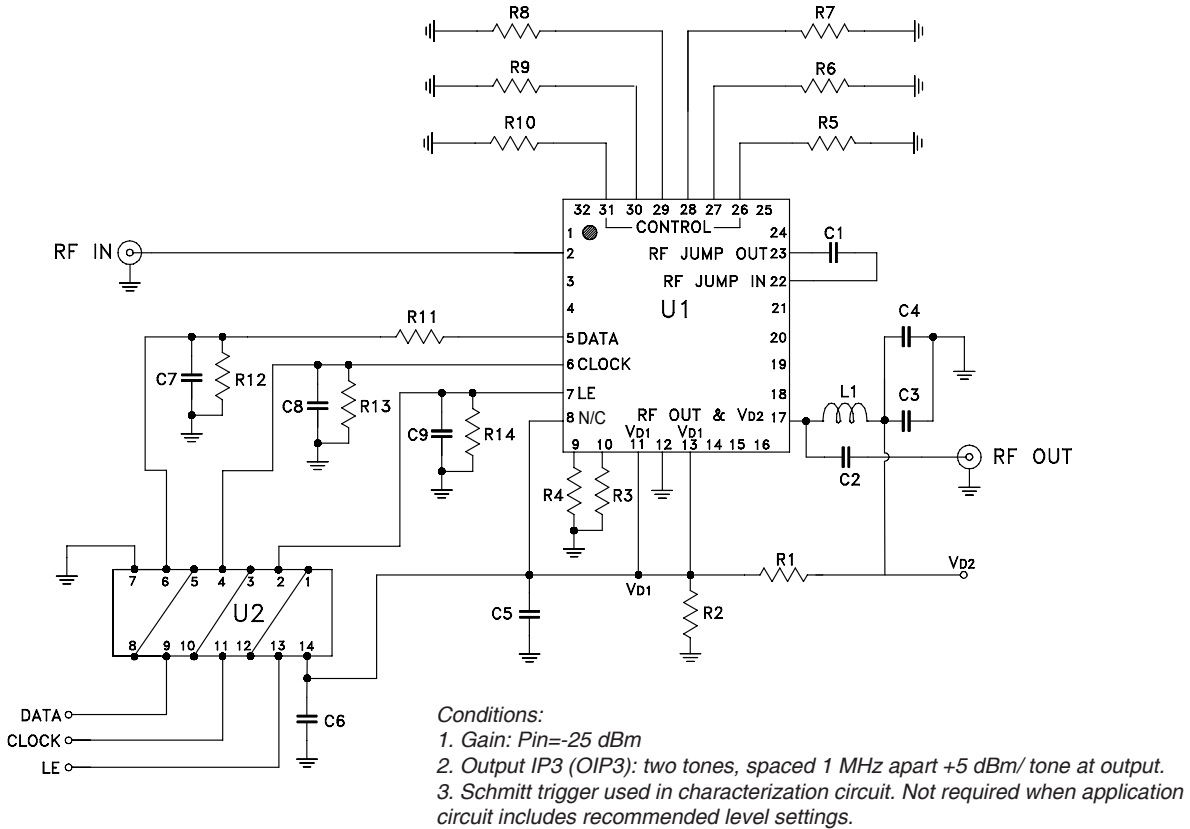

Figure 2. Schematic of Test Circuit used for Characterization. (DUT soldered on Mini-Circuits Characterization Test Board TB-674A+). Gain, output power at 1 dB compression (P1dB) Output IP3 (OIP3), Noise Figure are measured using Agilent’s N5242A PNA-X Microwave Network Analyzer.

Bill of Materials

Ref. Des.	Value / Description	Case Style, Size
C1	1000pF	0402
C2	1000pF	0805
C3	1μF	0805
C4	100pF	0402
C5, C7, C8, C9	100pF	0603
C6	0.47μF	0805
L1	390nH	0402
R1	475Ω	0603
R2	681Ω	0603
R3 - R14	10kΩ	0603
U2	HEX Inverter Trigger Fairchild P/N MM74HC14M	
U1	DVGA2-33A+	

Note: To operate down to 10 MHz, change:
 1) C1 & C2 to 2400 pF and
 2) L1 to 3.9 μH
 3) C1, C2, L1 should be free of resonance over usage BW

Product Marking

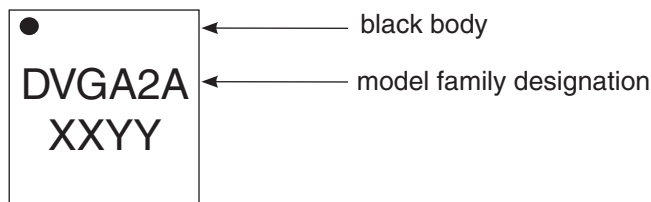

Simplified Schematic

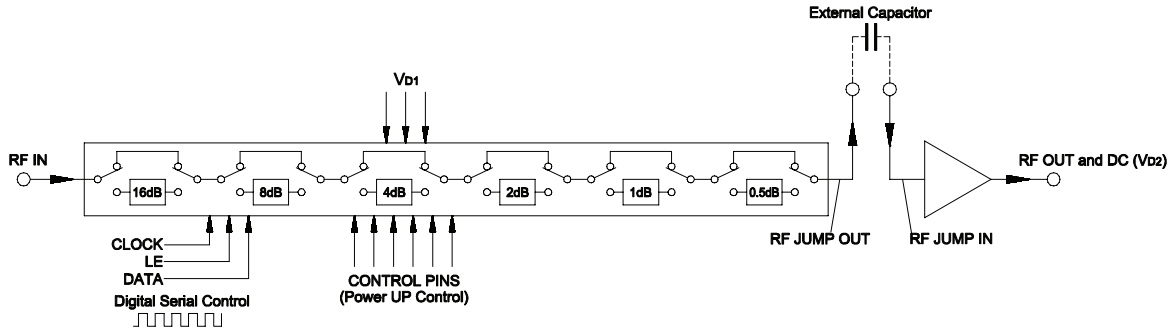

Figure 3. The DVGA2-33A+ Serial interface consists of 6 control bits that select the desired attenuation state, as shown in Table 2 Truth Table.

Table 2. Truth Table

Attenuation State	C16	C8	C4	C2	C1	C0.5
Reference	0	0	0	0	0	0
0.5 (dB)	0	0	0	0	0	1
1 (dB)	0	0	0	0	1	0
2 (dB)	0	0	0	1	0	0
4 (dB)	0	0	1	0	0	0
8 (dB)	0	1	0	0	0	0
16 (dB)	1	0	0	0	0	0
31.5 (dB)	1	1	1	1	1	1

Note: Not all 64 possible combinations of C0.5 - C16 are shown in table

The serial interface is a 6-bit serial in, parallel-out shift register buffered by a transparent latch. It is controlled by three CMOS-compatible signals: Data, Clock, and Latch Enable (LE). The Data and Clock inputs allow data to be serially entered into the shift register, a process that is independent of the state of the LE input. The LE input controls the latch. When LE is HIGH, the latch is transparent and the contents of the serial shift register control the attenuator. When LE is brought LOW, data in the shift register is latched. The shift register should be loaded while LE is held LOW to prevent the attenuator value from changing as data is entered. The LE input should then be toggled HIGH and brought LOW again, latching the new data. The timing for this operation is defined by Figure 4 (Serial Interface Timing Diagram) and Table 3 (Serial Interface AC Characteristics).

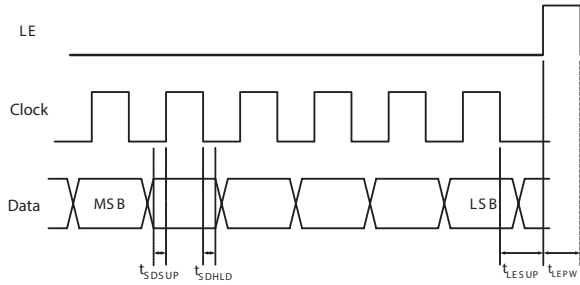

Figure 4. Serial Interface Timing Diagram

Table 3. Serial Interface AC Characteristics (V_{D1}=3V)

Symbol	Parameter	Min.	Max.	Units
f_{clk}	Serial data clock frequency (Note 1)		10	MHz
t_{clkH}	Serial clock HIGH time	30		ns
t_{clkL}	Serial clock LOW time	30		ns
t_{LESUP}	LE set-up time after last clock falling edge	10		ns
t_{LEPW}	LE minimum pulse width	30		ns
t_{SDSUP}	Serial data set-up time before clock rising edge	10		ns
t_{SDHLD}	Serial data hold time after clock falling edge	10		ns

Note 1. f_{clk} verified during the functional pattern test. Serial programming sections of the functional pattern are clocked at 10MHz to verify f_{clk} specification.

The DVGA2-33A+, uses a common 6-bit serial, as shown in Table 4: 6-Bit attenuator Serial Programming Register Map. The first bit, the MSB, corresponds to the 16-dB Step and the last bit, the LSB, corresponds to the 0.5dB step.

B5	B4	B3	B2	B1	B0
C16	C8	C4	C2	C1	C0.5

↑
MSB
(first in)

↑
LSB
(last in)

Power-up Control Settings

The DVGA2-33A+ always assumes a specifiable attenuation setting on power-up, allowing a known attenuation state to be established before an initial serial control word is provided. When the attenuator powers up, the six control bits are set to whatever data is present on the six control inputs (C0.5 to C16). This allows any one of the 64 attenuation settings to be specified as the power-up state.

Additional Detailed Technical Information	
<i>additional information is available on our dash board. To access this information click here</i>	
Performance Data	Data Table
	Swept Graphs
	S-Parameter (S2P Files) Data Set (.zip file)
Case Style	DG1677 Plastic package, exposed paddle, lead finish: Ni/Pd/Au
Tape & Reel Standard quantities available on reel	F68 7" reels with 20,50,100,200, 500 or 1K devices
Suggested Layout for PCB Design	PL-371
Evaluation Board	TB-674A+
Environmental Ratings	ENV66

ESD Rating

Human Body Model (HBM): Class 1A (250 to <500V) in accordance with ANSI/ESD STM 5.1 - 2001

Machine Model (MM): Class M1 (100V) in accordance with ANSI/ESD STM5.2-1999

MSL Rating

Moisture Sensitivity: MSL1 in accordance with IPC/JEDEC J-STD-020D

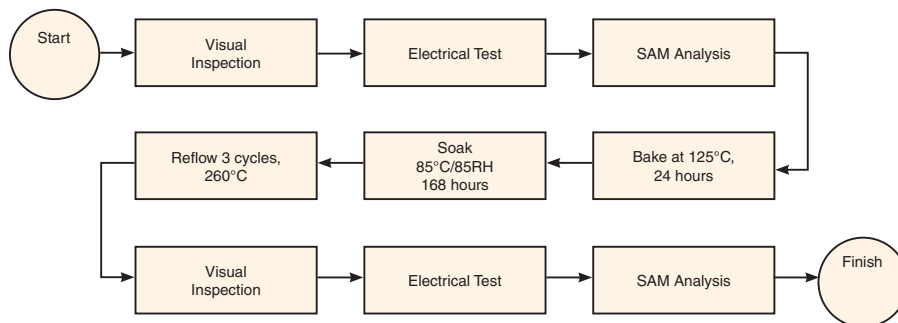

Additional Notes

- A. Performance and quality attributes and conditions not expressly stated in this specification document are intended to be excluded and do not form a part of this specification document.
- B. Electrical specifications and performance data contained in this specification document are based on Mini-Circuit's applicable established test performance criteria and measurement instructions.
- C. The parts covered by this specification document are subject to Mini-Circuits standard limited warranty and terms and conditions (collectively, "Standard Terms"); Purchasers of this part are entitled to the rights and benefits contained therein. For a full statement of the Standard Terms and the exclusive rights and remedies thereunder, please visit Mini-Circuits' website at www.minicircuits.com/MCLStore/terms.jsp

Digital Variable Gain Amplifier

DVGA2-33A+

Typical Performance Data

TEST CONDITIONS: Vd1 = +3V, Vd2 = +5V @ Temperature = +25degC

FREQ	GAIN @ 0dB Step	STEP ATTENUATION @							Output IP3 @ 0dB Step	Pout at 1dB Comp @ 0dB Step	Noise Figure @ 0dB Step
		0.5 dB	1.0 dB	2 dB	4 dB	8 dB	16 dB	31.5 dB			
(MHz)	(dB)	(dB)	(dB)	(dB)	(dB)	(dB)	(dB)	(dB)	(dBm)	(dBm)	(dB)
50	20.50	0.52	1.02	2.01	4.01	7.96	15.93	31.36	31.70	16.55	4.75
60	20.37	0.52	1.02	2.00	3.99	7.94	15.92	31.33	31.98	16.73	5.15
70	20.28	0.52	1.02	1.99	3.98	7.93	15.90	31.32	32.17	17.03	4.94
80	20.22	0.52	1.02	1.99	3.97	7.92	15.90	31.30	31.80	16.99	4.79
90	20.17	0.52	1.02	1.99	3.97	7.92	15.89	31.29	31.66	16.90	4.67
100	20.14	0.52	1.02	1.98	3.96	7.91	15.89	31.29	31.96	17.26	4.73
200	19.96	0.52	1.02	1.98	3.96	7.91	15.88	31.27	31.91	17.13	4.71
300	19.87	0.52	1.01	1.99	3.96	7.91	15.87	31.27	32.41	17.23	4.74
400	19.79	0.52	1.02	2.00	3.98	7.92	15.87	31.28	32.96	17.33	4.79
500	19.68	0.52	1.02	2.01	3.99	7.93	15.87	31.27	31.24	16.66	4.84
600	19.60	0.52	1.01	2.01	3.99	7.93	15.86	31.25	31.78	16.95	4.98
700	19.48	0.52	1.01	2.02	4.00	7.93	15.85	31.24	31.53	16.85	5.01
800	19.36	0.52	1.01	2.02	4.00	7.94	15.85	31.23	31.60	16.90	5.03
900	19.33	0.52	1.01	2.02	4.00	7.93	15.84	31.22	31.55	16.96	5.01
1000	19.27	0.52	1.01	2.03	4.00	7.93	15.83	31.18	30.08	16.41	5.08
1100	19.21	0.52	1.01	2.03	4.00	7.94	15.84	31.17	30.91	16.74	5.12
1200	19.13	0.52	1.01	2.02	3.99	7.93	15.83	31.15	31.12	16.79	5.16
1300	19.06	0.52	1.01	2.02	3.99	7.94	15.85	31.13	31.40	17.27	5.22
1400	18.97	0.52	1.02	2.02	3.99	7.94	15.86	31.12	31.13	17.26	5.27
1500	18.85	0.52	1.01	2.01	3.97	7.93	15.85	31.09	31.18	17.28	5.32
1600	18.74	0.52	1.02	2.01	3.97	7.93	15.86	31.07	31.62	17.62	5.37
1700	18.57	0.53	1.03	2.00	3.97	7.94	15.89	31.08	31.31	17.42	5.34
1800	18.50	0.53	1.04	2.00	3.97	7.95	15.91	31.08	31.85	17.90	5.30
1900	18.33	0.54	1.04	2.00	3.97	7.96	15.94	31.10	31.58	17.94	5.32
2000	18.14	0.54	1.05	1.99	3.96	7.96	15.95	31.10	31.35	18.03	5.35
2200	17.74	0.55	1.06	2.00	3.98	8.01	16.03	31.16	30.80	17.75	5.34
2400	17.32	0.56	1.08	2.03	4.02	8.09	16.16	31.27	30.01	16.97	5.32
2600	16.63	0.57	1.11	2.08	4.10	8.23	16.33	31.39	29.53	16.49	5.32
2800	16.53	0.59	1.13	2.14	4.19	8.39	16.53	31.49	29.33	16.39	5.35
3000	16.14	0.61	1.16	2.21	4.30	8.57	16.73	31.52	28.97	16.09	5.35



P.O. Box 350166, Brooklyn, New York 11235-0003 (718) 934-4500 • Fax (718) 332-4661 For detailed performance specs & shopping online see Mini-Circuits web site www.minicircuits.com **DVGA2-33A+**



The Design Engineers Search Engine Provides ACTUAL Data Instantly From MINI-CIRCUITS At: www.minicircuits.com

IF/RF MICROWAVE COMPONENTS

REV. OR

6/7/2016

Page 1 of 9

Digital Variable Gain Amplifier

DVGA2-33A+

Typical Performance Data

TEST CONDITIONS: Vd1 = +3V, Vd2 = +5V @ Temperature = -40degC

FREQ	GAIN @ 0dB Step	STEP ATTENUATION @							Output IP3 @ 0dB Step	Pout at 1dB Comp @ 0dB Step	Noise Figure @ 0dB Step
		0.5 dB	1.0 dB	2 dB	4 dB	8 dB	16 dB	31.5 dB			
(MHz)	(dB)	(dB)	(dB)	(dB)	(dB)	(dB)	(dB)	(dB)	(dBm)	(dBm)	(dB)
50	20.86	0.54	1.05	2.05	4.07	8.09	16.03	31.60	32.22	16.41	4.11
60	20.73	0.54	1.05	2.04	4.05	8.06	16.01	31.56	32.06	16.58	4.14
70	20.63	0.54	1.05	2.03	4.03	8.05	15.99	31.54	32.43	16.86	3.85
80	20.57	0.53	1.04	2.02	4.03	8.04	15.98	31.53	32.46	16.81	3.99
90	20.52	0.53	1.04	2.02	4.02	8.03	15.97	31.52	31.89	16.72	3.87
100	20.49	0.53	1.04	2.02	4.02	8.03	15.97	31.50	32.28	17.08	4.16
200	20.33	0.53	1.04	2.02	4.01	8.02	15.96	31.50	32.34	16.92	3.89
300	20.25	0.53	1.04	2.02	4.01	8.02	15.95	31.48	32.57	17.12	3.96
400	20.19	0.54	1.05	2.03	4.02	8.03	15.96	31.48	33.57	17.32	3.95
500	20.10	0.54	1.05	2.04	4.04	8.04	15.96	31.48	31.71	16.60	3.94
600	20.03	0.54	1.05	2.05	4.05	8.06	15.96	31.47	32.25	16.95	4.04
700	19.93	0.54	1.05	2.06	4.06	8.06	15.96	31.47	32.20	16.89	4.09
800	19.79	0.54	1.04	2.06	4.07	8.07	15.96	31.47	32.34	16.95	4.16
900	19.80	0.54	1.05	2.07	4.07	8.08	15.96	31.45	32.31	17.05	4.13
1000	19.75	0.54	1.04	2.07	4.08	8.08	15.96	31.42	30.79	16.48	4.15
1100	19.70	0.54	1.05	2.08	4.08	8.10	15.98	31.41	31.54	16.79	4.18
1200	19.63	0.54	1.05	2.08	4.08	8.10	15.97	31.39	31.55	16.84	4.27
1300	19.56	0.54	1.05	2.08	4.08	8.10	15.98	31.37	32.14	17.35	4.29
1400	19.48	0.54	1.05	2.08	4.08	8.10	15.99	31.34	31.72	17.34	4.35
1500	19.39	0.54	1.05	2.07	4.07	8.10	15.99	31.32	32.05	17.39	4.40
1600	19.28	0.55	1.06	2.07	4.06	8.10	15.99	31.28	32.27	17.79	4.47
1700	19.17	0.55	1.06	2.07	4.07	8.12	16.02	31.27	32.23	17.64	4.39
1800	19.10	0.55	1.07	2.07	4.08	8.13	16.05	31.27	32.73	18.23	4.37
1900	18.96	0.56	1.08	2.07	4.08	8.15	16.08	31.27	32.66	18.34	4.41
2000	18.79	0.56	1.09	2.08	4.09	8.17	16.12	31.27	32.21	18.55	4.44
2200	18.45	0.57	1.10	2.09	4.12	8.24	16.22	31.33	31.81	18.32	4.39
2400	18.07	0.58	1.13	2.12	4.17	8.35	16.37	31.40	31.10	17.59	4.34
2600	17.21	0.60	1.16	2.17	4.25	8.48	16.54	31.49	30.39	17.06	4.34
2800	17.39	0.63	1.21	2.26	4.40	8.73	16.84	31.68	30.41	17.24	4.33
3000	17.01	0.65	1.23	2.33	4.50	8.90	17.02	31.66	30.06	16.98	4.30



P.O. Box 350166, Brooklyn, New York 11235-0003 (718) 934-4500 • Fax (718) 332-4661 For detailed performance specs & shopping online see Mini-Circuits web site www.minicircuits.com



The Design Engineers Search Engine Provides ACTUAL Data Instantly From MINI-CIRCUITS At: www.minicircuits.com

IF/RF MICROWAVE COMPONENTS

REV. OR

DVGA2-33A+

6/7/2016

Page 2 of 9

Digital Variable Gain Amplifier

DVGA2-33A+

Typical Performance Data

TEST CONDITIONS: Vd1 = +3V, Vd2 = +5V @ Temperature = +85degC

FREQ	GAIN @ 0dB Step	STEP ATTENUATION @							Output IP3 @ 0dB Step	Pout at 1dB Comp @ 0dB Step	Noise Figure @ 0dB Step
		0.5 dB	1.0 dB	2 dB	4 dB	8 dB	16 dB	31.5 dB			
(MHz)	(dB)	(dB)	(dB)	(dB)	(dB)	(dB)	(dB)	(dB)	(dBm)	(dBm)	(dB)
50	20.15	0.51	1.00	1.99	3.97	7.88	15.86	31.16	31.26	16.63	5.84
60	20.02	0.51	1.00	1.98	3.95	7.87	15.85	31.15	31.69	16.83	5.51
70	19.93	0.51	1.00	1.97	3.95	7.86	15.85	31.14	31.88	17.11	5.61
80	19.87	0.51	1.00	1.97	3.94	7.85	15.84	31.11	31.59	17.08	5.80
90	19.82	0.51	1.00	1.96	3.94	7.85	15.84	31.11	31.34	17.02	5.49
100	19.79	0.51	1.00	1.96	3.93	7.84	15.83	31.12	31.58	17.37	5.42
200	19.61	0.51	1.00	1.96	3.93	7.84	15.82	31.10	31.66	17.30	5.44
300	19.51	0.51	1.00	1.97	3.94	7.85	15.82	31.10	32.00	17.35	5.56
400	19.40	0.51	1.00	1.98	3.95	7.85	15.82	31.10	32.71	17.36	5.57
500	19.28	0.50	0.99	1.99	3.96	7.85	15.80	31.09	30.87	16.66	5.66
600	19.18	0.50	0.99	1.99	3.96	7.85	15.78	31.07	31.26	16.92	5.75
700	19.05	0.50	0.98	1.99	3.96	7.85	15.77	31.05	30.96	16.81	5.81
800	18.95	0.50	0.98	1.99	3.96	7.84	15.75	31.03	31.09	16.86	5.87
900	18.89	0.50	0.98	1.99	3.95	7.83	15.74	31.01	31.13	16.90	5.89
1000	18.82	0.50	0.98	1.99	3.95	7.83	15.74	30.99	29.64	16.38	5.94
1100	18.75	0.50	0.98	1.99	3.95	7.84	15.75	30.97	30.53	16.71	5.97
1200	18.67	0.50	0.98	1.99	3.94	7.84	15.75	30.96	30.74	16.79	6.05
1300	18.59	0.50	0.99	1.99	3.94	7.84	15.77	30.95	30.98	17.24	6.12
1400	18.49	0.51	1.00	1.98	3.94	7.85	15.79	30.96	30.55	17.19	6.15
1500	18.38	0.51	1.00	1.98	3.93	7.85	15.80	30.95	30.88	17.18	6.17
1600	18.23	0.51	1.01	1.96	3.91	7.83	15.80	30.93	31.01	17.43	6.27
1700	18.07	0.52	1.01	1.96	3.92	7.85	15.83	30.95	30.87	17.20	6.20
1800	17.94	0.52	1.02	1.96	3.90	7.84	15.84	30.94	31.21	17.57	6.16
1900	17.76	0.52	1.02	1.95	3.90	7.84	15.86	30.96	30.90	17.50	6.20
2000	17.54	0.53	1.03	1.94	3.88	7.83	15.86	30.96	30.56	17.53	6.22
2200	17.08	0.53	1.03	1.94	3.88	7.85	15.90	31.01	30.08	17.18	6.26
2400	16.60	0.54	1.04	1.96	3.91	7.90	15.99	31.11	29.15	16.32	6.23
2600	15.99	0.55	1.06	2.01	3.98	8.02	16.14	31.24	28.68	15.80	6.32
2800	15.73	0.56	1.08	2.06	4.06	8.16	16.31	31.37	28.56	15.57	6.33
3000	15.24	0.57	1.10	2.12	4.15	8.30	16.46	31.36	28.19	15.26	6.38



P.O. Box 350166, Brooklyn, New York 11235-0003 (718) 934-4500 • Fax (718) 332-4661 For detailed performance specs & shopping online see Mini-Circuits web site www.minicircuits.com



The Design Engineers Search Engine Provides ACTUAL Data Instantly From MINI-CIRCUITS At: www.minicircuits.com

IF/RF MICROWAVE COMPONENTS

REV. OR

DVGA2-33A+

6/7/2016

Page 3 of 9

Typical Performance Data

TEST CONDITIONS: Vd1 = +3V, Vd2 = +5V @ Temperature = +25degC

FREQ	INPUT RETURN LOSS @							
	0 dB	0.5 dB	1 dB	2 dB	4 dB	8 dB	16 dB	31.5 dB
(MHz)	(dB)	(dB)	(dB)	(dB)	(dB)	(dB)	(dB)	(dB)
50	13.19	14.36	15.50	16.33	18.91	23.34	40.97	39.05
60	14.05	16.08	17.22	17.83	20.05	23.95	41.58	39.00
70	14.89	17.60	18.77	19.04	20.94	24.40	41.96	39.38
80	15.67	19.01	20.23	20.17	21.65	24.72	41.63	39.42
90	16.34	20.31	21.61	21.05	22.23	24.93	41.77	39.25
100	17.08	21.48	22.82	21.78	22.60	25.03	41.63	39.61
200	17.72	27.30	29.35	23.87	23.35	24.95	39.22	41.58
300	18.33	23.62	24.98	22.09	22.13	24.17	36.83	41.12
400	18.96	20.44	21.62	20.13	20.83	23.25	34.57	39.07
500	19.50	18.15	19.15	18.40	19.45	22.22	32.28	35.78
600	20.06	16.65	17.61	17.15	18.39	21.32	30.25	32.54
700	24.16	15.45	16.35	16.11	17.46	20.46	28.48	29.93
800	25.11	14.50	15.37	15.26	16.67	19.72	26.92	27.68
900	23.75	14.01	14.83	14.74	16.14	19.10	25.51	25.69
1000	22.11	13.66	14.43	14.37	15.72	18.60	24.16	23.93
1100	20.54	13.52	14.26	14.17	15.46	18.19	23.01	22.34
1200	19.22	13.51	14.18	14.08	15.26	17.84	21.89	20.92
1300	18.00	13.58	14.19	14.06	15.15	17.50	20.82	19.65
1400	17.03	13.75	14.27	14.13	15.08	17.21	19.85	18.50
1500	16.22	13.96	14.37	14.23	15.05	16.94	18.93	17.48
1600	15.62	14.08	14.36	14.29	14.98	16.65	18.07	16.54
1700	15.03	13.68	13.87	13.96	14.65	16.21	17.25	15.72
1800	14.46	13.65	13.77	13.94	14.56	15.93	16.54	14.99
1900	13.95	13.24	13.29	13.63	14.27	15.53	15.84	14.31
2000	13.55	12.76	12.77	13.27	13.93	15.12	15.19	13.71
2200	13.36	11.96	11.96	12.68	13.41	14.43	14.07	12.71
2400	13.08	11.50	11.47	12.33	13.06	13.85	13.15	11.92
2600	12.91	11.21	11.19	12.20	12.97	13.52	12.49	11.40
2800	12.77	11.71	11.61	12.69	13.27	13.33	12.00	11.06
3000	12.67	11.98	11.87	13.03	13.56	13.26	11.73	10.91

Typical Performance Data

TEST CONDITIONS: Vd1 = +3V, Vd2 = +5V @ Temperature = -40degC

FREQ	INPUT RETURN LOSS @							
	0 dB	0.5 dB	1 dB	2 dB	4 dB	8 dB	16 dB	31.5 dB
(MHz)	(dB)	(dB)	(dB)	(dB)	(dB)	(dB)	(dB)	(dB)
50	13.30	14.55	15.75	17.22	21.01	29.81	26.20	23.38
60	14.17	16.32	17.51	18.92	22.64	31.52	26.20	23.47
70	15.05	17.91	19.12	20.45	24.03	33.12	26.35	23.60
80	15.84	19.41	20.64	21.83	25.29	34.52	26.45	23.73
90	16.59	20.84	22.11	23.10	26.48	36.01	26.61	23.80
100	17.34	22.20	23.54	24.24	27.33	37.07	26.76	23.91
200	18.03	33.50	40.32	29.35	29.87	36.75	27.43	24.40
300	18.73	26.32	27.38	26.03	27.37	31.98	26.04	23.45
400	19.39	22.49	23.49	23.41	25.47	30.78	25.56	22.99
500	20.03	19.92	21.04	21.17	23.52	29.62	26.29	23.48
600	20.64	18.05	19.18	19.30	21.58	27.33	27.32	24.12
700	26.10	16.41	17.48	17.68	19.89	24.94	27.27	24.12
800	28.61	15.19	16.19	16.47	18.59	23.24	26.03	23.26
900	26.96	14.72	15.67	15.93	17.94	22.09	24.55	22.11
1000	24.69	14.33	15.21	15.50	17.42	21.26	23.21	21.04
1100	22.74	14.06	14.92	15.18	17.01	20.54	22.09	20.05
1200	21.19	13.93	14.73	14.96	16.65	19.81	20.98	19.11
1300	19.76	13.88	14.61	14.81	16.34	19.13	19.93	18.15
1400	18.64	13.92	14.57	14.72	16.07	18.46	18.90	17.23
1500	17.60	13.92	14.45	14.58	15.72	17.65	17.81	16.25
1600	16.81	13.82	14.22	14.34	15.32	16.85	16.72	15.30
1700	16.00	13.59	13.88	14.07	14.94	16.24	15.88	14.50
1800	15.26	13.51	13.72	13.96	14.70	15.73	15.15	13.83
1900	14.62	13.09	13.24	13.54	14.23	15.11	14.42	13.18
2000	14.09	12.65	12.76	13.15	13.80	14.53	13.74	12.57
2200	13.84	12.02	12.07	12.58	13.20	13.68	12.70	11.65
2400	13.66	11.44	11.45	12.05	12.57	12.78	11.68	10.74
2600	13.47	10.75	10.80	11.54	12.11	12.17	10.94	10.12
2800	13.31	11.61	11.52	12.22	12.46	11.92	10.45	9.73
3000	13.14	12.02	11.92	12.64	12.72	11.83	10.21	9.56

Typical Performance Data

TEST CONDITIONS: Vd1 = +3V, Vd2 = +5V @ Temperature = +85degC

FREQ	INPUT RETURN LOSS @							
	0 dB	0.5 dB	1 dB	2 dB	4 dB	8 dB	16 dB	31.5 dB
(MHz)	(dB)	(dB)	(dB)	(dB)	(dB)	(dB)	(dB)	(dB)
50	12.99	14.08	15.09	15.36	16.90	19.16	24.64	28.26
60	13.79	15.66	16.70	16.59	17.77	19.54	24.77	28.37
70	14.58	17.07	18.05	17.58	18.36	19.79	24.89	28.34
80	15.29	18.31	19.37	18.42	18.86	19.99	25.00	28.53
90	15.96	19.44	20.49	19.10	19.25	20.16	25.13	28.67
100	16.62	20.40	21.48	19.59	19.49	20.25	25.17	28.78
200	17.20	24.27	25.34	21.00	20.09	20.48	25.39	29.11
300	17.74	21.35	22.24	19.49	19.08	19.78	24.39	27.75
400	18.29	18.54	19.36	17.68	17.77	18.80	23.07	25.99
500	18.76	16.43	17.21	16.16	16.59	17.91	22.04	24.56
600	19.22	15.07	15.81	15.09	15.72	17.23	21.29	23.47
700	22.41	14.04	14.75	14.26	15.03	16.71	20.72	22.64
800	23.03	13.33	14.01	13.63	14.49	16.29	20.22	21.85
900	21.83	12.90	13.55	13.21	14.09	15.88	19.64	20.93
1000	20.33	12.68	13.28	12.97	13.81	15.58	19.13	20.05
1100	18.87	12.68	13.23	12.91	13.68	15.40	18.69	19.23
1200	17.58	12.84	13.35	12.99	13.69	15.33	18.35	18.51
1300	16.46	13.11	13.56	13.16	13.77	15.30	18.02	17.83
1400	15.57	13.48	13.83	13.45	13.94	15.36	17.78	17.23
1500	14.83	13.87	14.11	13.74	14.13	15.44	17.52	16.68
1600	14.26	14.08	14.20	13.94	14.26	15.48	17.24	16.15
1700	13.74	13.86	13.93	13.85	14.20	15.45	16.93	15.64
1800	13.26	13.89	13.86	13.97	14.33	15.51	16.67	15.20
1900	12.88	13.49	13.43	13.76	14.21	15.42	16.33	14.75
2000	12.56	13.00	12.93	13.47	14.03	15.30	15.96	14.32
2200	12.37	12.13	12.07	12.94	13.70	15.03	15.25	13.58
2400	12.15	11.58	11.52	12.61	13.50	14.77	14.53	12.95
2600	12.02	11.23	11.18	12.45	13.47	14.63	13.96	12.54
2800	11.97	11.47	11.40	12.80	13.77	14.55	13.51	12.29
3000	11.92	11.86	11.77	13.33	14.26	14.65	13.24	12.20

Typical Performance Data

TEST CONDITIONS: Vd1 = +3V, Vd2 = +5V @ Temperature = +25degC

FREQ	OUTPUT RETURN LOSS @							
	0 dB	0.5 dB	1 dB	2 dB	4 dB	8 dB	16 dB	31.5 dB
(MHz)	(dB)	(dB)	(dB)	(dB)	(dB)	(dB)	(dB)	(dB)
50	24.21	23.60	23.41	20.31	19.16	18.42	19.08	16.63
60	26.21	27.26	27.00	22.63	21.17	20.18	21.06	17.99
70	28.20	30.78	30.34	24.41	22.62	21.46	22.45	18.96
80	30.18	34.62	33.94	25.88	23.70	22.44	23.53	19.65
90	32.29	38.59	37.43	26.87	24.44	23.04	24.31	20.09
100	34.62	42.03	40.31	27.49	24.91	23.49	24.77	20.37
200	37.05	29.42	29.28	25.61	23.88	22.91	24.11	20.11
300	39.53	24.86	24.79	22.48	21.40	20.80	21.70	18.64
400	43.48	22.15	22.11	20.22	19.42	19.05	19.83	17.25
500	48.94	20.04	20.00	18.37	17.77	17.50	18.21	15.99
600	55.08	18.84	18.83	17.32	16.81	16.62	17.33	15.23
700	34.75	17.98	17.99	16.54	16.12	15.99	16.67	14.68
800	29.52	17.06	17.10	15.75	15.40	15.33	15.98	14.11
900	27.00	16.64	16.71	15.38	15.06	15.00	15.65	13.80
1000	25.21	16.63	16.71	15.34	15.02	14.95	15.58	13.75
1100	23.60	16.87	16.98	15.54	15.23	15.15	15.78	13.92
1200	22.49	17.50	17.61	16.05	15.72	15.60	16.19	14.28
1300	21.33	18.28	18.45	16.76	16.40	16.25	16.80	14.80
1400	20.32	19.25	19.46	17.67	17.29	17.11	17.62	15.48
1500	19.64	20.11	20.44	18.69	18.33	18.18	18.67	16.23
1600	19.07	19.91	20.33	19.06	18.93	18.99	19.62	16.84
1700	18.57	19.85	20.38	19.50	19.57	19.78	20.42	17.35
1800	18.19	17.85	18.38	18.23	18.65	19.49	20.54	17.04
1900	17.68	16.67	17.15	17.28	17.86	18.97	20.16	16.57
2000	17.22	15.53	15.99	16.20	16.79	17.97	19.16	15.79
2200	17.05	14.15	14.49	14.58	14.97	15.85	16.66	13.99
2400	16.80	13.82	14.08	13.86	13.91	14.32	14.76	12.59
2600	16.69	15.48	15.48	14.43	13.82	13.39	13.27	11.80
2800	16.75	14.68	14.54	13.32	12.56	12.02	11.81	10.56
3000	16.78	14.82	14.54	13.06	12.16	11.47	11.18	10.22

Digital Variable Gain Amplifier

DVGA2-33A+

Typical Performance Data

TEST CONDITIONS: Vd1 = +3V, Vd2 = +5V @ Temperature = -40degC

FREQ	OUTPUT RETURN LOSS @							
	0 dB	0.5 dB	1 dB	2 dB	4 dB	8 dB	16 dB	31.5 dB
(MHz)	(dB)	(dB)	(dB)	(dB)	(dB)	(dB)	(dB)	(dB)
50	24.29	23.21	22.72	19.39	17.87	16.74	16.94	15.01
60	26.35	26.76	26.02	21.38	19.53	18.12	18.39	16.13
70	28.43	29.91	28.81	22.81	20.62	19.07	19.32	16.84
80	30.27	32.72	31.24	23.79	21.35	19.67	19.99	17.29
90	32.44	34.68	32.85	24.37	21.80	20.05	20.36	17.57
100	34.43	35.52	33.49	24.65	22.01	20.22	20.55	17.71
200	36.81	29.13	28.83	23.92	21.78	20.21	20.58	17.79
300	38.66	25.30	25.19	22.59	20.97	19.74	20.08	17.48
400	41.01	22.21	22.12	20.35	19.18	18.24	18.56	16.37
500	42.52	20.06	19.89	18.28	17.34	16.62	16.88	15.06
600	42.58	18.69	18.56	17.06	16.27	15.69	15.97	14.28
700	33.99	17.67	17.55	16.12	15.43	14.94	15.23	13.64
800	29.87	16.75	16.67	15.33	14.72	14.29	14.59	13.10
900	27.48	16.30	16.22	14.92	14.36	13.96	14.26	12.77
1000	25.46	15.98	15.93	14.66	14.10	13.71	13.99	12.53
1100	23.68	15.81	15.76	14.49	13.95	13.56	13.83	12.37
1200	22.40	15.96	15.92	14.60	14.04	13.63	13.87	12.39
1300	21.37	16.23	16.20	14.85	14.28	13.83	14.05	12.54
1400	20.38	16.67	16.67	15.28	14.69	14.22	14.41	12.84
1500	19.62	17.08	17.14	15.81	15.21	14.71	14.88	13.20
1600	19.02	16.91	17.04	15.93	15.41	14.98	15.14	13.39
1700	18.43	17.06	17.24	16.27	15.77	15.31	15.45	13.62
1800	17.97	15.99	16.22	15.54	15.22	14.90	15.08	13.26
1900	17.57	15.45	15.70	15.28	15.02	14.80	14.95	13.10
2000	17.03	14.77	15.02	14.71	14.52	14.35	14.52	12.72
2200	16.82	13.82	14.03	13.76	13.53	13.34	13.41	11.80
2400	16.55	13.32	13.43	13.00	12.59	12.21	12.15	10.76
2600	16.34	15.83	15.65	14.31	13.27	12.29	11.92	10.92
2800	16.19	13.41	13.14	11.91	10.94	10.09	9.76	8.92
3000	16.04	13.42	13.01	11.55	10.47	9.53	9.15	8.49



Typical Performance Data

TEST CONDITIONS: Vd1 = +3V, Vd2 = +5V @ Temperature = +85degC

FREQ	OUTPUT RETURN LOSS @							
	0 dB	0.5 dB	1 dB	2 dB	4 dB	8 dB	16 dB	31.5 dB
(MHz)	(dB)	(dB)	(dB)	(dB)	(dB)	(dB)	(dB)	(dB)
50	24.12	23.66	23.71	21.03	20.28	19.90	21.13	18.13
60	26.02	27.42	27.49	23.64	22.54	22.11	23.63	19.81
70	27.93	30.99	31.16	25.70	24.44	23.91	25.75	21.07
80	29.74	35.00	35.06	27.66	26.00	25.34	27.66	22.08
90	31.81	40.04	40.30	29.19	27.23	26.47	29.29	22.74
100	33.84	48.91	49.11	30.42	28.12	27.30	30.61	23.25
200	36.21	29.29	29.30	27.44	26.35	26.00	28.01	22.78
300	38.55	24.51	24.54	22.64	21.95	21.85	23.07	19.75
400	41.50	21.86	21.87	20.06	19.57	19.57	20.69	17.83
500	44.94	19.82	19.92	18.30	17.98	18.09	19.21	16.61
600	49.15	18.65	18.78	17.30	17.09	17.30	18.41	15.92
700	34.38	17.80	17.96	16.59	16.44	16.68	17.78	15.43
800	29.13	17.14	17.34	16.04	15.95	16.22	17.29	15.04
900	26.69	16.99	17.21	15.90	15.85	16.13	17.17	14.98
1000	24.85	17.32	17.55	16.18	16.16	16.42	17.42	15.26
1100	23.28	18.11	18.39	16.84	16.81	17.07	17.98	15.83
1200	22.12	19.37	19.69	17.90	17.85	18.00	18.83	16.66
1300	20.87	21.09	21.50	19.33	19.23	19.30	19.99	17.73
1400	19.97	22.97	23.63	21.05	20.99	21.03	21.53	19.08
1500	19.35	24.10	25.12	22.81	23.05	23.35	23.66	20.63
1600	18.77	22.93	23.89	23.20	24.27	25.94	26.61	22.11
1700	18.30	21.38	22.24	22.50	24.06	27.28	29.12	22.59
1800	17.87	18.59	19.26	19.94	21.60	25.81	31.67	21.74
1900	17.45	16.95	17.53	18.23	19.73	23.43	28.55	20.25
2000	17.15	15.68	16.20	16.76	18.03	21.13	24.90	18.60
2200	17.09	14.17	14.58	14.89	15.74	17.84	20.04	15.81
2400	16.97	13.98	14.31	14.27	14.76	16.13	17.45	14.16
2600	17.05	15.30	15.46	14.70	14.59	14.98	15.36	13.15
2800	17.29	15.19	15.21	14.13	13.71	13.73	13.82	12.03
3000	17.57	15.85	15.70	14.25	13.59	13.27	13.11	11.75

Typical Performance Curves

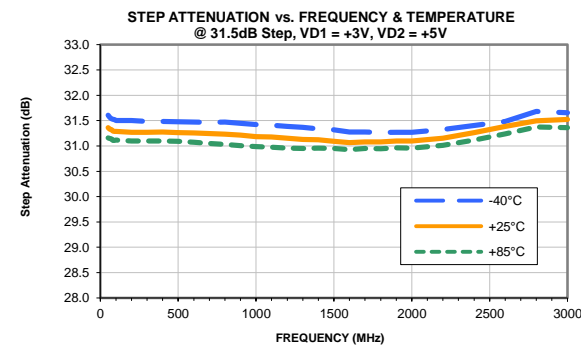
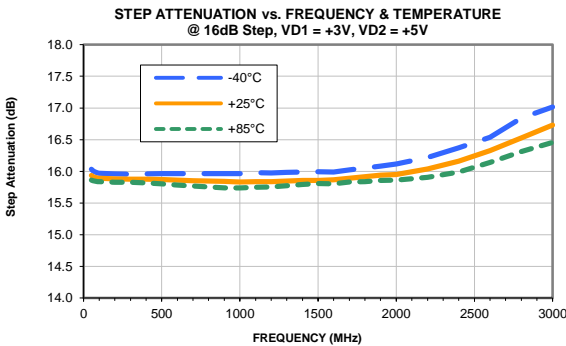
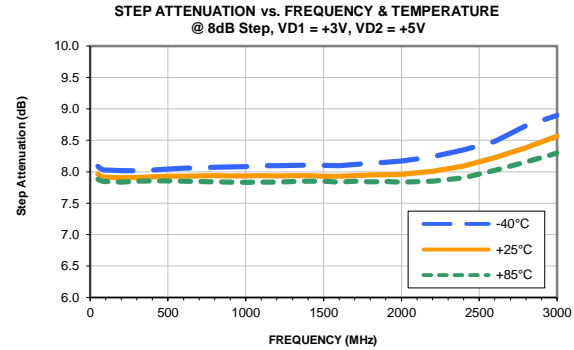
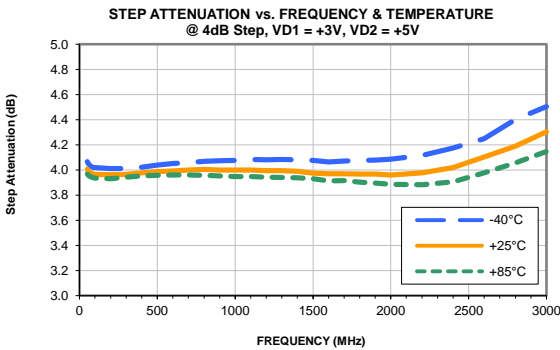
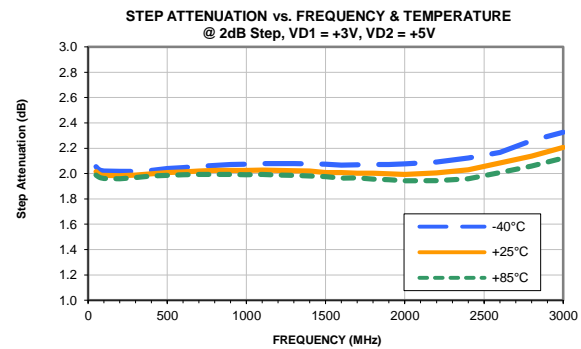
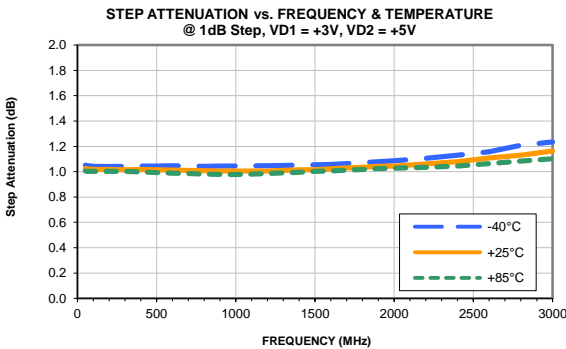
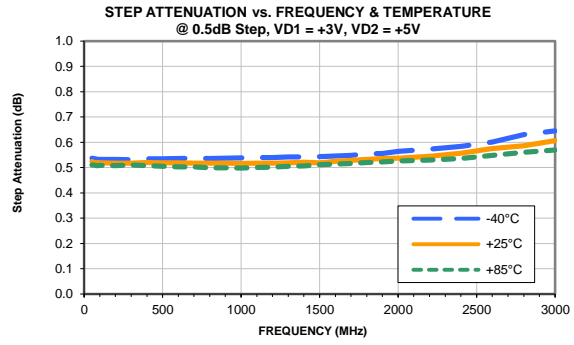
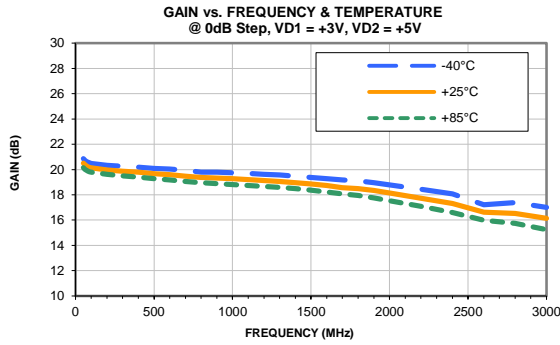

Typical Performance Curves

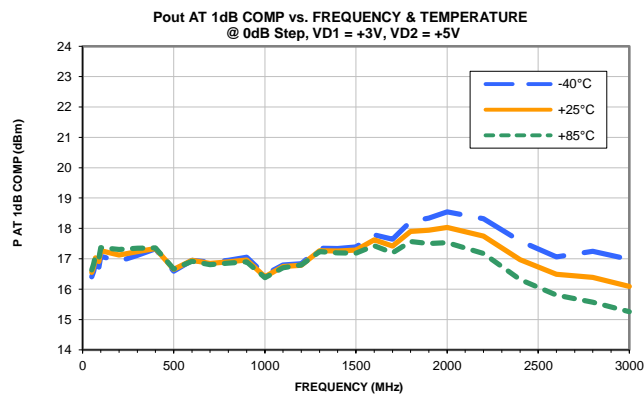
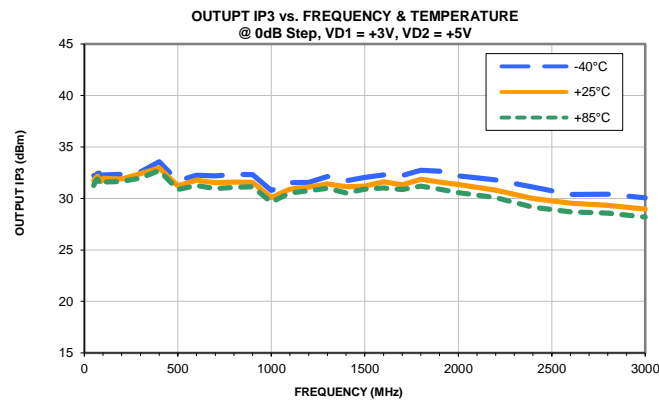
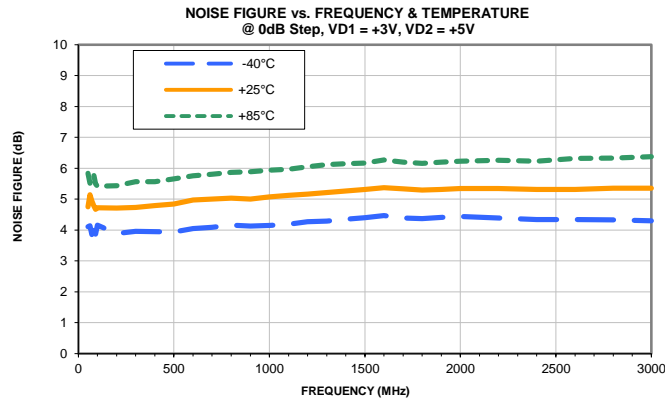

Typical Performance Curves

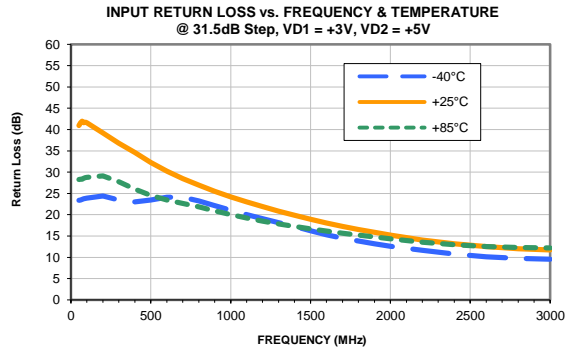
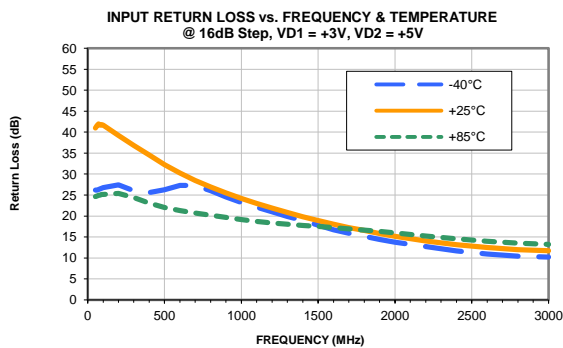
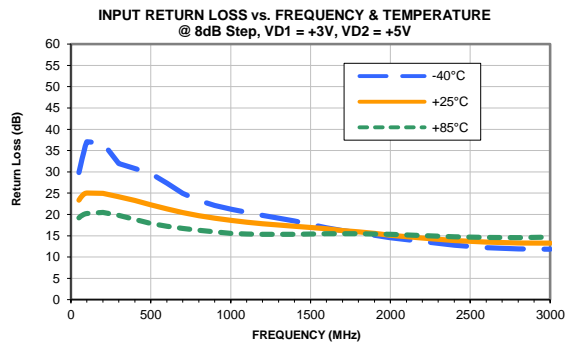
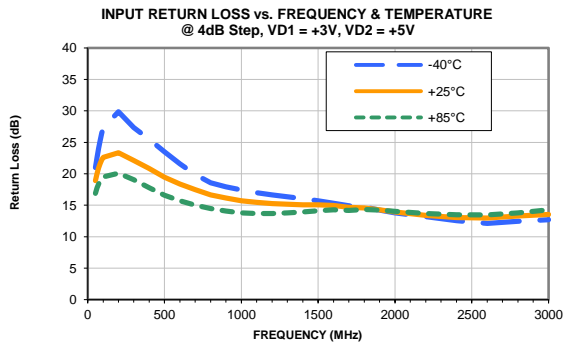
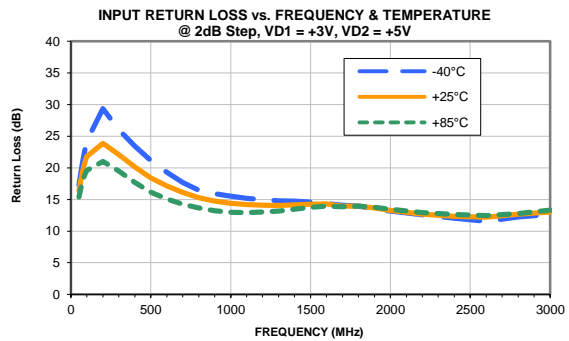
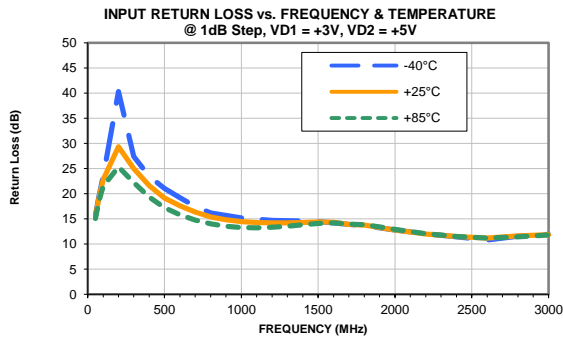
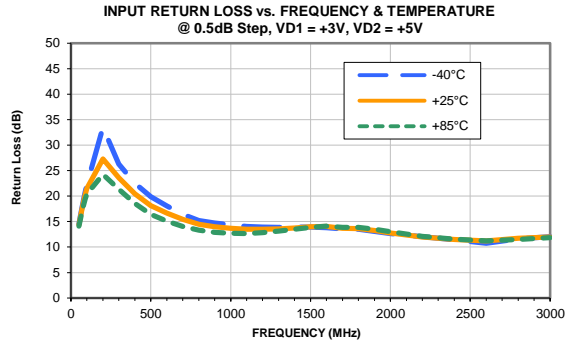
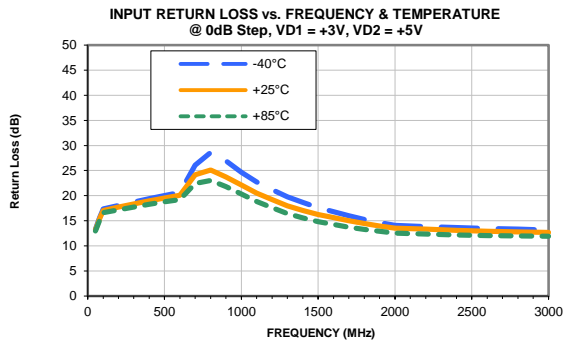

Typical Performance Curves

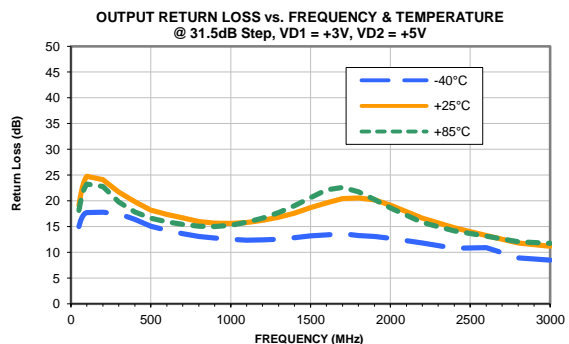
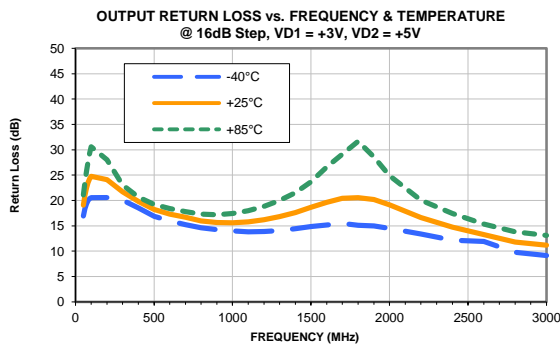
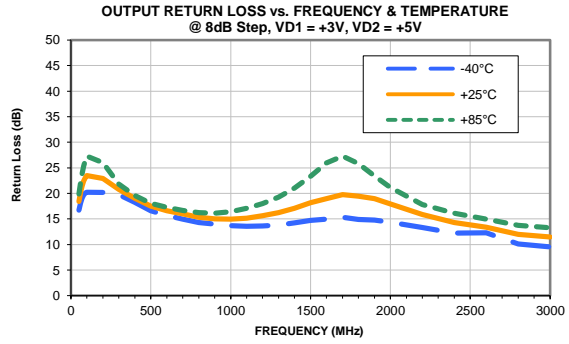
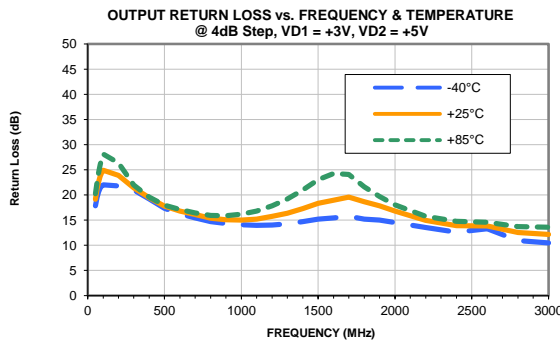
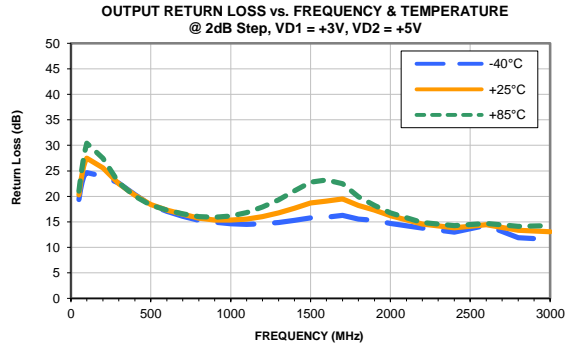
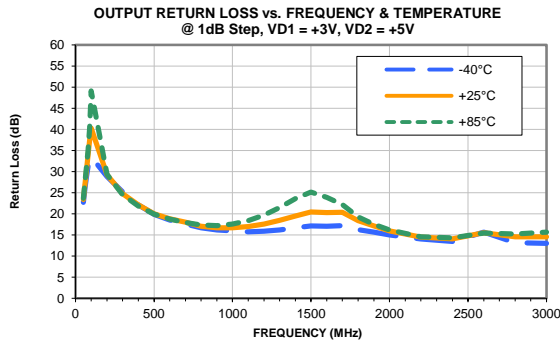
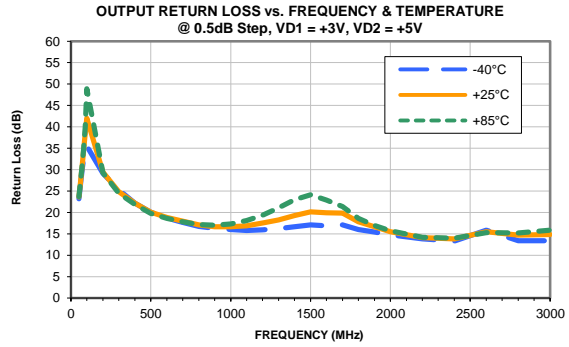
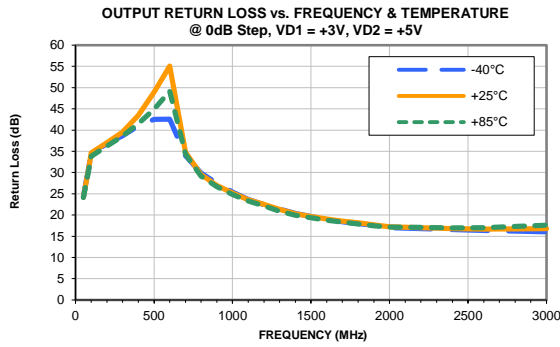

Outline Dimensions

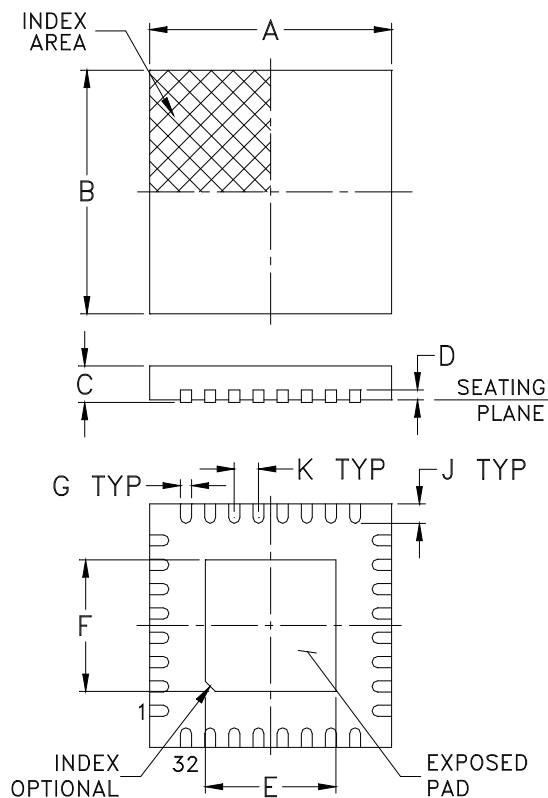

PCB Land Pattern

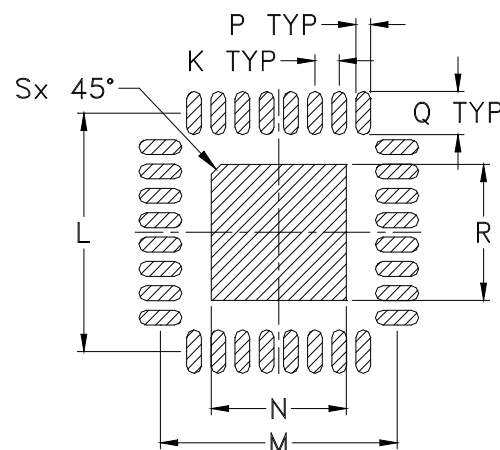

Suggested Layout,
Tolerance to be within $\pm .002$

CASE #	A	B	C MAX	C MIN	D	E	F	G	H	J
DG1677	.197 (5.00)	.197 (5.00)	.039 (1.00)	.031 (0.80)	.008 (0.20)	.106 (2.70)	.106 (2.70)	.009 (0.23)	-	.016 (0.40)

CASE #	K	L	M	N	P	Q	R	S	WT. GRAM
DG1677	.020 (0.50)	.193 (4.90)	.193 (4.90)	.110 (2.79)	.012 (0.30)	.035 (0.89)	.110 (2.79)	.008 (0.20)	.05

Dimensions are in inches (mm). Tolerances: 2 Pl. $\pm .01$; 3 Pl. $\pm .005$

Notes:

1. Case material: Plastic.
2. Termination finish:

For RoHS Case Styles: Pre-plated (Ni Pd Au), transitioning to Matt-Tin. All models, (+) suffix.
For RoHS-5 Case Styles: Tin-Lead plate. All models, no (+) suffix.

Tape & Reel Packaging TR-F68

DEVICE ORIENTATION IN T&R

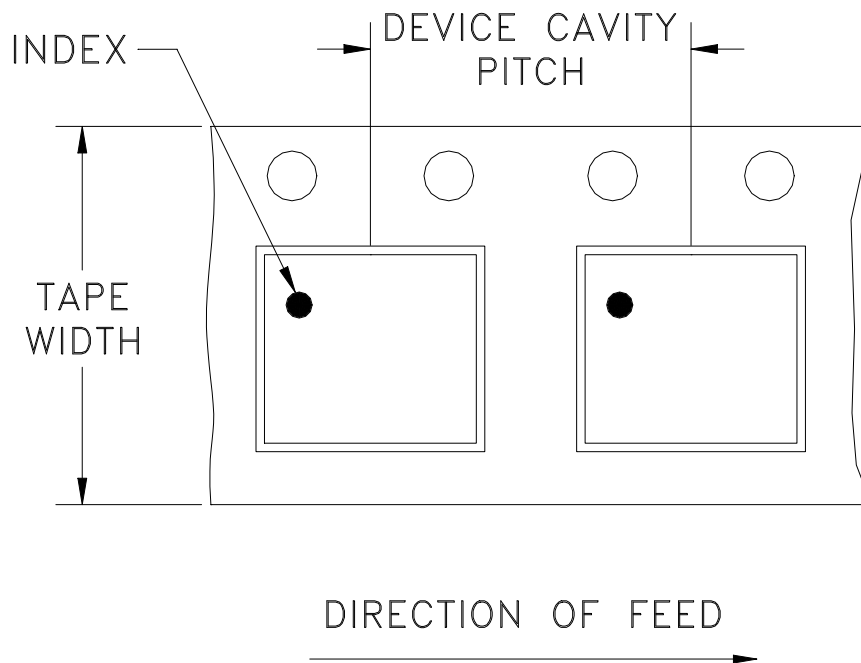

Tape Width, mm	Device Cavity Pitch, mm	Reel Size, inches	Devices per Reel see note	
12	8	7	Small quantity standard	20
				50
				100
				200
				500
		7	Standard	1000
		13	Standard	2000
				3000
				4000

Mini-Circuits carrier tape materials provide protection from ESD (Electro-Static Discharge) during handling and transportation. Tapes are static dissipative and comply with industry standards EIA-481/EIA-541.

Go to: www.minicircuits.com/pages/pdfs/tape.pdf



INTERNET <http://www.minicircuits.com>

P.O. Box 350166, Brooklyn, New York 11235-0003 (718) 934-4500 Fax (718) 332-4661

Distribution Centers NORTH AMERICA 800-654-7949 • 417-335-5935 • Fax 417-335-5945 • EUROPE 44-1252-832600 • Fax 44-1252-837010

Mini-Circuits ISO 9001 & ISO 14001 Certified

THIRD ANGLE PROJECTION

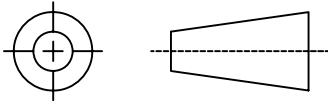

REVISIONS

REV	ECN No.	DESCRIPTION	DATE	DR	AUTH
OR	M137309	NEW RELEASE	06/08/12	AV	SL
A	M138545	UPDATED PCB PATTERN AND "L1" SIZE	09/05/12	IL	SL
B	M139207	ADDED CONNECTION BETWEEN PIN 12 & GND	10/26/12	IL	SL
C	M144132	DELETED CONNECT. BETWEEN PIN 19 & VD2	11/19/13	ITG	SL

SUGGESTED MOUNTING CONFIGURATION
FOR DG1677 CASE STYLE, "32AM02" PIN CODE

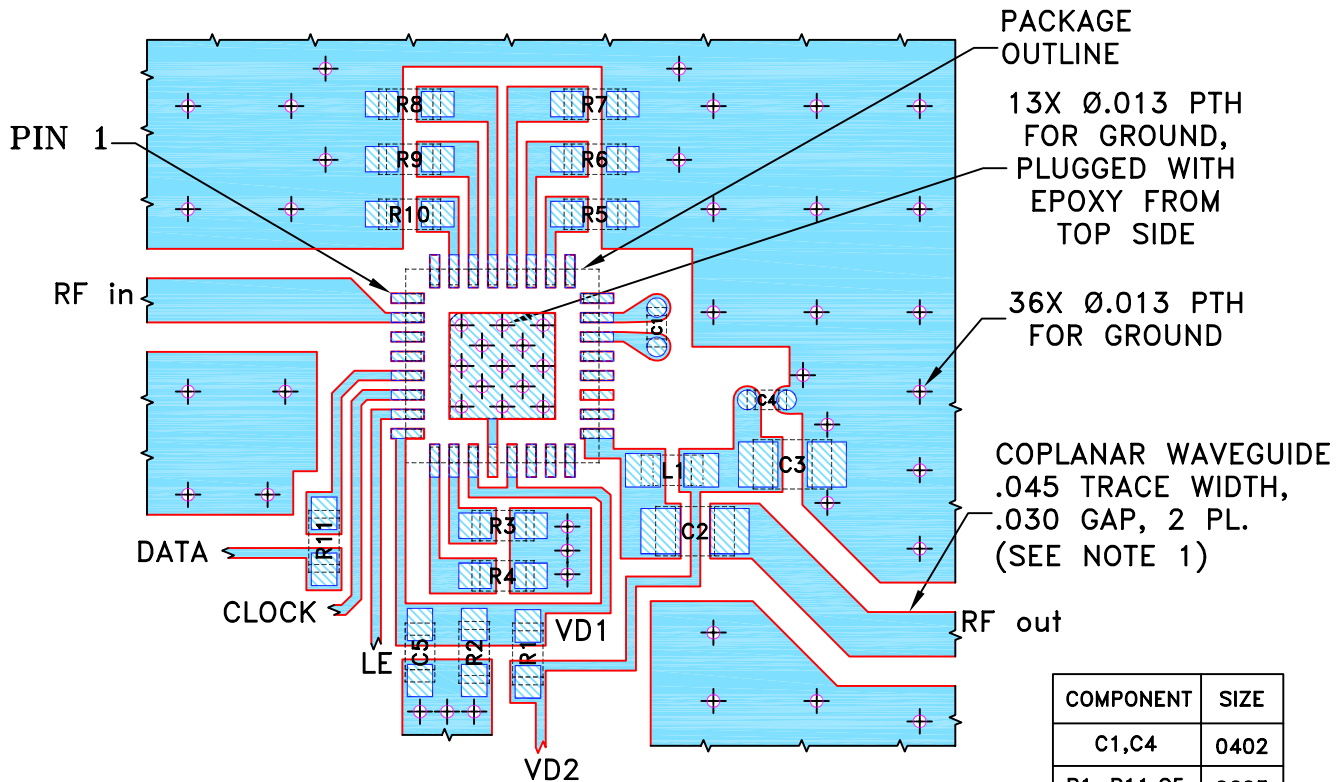

PACKAGE OUTLINE
13X Ø.013 PTH FOR GROUND, PLUGGED WITH EPOXY FROM TOP SIDE
36X Ø.013 PTH FOR GROUND
COPLANAR WAVEGUIDE .045 TRACE WIDTH, .030 GAP, 2 PL. (SEE NOTE 1)

COMPONENT	SIZE
C1,C4	0402
R1-R11,C5	0603
C2,C3	0805
L1	0603

NOTES:

1. COPLANAR WAVEGUIDE PARAMETERS ARE SHOWN FOR IT-180TC WITH DIELECTRIC THICKNESS .024" ± .002". COPPER: 1/2 OZ. EACH SIDE. FOR OTHER MATERIALS TRACE WIDTH AND GAP MAY NEED TO BE MODIFIED.
2. CHIP COMPONENT FOOT PRINTS SHOWN FOR REFERENCE. FOR COMPONENT VALUES REFER TO TB-674+.
3. BOTTOM SIDE OF THE PCB IS CONTINUOUS GROUND PLANE.

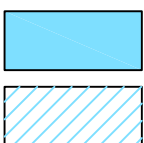

DENOTES PCB COPPER LAYOUT WITH SMOBC (SOLDER MASK OVER BARE COPPER).
DENOTES COPPER LAND PATTERN FREE OF SOLDER MASK.

UNLESS OTHERWISE SPECIFIED	INITIALS	DATE
DIMENSIONS ARE IN INCHES	AV	06/05/12
TOLERANCES ON:	IL	06/08/12
2 PL DECIMALS ±	SL	06/08/12
3 PL DECIMALS ± .005		
ANGLES ±		
FRACTIONS ±		



Mini-Circuits® 13 Neptune Avenue Brooklyn NY 11235

PL, 32AM02, DG1677, TB-674+

THIS DOCUMENT AND ITS CONTENTS ARE THE PROPERTY OF MINI-CIRCUITS. EXCEPT FOR USE EXPRESSLY GRANTED, IN WRITING, TO ITS VENDORS, VENDEE AND THE UNITED STATES GOVERNMENT, MINI-CIRCUITS RESERVES ALL PROPRIETARY DESIGN, USE, MANUFACTURING AND REPRODUCTION RIGHTS THERETO. THESE CONTENTS SHALL NOT BE USED, DUPLICATED OR DISCLOSED TO ANY OUTSIDE PARTY, IN WHOLE OR IN PART, WITHOUT WRITTEN PERMISSION OF MINI-CIRCUITS.

SIZE A	CODE IDENT 15542	DRAWING NO: 98-PL-371	REV: C
FILE: 98PL371	SCALE: 5:1	SHEET: 1 OF 1	

Evaluation Board and Circuit

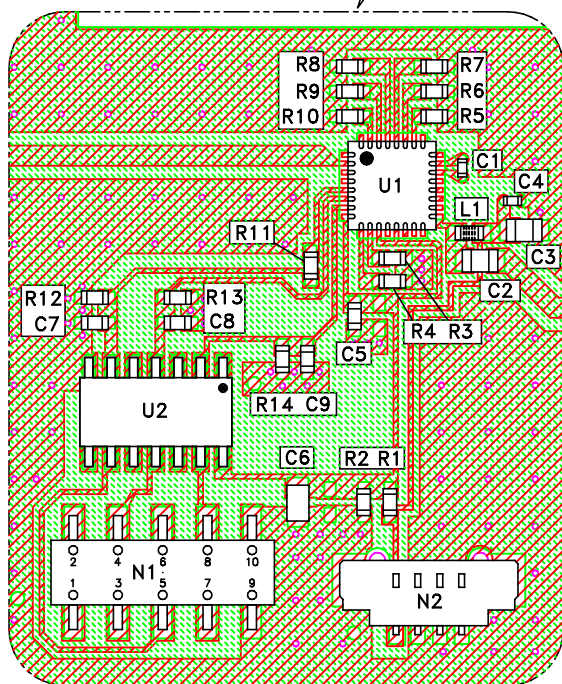
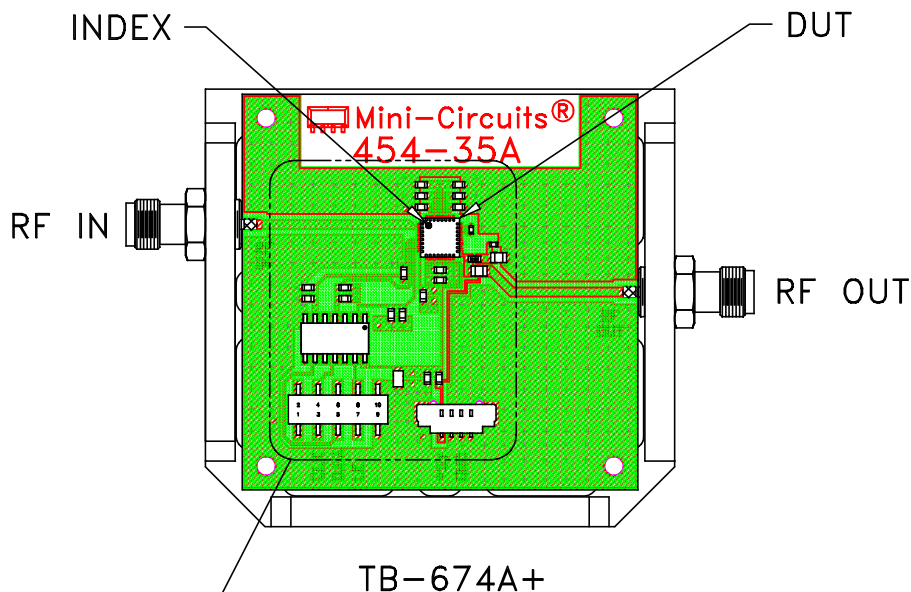

COMPONENT	VALUE/ PART NUMBER	SIZE
U1	DVGA2-33A+	-
U2	Hex Inverting Schmitt Trigger	-
C1	1000 pF	.04 X .02
C2	1000 pF	.08 X .05
C3	1 uF	.08 X .05
C4	100 pF	.04 X .02
C5, C7-C9	100 pF	.06 X .03
C6	.47 uF	.08 X .05
L1	390 nH	.06 X .03
R1	475 Ohm	.06 X .03
R2	681 Ohm	.06 X .03
R3-R14	10 KOhm	.06 X .03
TEST CABLE 1	B66-23+	-
TEST CABLE 2	B66-25+	-

Notes:

1. Test cables for "N1" and "N2" are included in TB-674A+.
2. The test software is available at:
Mini-Circuits website: http://www.minicircuits.com/support/software_download.html
Software name: "Digital Step Attenuator & DVGA".
3. 50 Ohm SMA Female connectors.
4. PCB Material: FR4 or equivalent,
Dielectric Constant=4.6, Thickness=.024 inch.

 **Mini-Circuits®**

All Mini-Circuits products are manufactured under exacting quality assurance and control standards, and are capable of meeting published specifications after being subjected to any or all of the following physical and environmental test.

Specification	Test/Inspection Condition	Reference/Spec
Operating Temperature	-40° to 85°C	Individual Model Data Sheet
Storage Temperature	-55° to 100° C or -65° to 150°	Individual Model Data Sheet
Thermal Shock	-65° to 150°C, 1000 Cycles	JESD22-A104D, condition C
Autoclave	15 psig, 100% RH, 121°C, 168 hours	JESD22-A102D, Condition C
Solderability	10X Magnification	J-STD-002, Para 4.2.5, Test S, 95% Coverage
Moisture Sensitivity: Level 1	Bake at 125°C for 24 hours. Soak at 85°C/85%RH for 168 hours Reflow 3 cycles at 260°C peak	J-STD-020D.01