

# UT54ACS244/UT54ACTS244

## Radiation-Hardened

## Octal Buffers & Line Drivers, Three-State Outputs

### FEATURES

- Three-state outputs drive bus lines or buffer memory address registers
- 1.2μ radiation-hardened CMOS
  - Latchup immune
- High speed
- Low power consumption
- Single 5 volt supply
- Available QML Q or V processes
- Flexible package
  - 20-pin DIP
  - 20-lead flatpack

### DESCRIPTION

The UT54ACS244 and the UT54ACTS244 are non-inverting octal buffer and line drivers which improve the performance and density of three-state memory address drivers, clock drivers, and bus-oriented receivers and transmitters.

The devices are characterized over full military temperature range of -55°C to +125°C.

### FUNCTION TABLE

| INPUTS                         |   | OUTPUT |
|--------------------------------|---|--------|
| $\overline{1G}, \overline{2G}$ | A | Y      |
| L                              | L | L      |
| L                              | H | H      |
| H                              | X | Z      |

### LOGIC SYMBOL

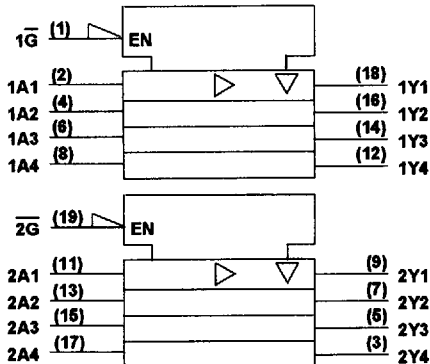

**Note:**

1. Logic symbol in accordance with ANSI/IEEE Std 91-1984 and IEC Publication 617-12.

### PINOUTS

#### 20-Pin DIP Top View

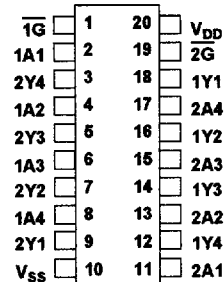

#### 20-Lead Flatpack Top View

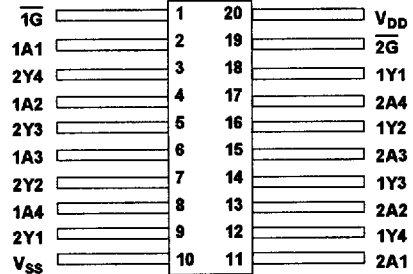

**LOGIC DIAGRAM**

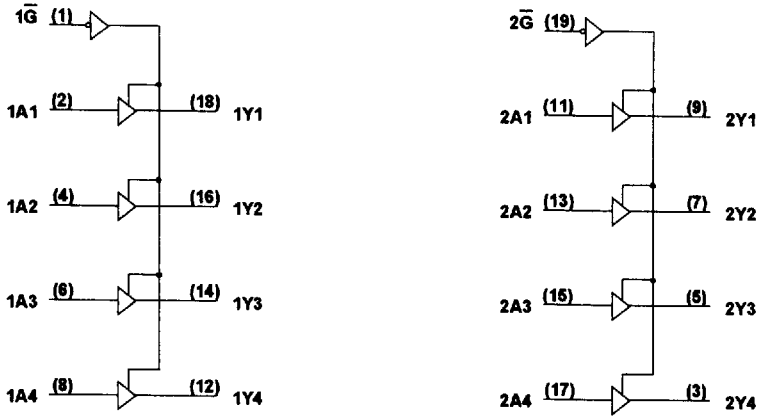

**RADIATION HARDNESS SPECIFICATIONS <sup>1</sup>**

| PARAMETER                  | LIMIT  | UNITS                   |
|----------------------------|--------|-------------------------|
| Total Dose                 | 1.0E6  | rads(Si)                |
| SEU Threshold <sup>2</sup> | 80     | MeV-cm <sup>2</sup> /mg |
| SEL Threshold              | 120    | MeV-cm <sup>2</sup> /mg |
| Neutron Fluence            | 1.0E14 | n/cm <sup>2</sup>       |

- Notes:**  
 1. Logic will not latchup during radiation exposure within the limits defined in the table  
 2. Device storage elements are immune to SEU affects.

**ABSOLUTE MAXIMUM RATINGS**

| SYMBOL           | PARAMETER                              | LIMIT                      | UNITS |
|------------------|--|----------------------------|-------|
| V <sub>DD</sub>  | Supply voltage                         | -0.3 to 7.0                | V     |
| V <sub>I/O</sub> | Voltage any pin                        | -.3 to V <sub>DD</sub> +.3 | V     |
| T <sub>STG</sub> | Storage Temperature range              | -65 to +150                | °C    |
| T <sub>J</sub>   | Maximum junction temperature           | +175                       | °C    |
| T <sub>LS</sub>  | Lead temperature (soldering 5 seconds) | +300                       | °C    |
| θ <sub>JC</sub>  | Thermal resistance junction to case    | 20                         | °C/W  |
| I <sub>I</sub>   | DC input current                       | ±10                        | mA    |
| P <sub>D</sub>   | Maximum power dissipation              | 1                          | W     |

- Note:**  
 1. Stresses outside the listed absolute maximum ratings may cause permanent damage to the device. This is a stress rating only, functional operation of the device at these or any other conditions beyond limits indicated in the operational sections is not recommended. Exposure to absolute maximum rating conditions for extended periods may affect device reliability.

**RECOMMENDED OPERATING CONDITIONS**

| <b>SYMBOL</b> | <b>PARAMETER</b>      | <b>LIMIT</b>  | <b>UNITS</b> |
|---------------|-----------------------|---------------|--------------|
| $V_{DD}$      | Supply voltage        | 4.5 to 5.5    | V            |
| $V_{IN}$      | Input voltage any pin | 0 to $V_{DD}$ | V            |
| $T_C$         | Temperature range     | -55 to + 125  | °C           |

**DC ELECTRICAL CHARACTERISTICS**<sup>7</sup> $(V_{DD} = 5.0V \pm 10\%; V_{SS} = 0V^6, -55^\circ C < T_C < +125^\circ C)$ 

| SYMBOL           | PARAMETER   | CONDITION  | MIN                            | MAX                | UNIT       |
|------------------|---|--|--------------------------------|--------------------|------------|
| $V_{IL}$         | Low-level input voltage <sup>1</sup><br>ACTS<br>ACS     |  |                                | 0.8<br>.3 $V_{DD}$ | V          |
| $V_{IH}$         | High-level input voltage <sup>1</sup><br>ACTS<br>ACS    |  | .5 $V_{DD}$<br>.7 $V_{DD}$     |                    | V          |
| $I_{IN}$         | Input leakage current<br>ACTS/ACS                       | $V_{IN} = V_{DD}$ or $V_{SS}$  | -1                             | 1                  | $\mu A$    |
| $V_{OL}$         | Low-level output voltage <sup>3</sup><br>ACTS<br>ACS    | $I_{OL} = 12.0mA$<br>$I_{OL} = 100\mu A$   |                                | 0.40<br>0.25       | V          |
| $V_{OH}$         | High-level output voltage <sup>3</sup><br>ACTS<br>ACS   | $I_{OH} = -12.0mA$<br>$I_{OH} = -100\mu A$   | .7 $V_{DD}$<br>$V_{DD} - 0.25$ |                    | V          |
| $I_{OL}$         | Output current <sup>10</sup><br>(Sink)                  | $V_{IN} = V_{DD}$ or $V_{SS}$<br>$V_{OL} = 0.4V$   | 12                             |                    | mA         |
| $I_{OH}$         | Output current <sup>10</sup><br>(Source)                | $V_{IN} = V_{DD}$ or $V_{SS}$<br>$V_{OH} = V_{DD} - 0.4V$  | -12                            |                    | mA         |
| $I_{OZ}$         | Three-state output leakage current                      | $V_O = V_{DD}$ and $V_{SS}$  | -30                            | 30                 | $\mu A$    |
| $I_{OS}$         | Short-circuit output current <sup>2,4</sup><br>ACTS/ACS | $V_O = V_{DD}$ and $V_{SS}$  | -300                           | 300                | mA         |
| $P_{total}$      | Power dissipation <sup>2,8,9</sup>                      | $C_L = 50pF$   |                                | 2.0                | mW/<br>MHz |
| $I_{DDQ}$        | Quiescent Supply Current                                | $V_{DD} = 5.5V$  |                                | 10                 | $\mu A$    |
| $\Delta I_{DDQ}$ | Quiescent Supply Current Delta<br>ACTS                  | For input under test<br>$V_{IN} = V_{DD} - 2.1V$<br>For all other inputs<br>$V_{IN} = V_{DD}$ or $V_{SS}$<br>$V_{DD} = 5.5V$ |                                | 1.6                | mA         |
| $C_{IN}$         | Input capacitance <sup>5</sup>                          | $f = 1MHz @ 0V$  |                                | 15                 | pF         |
| $C_{OUT}$        | Output capacitance <sup>5</sup>                         | $f = 1MHz @ 0V$  |                                | 15                 | pF         |

Notes:

1. Functional tests are conducted in accordance with MIL-STD-883 with the following input test conditions:  $V_{IH} = V_{IH}(\text{min}) + 20\%$ ,  $- 0\%$ ;  $V_{IL} = V_{IL}(\text{max}) + 0\%$ ,  $- 50\%$ , as specified herein, for TTL, CMOS, or Schmitt compatible inputs. Devices may be tested using any input voltage within the above specified range, but are guaranteed to  $V_{IH}(\text{min})$  and  $V_{IL}(\text{max})$ .
2. Supplied as a design limit but not guaranteed or tested.
3. Per MIL-PRF-38535, for current density  $\leq 5.0E5$  amps/cm<sup>2</sup>, the maximum product of load capacitance (per output buffer) times frequency should not exceed 3,765 pF/MHz.
4. Not more than one output may be shorted at a time for maximum duration of one second.
5. Capacitance measured for initial qualification and when design changes may affect the value. Capacitance is measured between the designated terminal and  $V_{SS}$  at frequency of 1MHz and a signal amplitude of 50mV rms maximum.
6. Maximum allowable relative shift equals 50mV.
7. All specifications valid for radiation dose  $\leq 1E6$  rads(Si).
8. Power does not include power contribution of any TTL output sink current.
9. Power dissipation specified per switching output.
10. This value is guaranteed based on characterization data, but not tested.

**AC ELECTRICAL CHARACTERISTICS <sup>2</sup>** $(V_{DD} = 5.0V \pm 10\%; V_{SS} = 0V^1, -55^\circ C < T_C < +125^\circ C)$ 

| SYMBOL    | PARAMETER                           | MINIMUM | MAXIMUM | UNIT |
|-----------|-------------------------------------|---------|---------|------|
| $t_{PLH}$ | Input to $Y_n$                      | 1       | 11      | ns   |
| $t_{PHL}$ | Input to $Y_n$                      | 1       | 11      | ns   |
| $t_{PZL}$ | $\bar{G}$ low to $Y_n$ active       | 2       | 12      | ns   |
| $t_{PZH}$ | $\bar{G}$ low to $Y_n$ active       | 2       | 12      | ns   |
| $t_{PLZ}$ | $\bar{G}$ high to $Y_n$ three-state | 2       | 12      | ns   |
| $t_{PHZ}$ | $\bar{G}$ high to $Y_n$ three-state | 2       | 12      | ns   |

**Notes:**

1. Maximum allowable relative shift equals 50mV.
2. All specifications valid for radiation dose  $\leq 1E6$  rads(Si).

## 2.0 RADHARD MSI PACKAGES

### Side-Brazed Packages

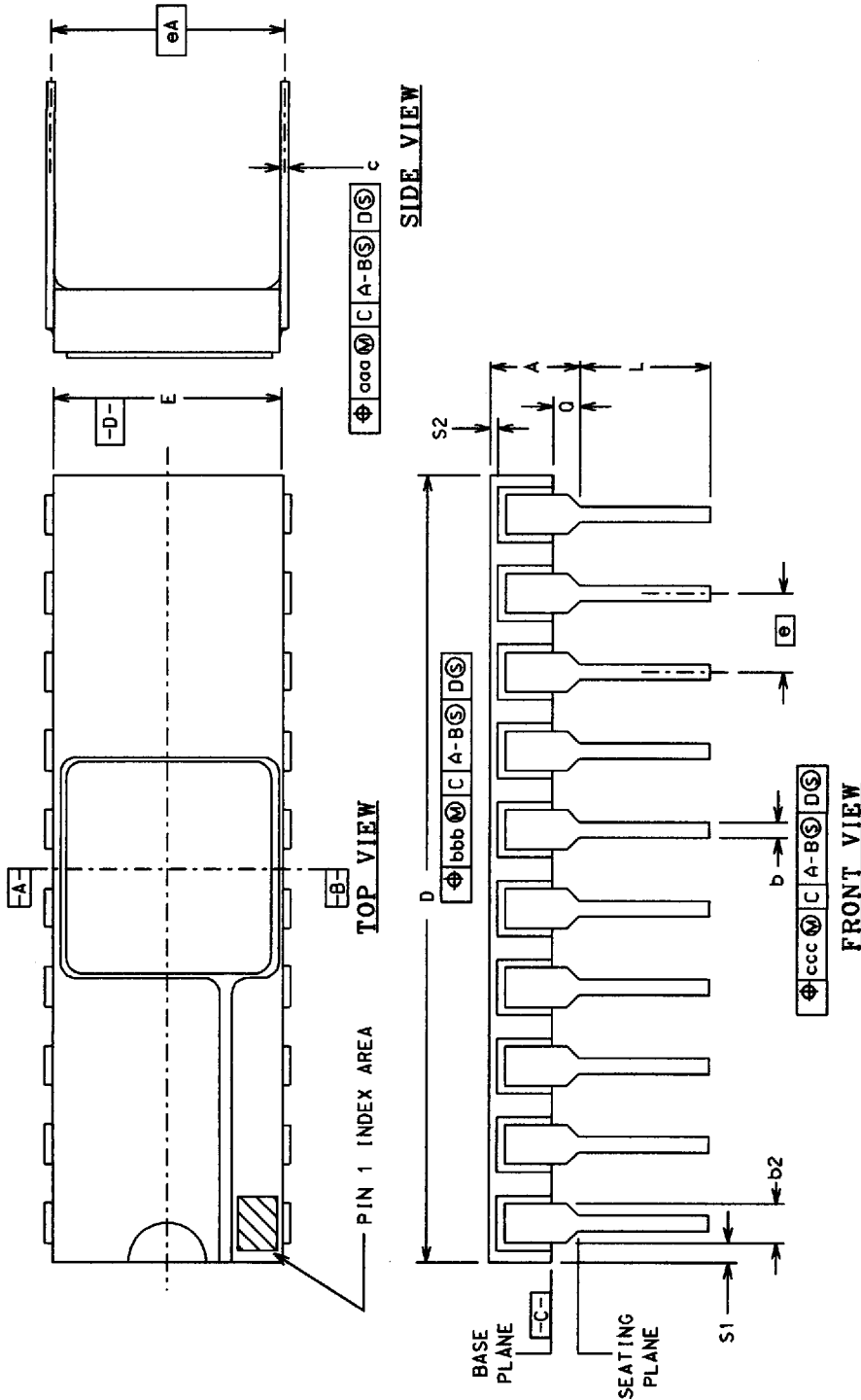

| PKG CONFIG | LEAD COUNT | MIL-STD-1835 DWG CONF C | DIMENSION SYMBOLS |       |       |       |       |       |       |       |       |       |       |       |       |       |       |
|------------|------------|-------------------------|-------------------|-------|-------|-------|-------|-------|-------|-------|-------|-------|-------|-------|-------|-------|-------|
|            |            |                         | A                 | b     | b2    | c     | D     | E     | e     | eA    | L     | O     | S1    | S2    | ccc   | bbb   | ccc   |
| -01        | 14         | D-1                     | 0.200             | 0.026 | 0.065 | 0.018 | 0.785 | 0.310 | 0.100 | 0.300 | 0.200 | 0.060 | ---   | ---   | 0.015 | 0.030 | 0.010 |
| -02        | 16         | D-2                     | 0.200             | 0.014 | 0.045 | 0.008 | ---   | 0.220 | BSC   | BSC   | 0.125 | 0.015 | 0.005 | 0.005 | 0.015 | 0.030 | 0.010 |
| -03        | 20         | D-8                     | 0.200             | 0.026 | 0.065 | 0.018 | 0.840 | 0.310 | 0.100 | 0.300 | 0.200 | 0.060 | ---   | ---   | 0.015 | 0.030 | 0.010 |
|            |            |                         | 0.200             | 0.014 | 0.045 | 0.008 | 1.060 | 0.310 | 0.100 | 0.300 | 0.200 | 0.070 | ---   | ---   | 0.015 | 0.030 | 0.010 |
|            |            |                         | ---               | 0.014 | 0.045 | 0.008 | ---   | 0.220 | BSC   | BSC   | 0.125 | 0.015 | 0.005 | 0.005 | ---   | ---   | ---   |

# Flatpack Packages

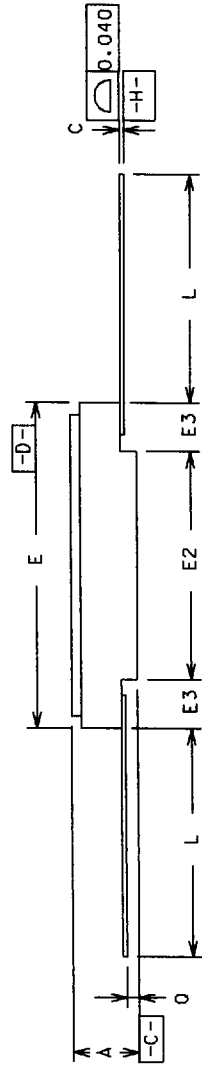
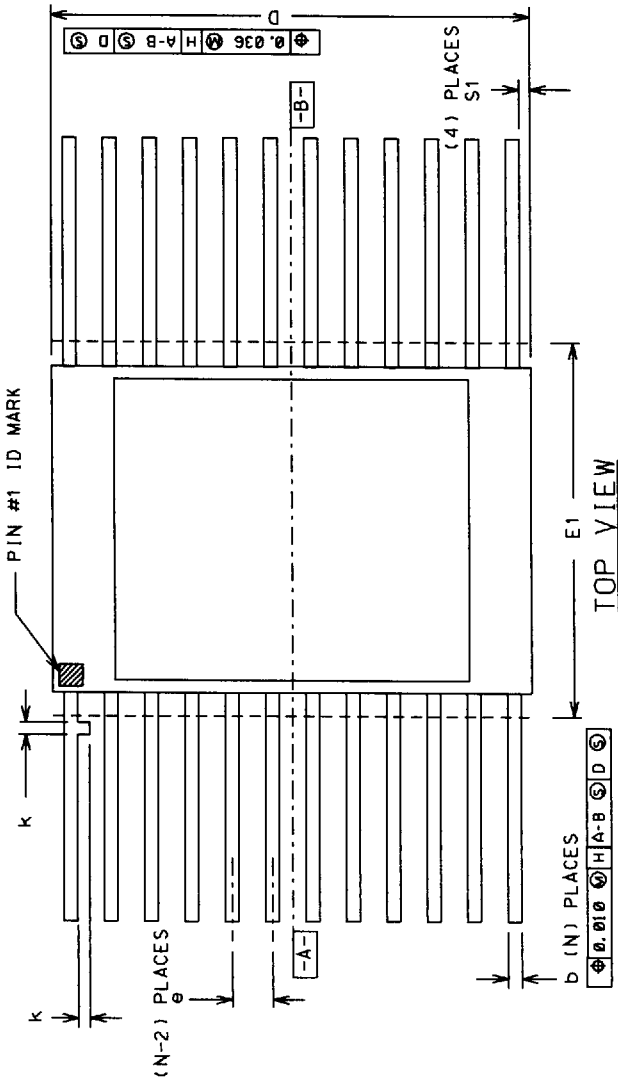

FRONT VIEW

| PKG<br>CONF G | LEAD<br>COUNT | MIL-STD<br>1835 DMG<br>CONF B | DIMENSION SYMBOLS |                |                |              |                |              |              |              |              |                |                |                |     |       |
|---------------|---------------|-------------------------------|-------------------|----------------|----------------|--------------|----------------|--------------|--------------|--------------|--------------|----------------|----------------|----------------|-----|-------|
|               |               |                               | A                 | b              | c              | D            | E              | E1           | E2           | E3           | e            | k              | L              | Q              | S1  |       |
| -03           | 14            | F-2A                          | 0.115<br>0.045    | 0.022<br>0.015 | 0.009<br>0.004 | 0.390<br>--- | 0.260<br>0.235 | 0.290<br>--- | 0.130<br>--- | 0.030<br>--- | 0.050<br>BSC | 0.015<br>0.008 | 0.370<br>0.270 | 0.045<br>0.026 | --- | 0.005 |
| -04           | 16            | F-5A                          | 0.115<br>0.045    | 0.022<br>0.015 | 0.009<br>0.004 | 0.440<br>--- | 0.285<br>0.245 | 0.315<br>--- | 0.130<br>--- | 0.030<br>--- | 0.050<br>BSC | 0.015<br>0.008 | 0.370<br>0.250 | 0.045<br>0.026 | --- | 0.005 |
| -05           | 20            | F-9A                          | 0.115<br>0.045    | 0.022<br>0.015 | 0.009<br>0.004 | 0.540<br>--- | 0.300<br>0.245 | 0.330<br>--- | 0.130<br>--- | 0.030<br>--- | 0.050<br>BSC | 0.015<br>0.008 | 0.370<br>0.250 | 0.045<br>0.026 | --- | 0.000 |