

- Fast Response Times
- High Differential Voltage Amplification
- Low Offset Characteristics
- Outputs Compatible with Most TTL Circuits

**description**

The TL820 is an improved version of the TL720 dual high-speed voltage comparator. Each comparator has differential inputs and a low-impedance output. When compared with the TL720, these circuits feature high amplification (typically 33,000) due to an extra amplification stage and increased accuracy because of lower offset characteristics. They are particularly useful in applications requiring an amplitude discriminator, memory sense amplifier, or a high-speed limit detector.

The TL820M is characterized for operation over the full military temperature range of  $-55^{\circ}\text{C}$  to  $125^{\circ}\text{C}$ ; the TL820C is characterized for operation from  $0^{\circ}\text{C}$  to  $70^{\circ}\text{C}$ .

**symbol (each comparator)**

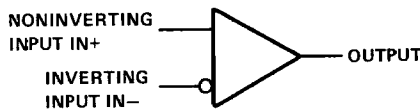

**J OR N DUAL-IN-LINE  
PACKAGE (TOP VIEW)**

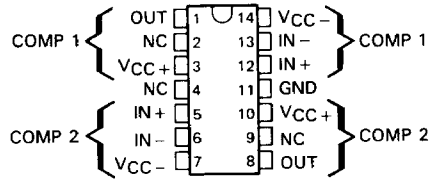

NC—No internal connection

**schematic (each comparator)**

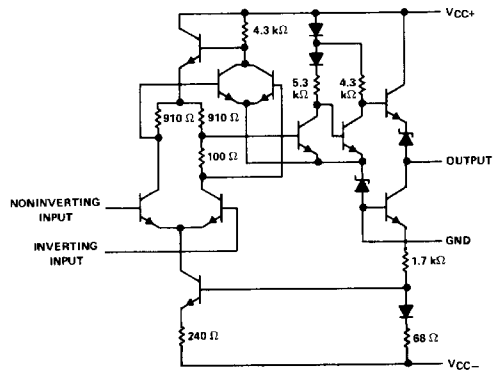

Component values shown are nominal.

**4**

**Voltage Comparators**

**absolute maximum ratings over operating free-air temperature range (unless otherwise noted)**

Supply voltage $V_{CC+}$ (see Note 1) .....	14 V
Supply voltage $V_{CC-}$ (see Note 1) .....	-7 V
Differential input voltage (see Note 2) .....	$\pm 5$ V
Input voltage (any input, see Note 1) .....	$\pm 7$ V
Peak output current ( $t_w \leq 1$ s) .....	10 mA
Continuous total power dissipation at (or below) $70^{\circ}\text{C}$ free-air temperature: each comparator .....	300 mW
total package (see Note 3) ..	600 mW
Operating free-air temperature range: TL820M Circuits .....	$-55^{\circ}\text{C}$ to $125^{\circ}\text{C}$
TL820C Circuits .....	$0^{\circ}\text{C}$ to $70^{\circ}\text{C}$
Storage temperature range .....	$-65^{\circ}\text{C}$ to $150^{\circ}\text{C}$
Lead temperature 1,6 mm (1/16 inch) from case for 60 seconds: J package .....	$300^{\circ}\text{C}$
Lead temperature 1,6 mm (1/16 inch) from case for 10 seconds: N package .....	$260^{\circ}\text{C}$

- NOTES: 1. All voltage values, except differential voltages, are with respect to the network ground terminal.  
 2. Differential voltages are at the noninverting input terminal with respect to the inverting input terminal.  
 3. For operation of the TL820M above  $70^{\circ}\text{C}$  free-air temperature, refer to Dissipation Derating Curves, Section 2. In the J package, TL820M chips are alloy-mounted, TL820C chips are glass-mounted.

# TYPES TL820M, TL820C DUAL DIFFERENTIAL COMPARATORS

electrical characteristics at specified free-air temperature,  $V_{CC+} = 12\text{ V}$ ,  $V_{CC-} = -6\text{ V}$   
(unless otherwise noted)

PARAMETER	TEST CONDITIONS†	TL820M			TL820C			UNIT	
		MIN	TYP	MAX	MIN	TYP	MAX		
$V_{IO}$ Input offset voltage	$R_S < 200\ \Omega$ , See Note 4	25°C	0.6	2	1.6	3.5	mV		
		Full range		3		4.5			
$\alpha V_{IO}$ Average temperature coefficient of input offset voltage	$R_S = 50\ \Omega$ , See Note 4	MIN to 25°C	3	10	3	20	$\mu\text{V}/^\circ\text{C}$		
		25°C to MAX	3	10	3	20			
$I_{IO}$ Input offset current	See Note 4	25°C	0.75	3	1.8	5	$\mu\text{A}$		
		MIN	1.8	7		7.5			
		MAX	0.25	3		7.5			
$\alpha I_{IO}$ Average temperature coefficient of input offset current	See Note 4	MIN to 25°C	15	75	24	100	$\mu\text{A}/^\circ\text{C}$		
		25°C to MAX	5	25	15	50			
$I_{IB}$ Input bias current	See Note 4	25°C	7	15	7	20	$\mu\text{A}$		
		MIN	12	25	9	30			
$V_{ICR}$ Common-mode input voltage range	$V_{CC-} = -7\text{ V}$	Full range	±5		±5		V		
$V_{ID}$ Differential input voltage range		Full range	±5		±5		V		
$A_{VD}$ Large-signal differential voltage amplification	No load, $V_O = 0$ to 2.5 V	25°C	12.5	33	10	33	V/mV		
		Full range	10		8				
$V_{OH}$ High-level output voltage	$V_{ID} = 5\text{ mV}$ , $I_{OH} = 0$	Full range	4§	5	4§	5	V		
	$V_{ID} = 5\text{ mV}$ , $I_{OH} = -5\text{ mA}$	Full range	2.5	3.6§	2.5	3.6§			
$V_{OL}$ Low-level output voltage	$V_{ID} = -5\text{ mV}$ , $I_{OL} = 0$	Full range	-1	-0.5§	0‡	-1	-0.5§	0‡	V
$I_{OL}$ Low-level output current	$V_{ID} = -5\text{ mV}$ , $V_O = 0$	25°C	2	2.4	1.6	2.4	mA		
		MIN	1	2.3	0.5	2.4			
		MAX	0.5	2.3	0.5	2.4			
$r_o$ Output resistance	$V_O = 1.4\text{ V}$	25°C	200		200		$\Omega$		
CMRR Common-mode rejection ratio	$R_S < 200\ \Omega$	Full range	80	100§	70	100§	dB		
$I_{CC+}$ Supply current from $V_{CC+}$ (each comparator)	$V_{ID} = -5\text{ mV}$ , No load	Full range	5.5§	9	5.5§	9	mA		
$I_{CC-}$ Supply current from $V_{CC-}$ (each comparator)		Full range	-3.5§	-7	-3.5§	-7	mA		
$P_D$ Total power dissipation (each comparator)		Full range	90§	150	90§	150	mW		

† Full range (MIN to MAX) for TL820M is  $-55^\circ\text{C}$  to  $125^\circ\text{C}$  and for the TL820C is  $0^\circ\text{C}$  to  $70^\circ\text{C}$ .

‡ The algebraic convention where the most-positive (least-negative) limit is designated as maximum is used in this data sheet for logic levels only, e.g., when 0 V is the maximum, the minimum limit is a more-negative voltage.

§ These typical values are at  $T_A = 25^\circ\text{C}$ .

NOTE 4: These characteristics are verified by measurements at the following temperatures and output voltage levels: for TL820M,  $V_O = 1.8\text{ V}$  at  $T_A = -55^\circ\text{C}$ ,  $V_O = 1.4\text{ V}$  at  $T_A = 25^\circ\text{C}$ , and  $V_O = 1\text{ V}$  at  $T_A = 125^\circ\text{C}$ ; for TL820C,  $V_O = 1.5\text{ V}$  at  $T_A = 0^\circ\text{C}$ ,  $V_O = 1.4\text{ V}$  at  $25^\circ\text{C}$ , and  $V_O = 1.2\text{ V}$  at  $T_A = 70^\circ\text{C}$ . These output voltage levels were selected to approximate the logic threshold voltages of the types of digital logic circuits these comparators are intended to drive.

## switching characteristics, $V_{CC+} = 12\text{ V}$ , $V_{CC-} = -6\text{ V}$ , $T_A = 25^\circ\text{C}$

PARAMETER	TEST CONDITIONS	MIN	TYP	MAX	UNIT
Response time	$R_L = \infty$ , $C_L = 5\text{ pF}$ , See Note 5		30	80	ns

NOTE 5: The response time specified is for a 100-mV input step with 5-mV overdrive and is the interval between the input step function and the instant when the output crosses 1.4 V.

4

Voltage Comparators

**TYPICAL CHARACTERISTICS**

**LARGE-SIGNAL DIFFERENTIAL VOLTAGE AMPLIFICATION**

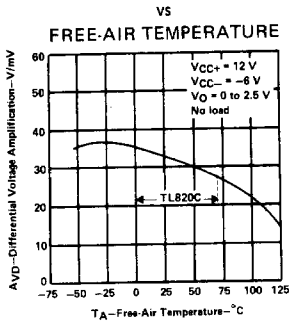

**FIGURE 1**

**LARGE-SIGNAL DIFFERENTIAL VOLTAGE AMPLIFICATION**

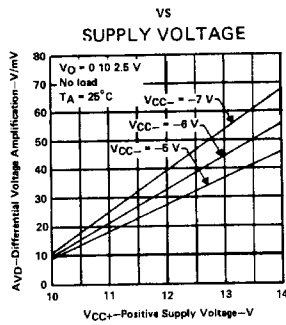

**FIGURE 2**

**OUTPUT VOLTAGE LEVELS**

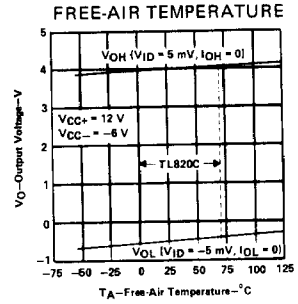

**FIGURE 3**

**LOW-LEVEL OUTPUT CURRENT**

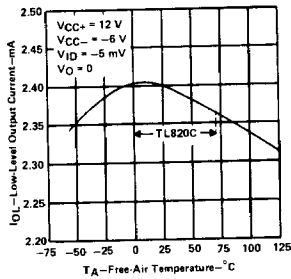

**FIGURE 4**

**TL820M  
VOLTAGE TRANSFER CHARACTERISTICS**

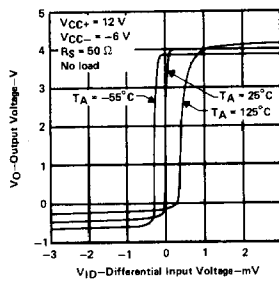

**FIGURE 5**

**TL820C  
VOLTAGE TRANSFER CHARACTERISTICS**

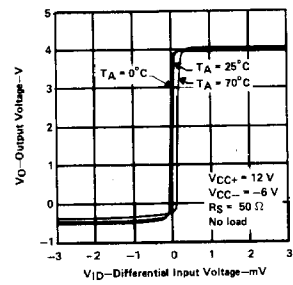

**FIGURE 6**

**4**

**Voltage Comparators**

# TYPES TL820M, TL820C DUAL DIFFERENTIAL COMPARATORS

## TYPICAL CHARACTERISTICS

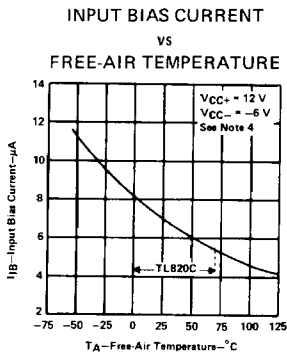

FIGURE 7

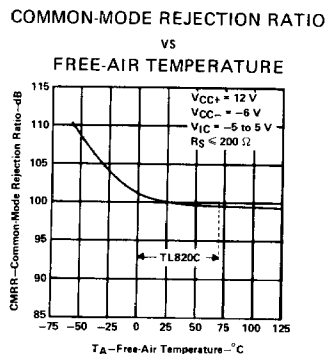

FIGURE 8

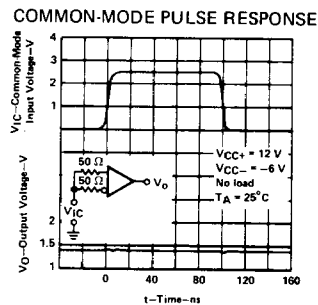

FIGURE 9

4

Voltage Comparators

### OUTPUT RESPONSE FOR VARIOUS INPUT OVERDRIVES

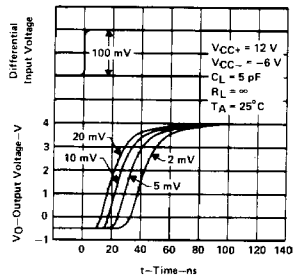

FIGURE 10

### TOTAL POWER DISSIPATION VS FREE-AIR TEMPERATURE

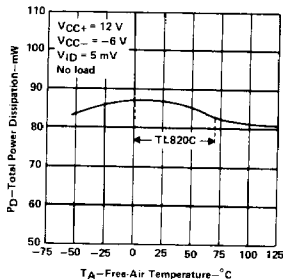

FIGURE 11

NOTE 4: These characteristics are verified by measurements at the following temperatures and output voltage levels: for TL820M,  $V_O = 1.8$  V at  $T_A = -55^\circ\text{C}$ ,  $V_O = 1.4$  V at  $T_A = 25^\circ\text{C}$ , and  $V_O = 1$  V at  $T_A = 125^\circ\text{C}$ ; for TL820C,  $V_O = 1.5$  V at  $T_A = 0^\circ\text{C}$ ,  $V_O = 1.4$  V at  $25^\circ\text{C}$ , and  $V_O = 1.2$  V at  $T_A = 70^\circ\text{C}$ . These output voltage levels were selected to approximate the logic threshold voltages of the types of digital logic circuits these comparators are intended to drive.