

National Semiconductor is now part of
Texas Instruments.

Search <http://www.ti.com/> for the latest technical
information and details on our current products and services.

LM4865 Boomer® Audio Power Amplifier Series

750 mW Audio Power Amplifier with DC Volume Control and Headphone Switch

General Description

The LM4865 is a mono bridged audio power amplifier with DC voltage volume control. The LM4865 is capable of delivering 750mW of continuous average power into an 8Ω load with less than 1% THD when powered by a 5V power supply. Switching between bridged speaker mode and headphone (single ended) mode is accomplished using the headphone sense pin. To conserve power in portable applications, the LM4865's micropower shutdown mode ($I_Q = 0.7\mu A$, typ) is activated when less than 300mV is applied to the DC Vol/SD pin.

Boomer audio power amplifiers are designed specifically to provide high power audio output while maintaining high fidelity. They require few external components and operate on low supply voltages.

Applications

- GSM phones and accessories, DECT, office phones
- Hand held radio

- Other portable audio devices

Key Specifications

■ P_O at 1.0% THD+N into 8Ω SO, micro SMD	750mW (typ)
■ P_O at 10% THD+N into 8Ω SO, micro SMD	1W (typ)
■ Shutdown current	0.7μA(typ)
■ Supply voltage range	2.7V to 5.5V

Features

- DC voltage volume control
- Headphone amplifier mode
- "Click and pop" suppression
- Shutdown control when volume control pin is low
- Thermal shutdown protection

Connection Diagrams

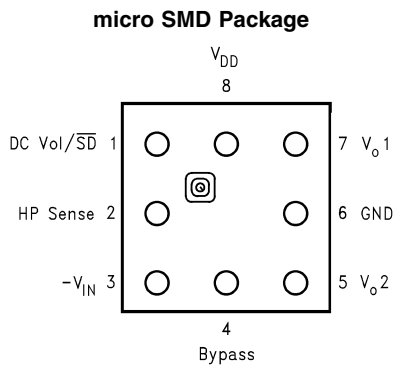

Top View
Order Number LM4865IBP
See NS Package Number BPA08CFB

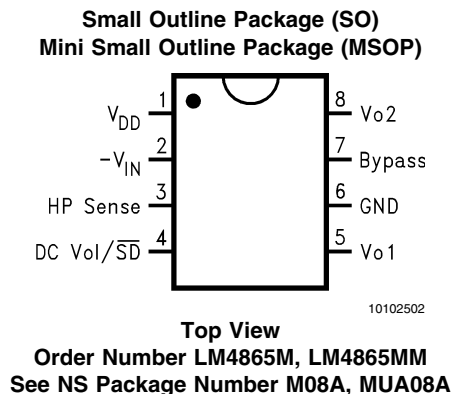

BOOMER™ is a trademark of National Semiconductor Corporation.

Typical Application

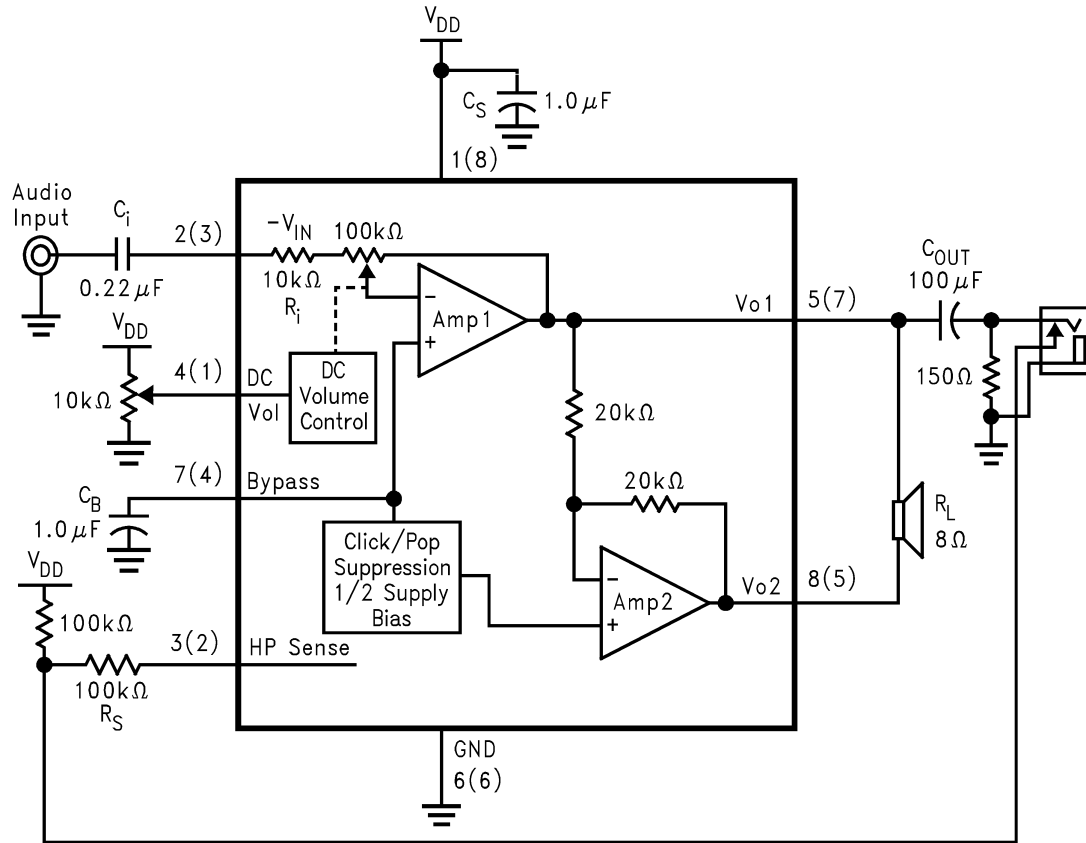

10102501

FIGURE 1. Typical Audio Amplifier Application Circuit
 (Numbers in () are specific to the micro SMD package)

Absolute Maximum Ratings (Note 2)

If Military/Aerospace specified devices are required, please contact the National Semiconductor Sales Office/Distributors for availability and specifications.

Supply Voltage	6.0V
Storage Temperature	-65°C to +150°C
Input Voltage	-0.3V to V_{DD} +0.3V
Power Dissipation (Note 3)	Internally Limited
ESD Susceptibility (Note 4)	2000V
ESD Susceptibility (Note 5)	200V
Junction Temperature	150°C
Soldering Information	
Vapor Phase (60 sec.)	215°C
Infrared (15 sec.)	220°C

Thermal Resistance

θ_{JC} (SOP)	35°C/W
θ_{JA} (SOP)	150°C/W
θ_{JC} (MSOP)	56°C/W
θ_{JA} (MSOP)	190°C/W
θ_{JA} (micro SMD)	150°C/W

Operating Ratings

Temperature Range

$$T_{MIN} \leq T_A \leq T_{MAX} \quad -40^\circ\text{C} \leq T_A \leq +85^\circ\text{C}$$

Supply Voltage

$$2.7\text{V} \leq V_{DD} \leq 5.5\text{V}$$

See AN-450 "Surface Mounting and their Effects on Product Reliability" for other methods of soldering surface mount devices.

Electrical Characteristics (Notes 1, 2)

The following specifications apply for $V_{DD} = 5\text{V}$, unless otherwise specified. Limits apply for $T_A = 25^\circ\text{C}$.

Symbol	Parameter	Conditions	LM4865			Units
			Min (Note 7)	Typical (Note 6)	Max (Note 7)	
V_{DD}	Supply Voltage		2.7		5.5	V
I_{DD}	Quiescent Power Supply Current	$V_{IN} = 0\text{V}$, $I_O = 0\text{A}$, HP Sense = 0V		4	7	mA
		$V_{IN} = 0\text{V}$, $I_O = 0\text{A}$, HP Sense = 5V		3.5	6	mA
I_{SD}	Shutdown Current	$V_{PIN4} \leq 0.3\text{V}$		0.7		μA
V_{OS}	Output Offset Voltage	$V_{IN} = 0\text{V}$		5	50	mV
P_O	Output Power	THD = 1% (max), HP Sense < 0.8V, $f = 1\text{kHz}$, $R_L = 8\Omega$	500	750		mW
		THD = 10% (max), HP Sense < 0.8V, $f = 1\text{kHz}$, $R_L = 8\Omega$		1.0		W
		THD + N = 1%, HP Sense > 4V, $f = 1\text{kHz}$, $R_L = 32\Omega$		80		mW
		THD = 10%, HP Sense > 4V, $f = 1\text{kHz}$, $R_L = 32\Omega$		110		mW
THD+N	Total Harmonic Distortion + Noise	$P_O = 300\text{mWrms}$, $f = 20\text{Hz} - 20\text{kHz}$, $R_L = 8\Omega$		0.6		%
PSRR	Power Supply Rejection Ratio	$V_{RIPPLE} = 200\text{mVrms}$, $R_L = 8\Omega$, $C_B = 1.0\mu\text{F}$, $f = 1\text{kHz}$		50		dB
Gain _{RANGE}	Single-Ended Gain Range	Gain with $V_{PIN4} \geq 4.0\text{V}$, (80% of V_{DD})	18.8	20		dB
		Gain with $V_{PIN4} \leq 0.9\text{V}$, (18% of V_{DD})	-70	-72		dB
V_{IH}	HP Sense High Input Voltage		4			V
V_{IL}	HP Sense Low Input Voltage				0.8	V

Note 1: All voltages are measured with respect to the ground pin, unless otherwise specified.

Note 2: "Absolute Maximum Ratings" indicate limits beyond which damage to the device may occur. "Operating Ratings" indicate conditions for which the device is functional, but do not guarantee specific performance limits. "Electrical Characteristics" state DC and AC electrical specifications under particular test conditions that guarantee specific performance limits. This assumes that the device operates within the Operating Ratings. Specifications are not guaranteed for parameters where no limit is given. The typical value, however, is a good indication of device performance.

Note 3: The maximum power dissipation must be derated at elevated temperatures and is dictated by T_{JMAX} , θ_{JA} , and the ambient temperature T_A . The maximum allowable power dissipation is $P_{DMAX} = (T_{JMAX} - T_A)/\theta_{JA}$ or the number given in the Absolute Maximum Ratings, whichever is lower. For the LM4865M, $T_{JMAX} = 150^\circ\text{C}$.

Note 4: Human body model, 100pF discharged through a 1.5k Ω resistor.

Note 5: Machine Model, 220pF–240pF discharged through all pins.

Note 6: Typicals are measured at 25°C and represent the parametric norm.

Note 7: Limits are guaranteed to National's AOQL (Average Outgoing Quality Level).

Note 8: The quiescent power supply current depends on the offset voltage when a practical load is connected to the amplifier.

External Components Description

(Figure 1)

Components	Functional Description
1. C_i	Input coupling capacitor which blocks the DC voltage at the amplifier's input terminals. It also creates a highpass filter with the internal R_i . The designer should note that $10k\Omega < (R_i) < 110k\Omega$. Therefore $f_c = 1/(2\pi R_i C_i)$. Refer to the section, Proper Selection of External Components , for an explanation of how to determine the value of C_i .
2. C_S	Supply bypass capacitor which provides power supply filtering. Refer to the Power Supply Bypassing section for information concerning proper placement and selection of the supply bypass capacitor.
3. C_B	Bypass pin capacitor which provides half-supply filtering. Refer to the section, Proper Selection of External Components , for information concerning proper placement and selection of C_B .

Typical Performance Characteristics

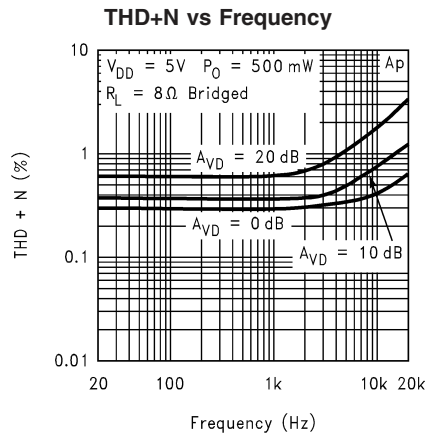

10102505

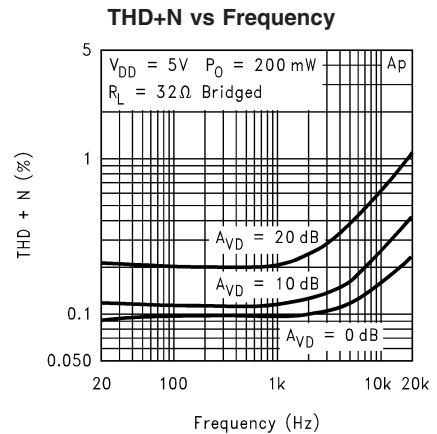

10102506

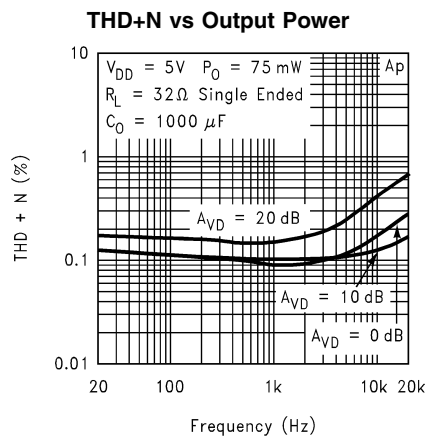

10102507

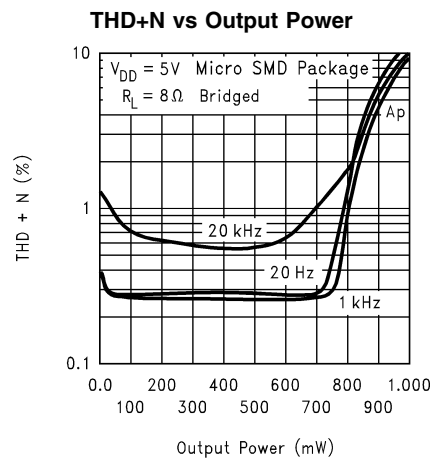

10102508

Typical Performance Characteristics (Continued)

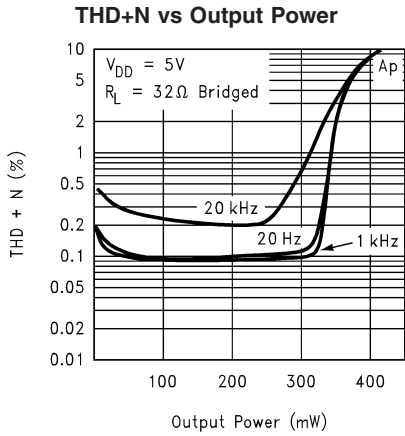

10102510

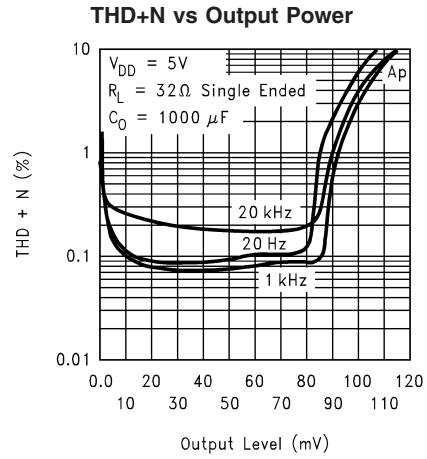

10102511

Power Dissipation vs Load Resistance

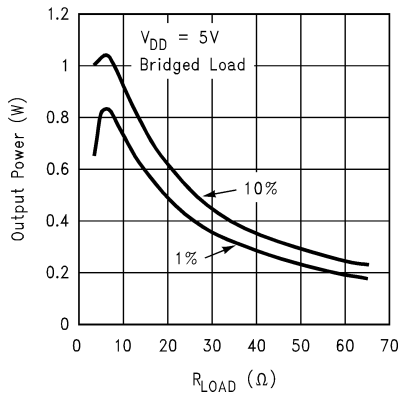

10102512

Power Dissipation vs Output Power

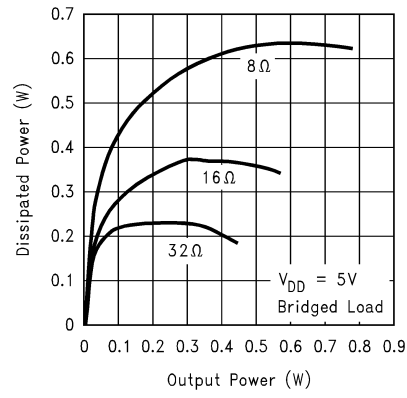

10102513

Power Derating Curve

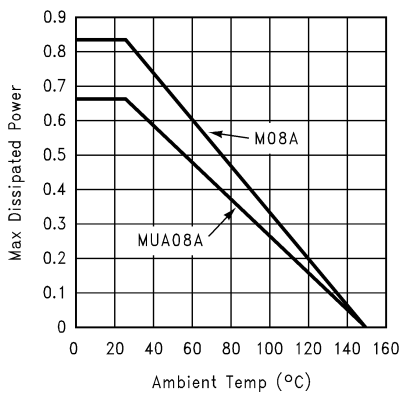

10102514

Clipping Voltage vs RL

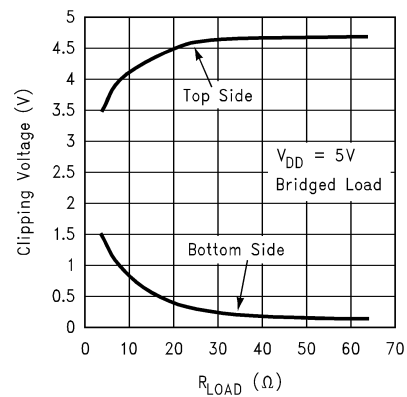

10102515

Typical Performance Characteristics (Continued)

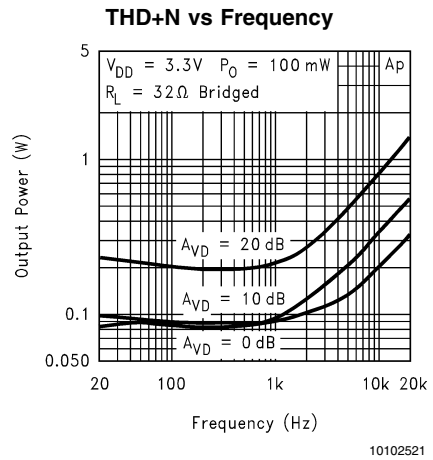
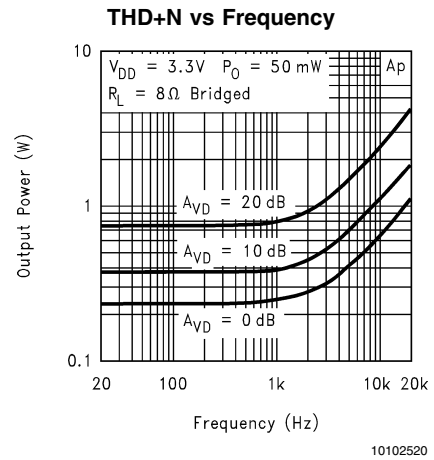
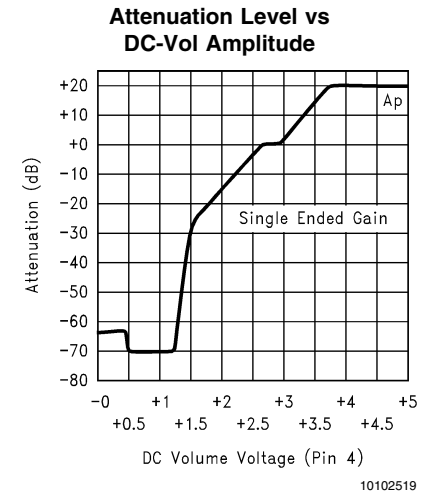
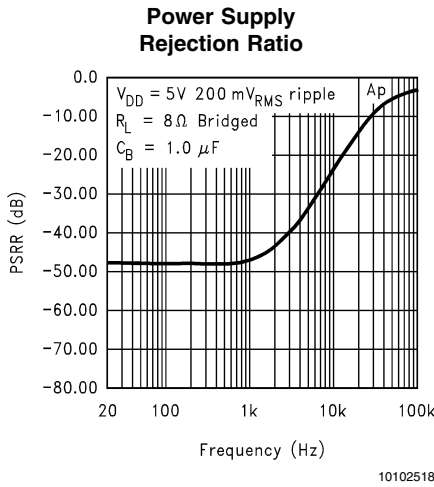
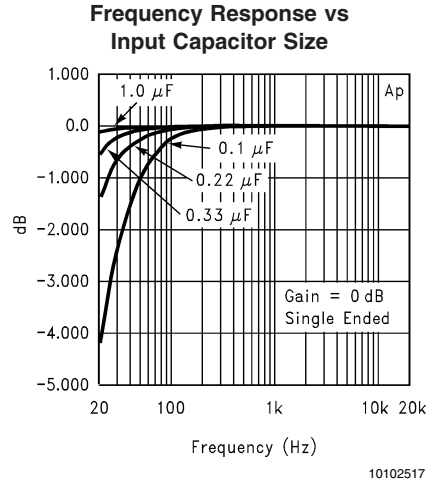
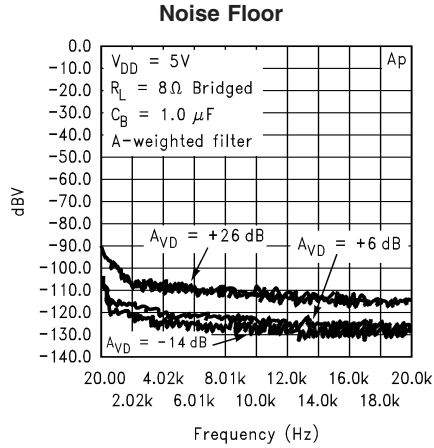

Typical Performance Characteristics (Continued)

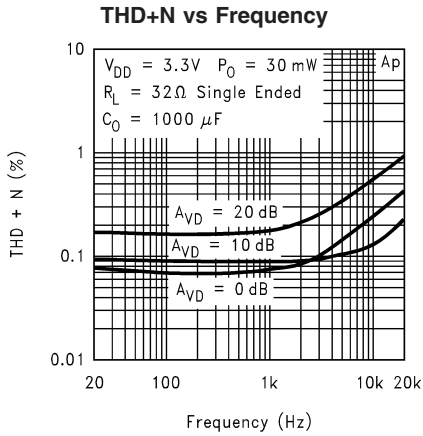

10102522

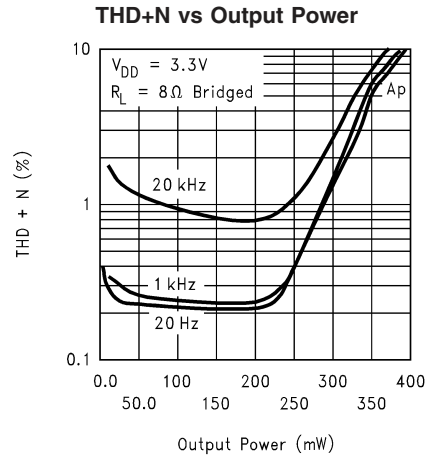

10102523

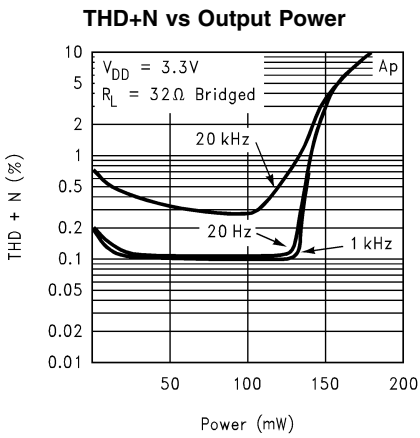

10102524

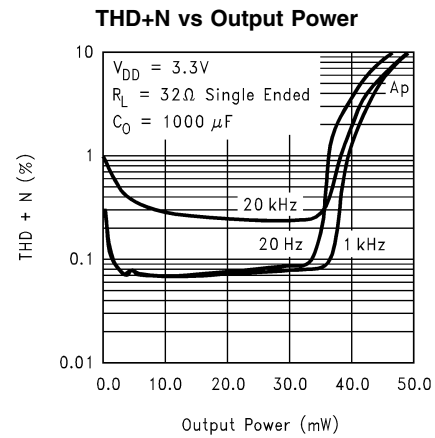

10102528

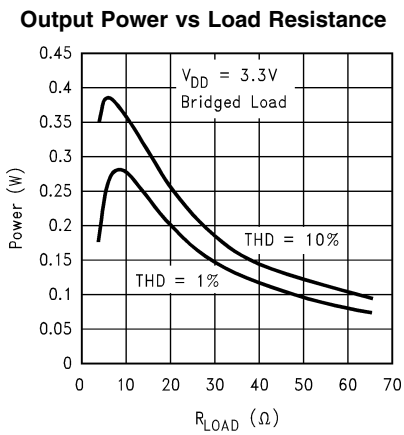

10102529

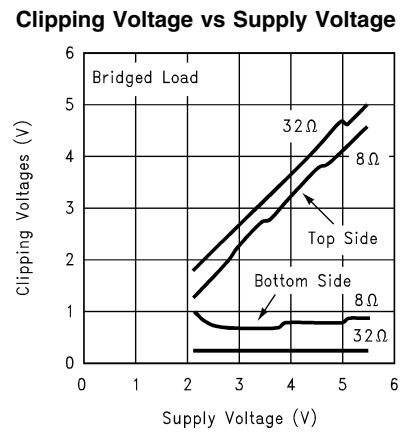

10102530

Typical Performance Characteristics (Continued)

Output Power vs Supply Voltage

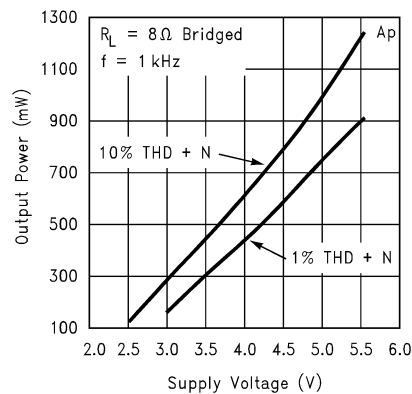

10102531

Output Power vs Supply Voltage

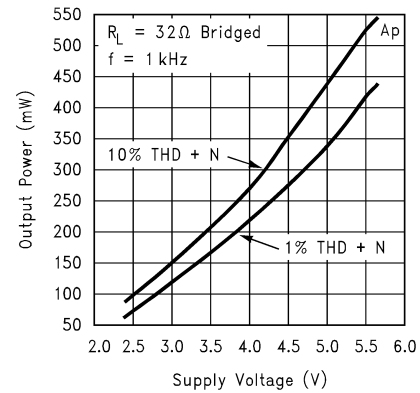

10102532

Supply Current vs Supply Voltage

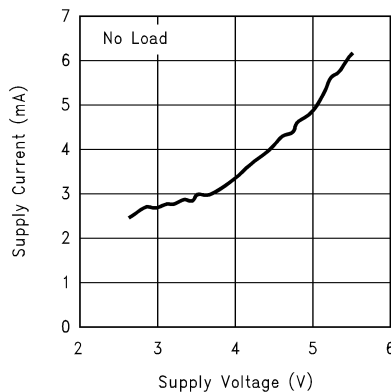

10102533

Application Information

BRIDGE CONFIGURATION EXPLANATION

As shown in *Figure 1*, the LM4865 consists of two operational amplifiers internally. An external DC voltage sets the closed-loop gain of the first amplifier, whereas two internal $20\text{k}\Omega$ resistors set the second amplifier's gain at -1 . The LM4865 can be used to drive a speaker connected between the two amplifier outputs or a monaural headphone connected between V_{O1} and GND.

Figure 1 shows that the output of Amp1 serves as the input to Amp2. This results in both amplifiers producing signals that are identical in magnitude, but 180° out of phase.

Taking advantage of this phase difference, a load placed between V_{O1} and V_{O2} is driven differentially (commonly referred to as "bridge mode"). This mode is different from single-ended driven loads that are connected between a single amplifier's output and ground.

Bridge mode has a distinct advantage over the single-ended configuration: its differential drive to the load doubles the output swing for a specified supply voltage. This results in four times the output power when compared to a single-ended amplifier under the same conditions. This increase in attainable output assumes that the amplifier is not current limited or the output signal is not clipped. To ensure

minimum output signal clipping when choosing an amplifier's closed-loop gain, refer to the **Audio Power Amplifier Design** section.

Another advantage of the differential bridge output is no net DC voltage across load. This results from biasing V_{O1} and V_{O2} at half-supply. This eliminates the coupling capacitor that single supply, single-ended amplifiers require. Eliminating an output coupling capacitor in a single-ended configuration forces a single supply amplifier's half-supply bias voltage across the load. The current flow created by the half-supply bias voltage increases internal IC power dissipation and may permanently damage loads such as speakers.

POWER DISSIPATION

Power dissipation is a major concern when designing a successful bridged or single-ended amplifier. Equation (1) states the maximum power dissipation point for a single-ended amplifier operating at a given supply voltage and driving a specified output load.

$$P_{\text{DMAX}} = (V_{\text{DD}})^2 / (2\pi^2 R_L) \quad \text{Single-Ended} \quad (1)$$

However, a direct consequence of the increased power delivered to the load by a bridge amplifier is an increase in internal power dissipation point for a bridge amplifier operating at the same given conditions.

$$P_{\text{DMAX}} = 4 * (V_{\text{DD}})^2 / (2\pi^2 R_L) \quad \text{Bridge Mode} \quad (2)$$

The LM4865 has two operational amplifiers in one package and the maximum internal power dissipation is 4 times that

Application Information (Continued)

of a single-ended amplifier. However, even with this substantial increase in power dissipation, the LM4865 does not require heatsinking. From Equation (2), assuming a 5V power supply and an 8Ω load, the maximum power dissipation point is 633 mW. The maximum power dissipation point obtained from Equation (2) must not be greater than the power dissipation that results from Equation (3):

$$P_{\text{DMAX}} = (T_{\text{JMAX}} - T_{\text{A}}) / \theta_{\text{JA}} \quad (3)$$

For the micro SMD and SO packages, $\theta_{\text{JA}} = 150^{\circ}\text{C}/\text{W}$. The MSO package has a $190^{\circ}\text{C}/\text{W}$ θ_{JA} . $T_{\text{JMAX}} = 150^{\circ}\text{C}$ for the LM4865. For a given ambient temperature T_{A} , Equation (3) can be used to find the maximum internal power dissipation supported by the IC packaging. If the result of Equation (2) is greater than that of Equation (3), then either decrease the supply voltage, increase the load impedance, or reduce the ambient temperature. For a typical application using the micro SMD or SO packaged LM4865, a 5V power supply, and an 8Ω load, the maximum ambient temperature that does not violate the maximum junction temperature is approximately 55°C. The maximum ambient temperature for the MSO package with the same conditions is approximately 30°C. These results further assume that a device is a surface mount part operating around the maximum power dissipation point. Since internal power dissipation is a function of output power, higher ambient temperatures are allowed as output power decreases. Refer to the **Typical Performance Characteristics** curves for power dissipation information at lower output power levels.

POWER SUPPLY BYPASSING

As with any power amplifier, proper supply bypassing is critical for low noise performance and high power supply rejection. The capacitors connected to the bypass and power supply pins should be placed as close to the LM4865 as possible. The capacitor connected between the bypass pin and ground improves the internal bias voltage's stability, producing improved PSRR. The improvements to PSRR increase as the bypass pin capacitor value increases. Typical applications employ a 5V regulator with 10μF and a 0.1μF filter capacitors that aid in supply stability. Their presence, however does not eliminate the need for bypassing the supply nodes of the LM4865. The selection of bypass capacitor values, especially C_{B} , depends on desired PSRR requirements, click and pop performance (as explained in the section, **Proper Selection of External Components**), system cost, and size constraints.

DC VOLTAGE VOLUME CONTROL

The LM4865 has internal volume control that is controlled by the DC voltage applied its DC Vol/SD pin (pin 5 on the micro SMD and pin 4 on the MSOP and SOP packages). The volume control's input range is from GND to V_{DD} . A graph showing a typical volume response versus input control voltage is shown in the **Typical Performance Characteristics** section. The DC Vol/SD pin also functions as the control pin for the LM4865's micropower shutdown feature. See the **Shutdown Function** section for more information.

Like all volume controls, the LM4865's internal volume control is set while listening to an amplified signal that is applied to an external speaker. The actual voltage applied to the DC Vol/SD pin is a result of the volume a listener desires. As such, the volume control is designed for use in a feedback system that includes human ears and preferences. This feedback system operates quite well without the need for

accurate gain. The user simply sets the volume to the desired level as determined by their ear, without regard to the actual DC voltage that produces the volume. Therefore, the accuracy of the volume control is not critical, as long as volume changes monotonically and step size is small enough to reach a desired volume that is not too loud or too soft. Since gain accuracy is not critical, there will be volume variation from part-to-part even with the same applied DC control voltage. The gain of a given LM4865 may be set with a fixed external voltage, but another LM4865 may require a different control voltage to achieve the same gain. *Figure 2* is a curve showing the volume variation of twenty typical LM4865s as the voltage applied to the DC Vol/SD pin is varied. For gains greater than unity, the typical part-to-part variation can be as large as 8dB for the same control voltage.

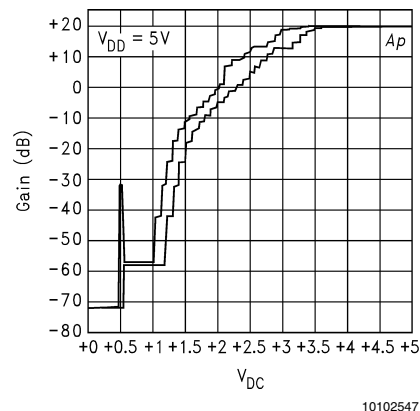

FIGURE 2. Typical part-to-part gain variation as a function of DC-Vol control voltage

MUTE AND SHUTDOWN FUNCTION

The LM4865's mute and shutdown functions are controlled through the DC Vol/SD pin. Mute is activated by applying a voltage in the range of 500mV to 1V. A typical attenuation of 75dB is achieved while mute is active. The LM4865's micropower shutdown mode turns off the amplifier's bias circuitry. The micropower shutdown mode is activated by applying less than 300mV_{DC} to the DC Vol/SD pin. When shutdown is active, the supply current is reduced to 0.7μA (typ). A degree of uncertainty exists when the voltage applied to the DC Vol/SD pin is in the range of 300mV to 500mV. The LM4865 can be in mute, still fully powered, or in micropower shutdown and fully muted. In mute mode, the LM4865 draws the typical quiescent supply current. The DC Vol/SD pin should be tied to GND for best shutdown mode performance. As the DC Vol/SD is increased above 0.5V the amplifier will follow the attenuation curve in **Typical Performance Characteristics**.

HP-Sense FUNCTION

Applying a voltage between 4V and V_{CC} to the LM4865's HP-Sense headphone control pin turns off Amp2 and mutes a bridged-connected load. Quiescent current consumption is reduced when the IC is in this single-ended mode.

Figure 3 shows the implementation of the LM4865's headphone control function. With no headphones connected to the headphone jack, the R1-R2 voltage divider sets the

Application Information (Continued)

voltage applied to the HP-Sense pin (pin 3) at approximately 50mV. This 50mV enables the LM4865 and places it in bridged mode operation.

While the LM4865 operates in bridged mode, the DC potential across the load is essentially 0V. Since the HP-Sense threshold is set at 4V, even in an ideal situation, the output swing cannot cause a false single-ended trigger. Connecting headphones to the headphone jack disconnects the headphone jack contact pin from V_{O1} and allows R1 to pull the HP Sense pin up to V_{CC} . This enables the headphone function, turns off Amp2, and mutes the bridged speaker. The amplifier then drives the headphones, whose impedance is in parallel with resistor R2. Resistor R2 has negligible effect on output drive capability since the typical impedance of headphones is 32Ω. The output coupling capacitor blocks the amplifier's half supply DC voltage, protecting the headphones.

A microprocessor or a switch can replace the headphone jack contact pin. When a microprocessor or switch applies a voltage greater than 4V to the HP Sense pin, a bridge-connected speaker is muted and Amp1 drives the headphones.

PROPERLY SELECTING EXTERNAL COMPONENTS

Optimizing the LM4865's performance requires properly selecting external components. Though the LM4865 operates well when using external components having wide tolerances, the best performance is achieved by optimizing component values.

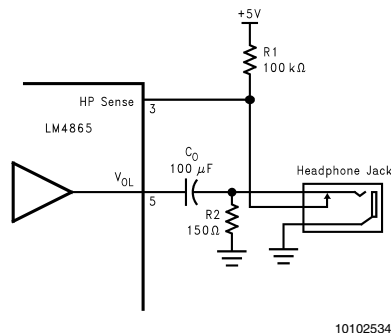

FIGURE 3. Headphone Circuit

Input Capacitor Value Selection

Amplification of the lowest audio frequencies requires high value input coupling capacitors. These high value capacitors can be expensive and may compromise space efficiency in portable designs. In many cases, however, the speakers used in portable systems, whether internal or external, have little ability to reproduce signals below 150Hz. In application 5 using speakers with this limited frequency response, a large input capacitor will offer little improvement in system performance.

Figure 1 shows that the nominal input impedance (R_{IN}) is 10kΩ at maximum volume and 110kΩ at minimum volume. Together, the input capacitor, C_i , and R_{IN} , produce a -3dB high pass filter cutoff frequency that is found using Equation (4).

$$f_{-3\text{dB}} = \frac{1}{2\pi R_{IN} C_i} \quad (4)$$

As the volume changes from minimum to maximum, R_{IN} decrease from 110kΩ to 10kΩ. Equation (4) reveals that the -3dB frequency will increase as the volume increases. The nominal value of C_i for lowest desired frequency response should be calculated with $R_{IN} = 10\text{k}\Omega$. As an example when using a speaker with a low frequency limit of 150Hz, C_i , using Equation (4) is 0.1μF. The 0.22μF C_i shown in Figure 1 is optimized for a speaker whose response extends down to 75Hz.

Bypass Capacitor Value Selection

Besides minimizing the input capacitor size, careful consideration should be paid to value of the bypass capacitor C_B . Since C_B determines how fast the LM4865 turns on, its value is the most critical when minimizing turn-on pops. The slower the LM4865's outputs ramp to their quiescent DC voltage (nominally $V_{DD}/2$), the smaller the turn-on pop. Choosing C_B equal to 1.0μF, along with a small value of C_i (in the range of 0.1μF to 0.39μF), produces a clickless and popless shutdown function. Choosing C_i as small as possible helps minimize clicks and pops.

CLICK AND POP CIRCUITRY

The LM4865 contains circuitry that minimizes turn-on and shutdown transients or 'clicks and pops'. For this discussion, turn-on refers to either applying the power supply voltage or when the shutdown mode is deactivated. While the power supply is ramping to its final value, the LM4865's internal amplifiers are configured as unity gain buffers. An internal current source changes the voltage of the bypass pin in a controlled, linear manner. Ideally, the input and outputs track the voltage applied to the bypass pin. The gain of the internal amplifiers remains unity until the voltage on the bypass pin reaches 1/2 V_{DD} . As soon as the voltage on the bypass pin is stable, the device becomes fully operational and the gain is set by the external voltage applied to the DC Vol/SD pin.

Although the bypass pin current cannot be modified, changing the size of C_B alters the device's turn-on time and the magnitude of 'clicks and pops'. Increasing the value of C_B reduces the magnitude of turn-on pops. However, this presents a tradeoff: as the size of C_B increases, the turn-on time increases. There is a linear relationship between the size of C_B and the turn-on time. Shown below are some typical turn-on times for various values of C_B :

C_B	T_{ON}
0.01μF	20ms
0.1μF	200ms
0.22μF	420ms
0.47μF	840ms
1.0μF	2sec

In order eliminate 'clicks and pops', all capacitors must be discharged before turn-on. Rapidly switching V_{DD} may not allow the capacitors to fully discharge, which may cause 'clicks and pops'. In a single-ended configuration, the output coupling capacitor, C_{OUT} , is of particular concern. This capacitor discharges through an internal 20kΩ resistor. Depending on the size of C_{OUT} , the time constant can be relatively large. To reduce transients in single-ended mode,

Application Information (Continued)

an external 1kΩ - 5kΩ resistor can be placed in parallel with the internal 20kΩ resistor. The tradeoff for using this resistor is increased quiescent current.

RECOMMENDED PRINTED CIRCUIT BOARD LAYOUT

Figure 4 through Figure 6 show the recommended two-layer PC board layout that is optimized for the SO-8 packaged LM4865 and associated external components. Figure 7 through Figure 11 show the recommended four-layer PC board layout for the micro SMD packaged LM4865. A four-layer board is recommended when using the micro SMD packaged LM4865: the two inner layers, one connected to the GND pin, the other to the V_{DD} pin, provide heatsinking. Both layouts are designed for use with an external 5V supply, 8Ω speakers, and 32Ω headphones. The schematic for both recommended PC board layouts is Figure 1.

Both circuit boards are easy to use. Apply a 5V supply voltage and ground to the board's V_{DD} and GND pads, respectively. Connect a speaker with an 8Ω minimum impedance between the board's -OUT and +OUT pads. For headphone use, the layout has provisions for a headphone jack, J1. When a jack is connected as shown, inserting a headphone plug automatically switches off the external speaker.

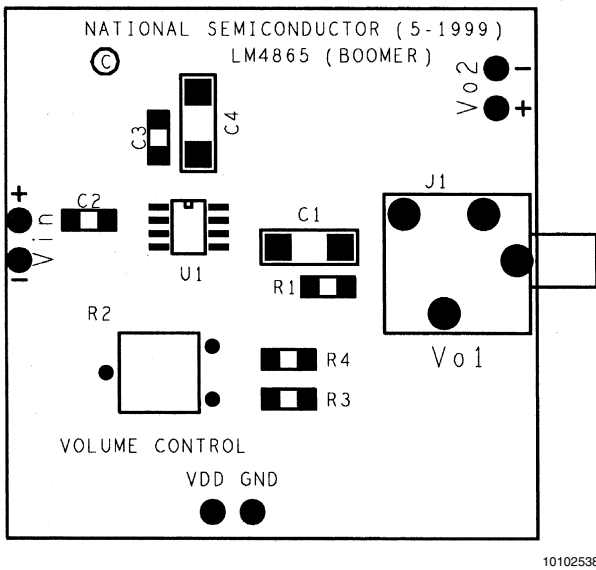
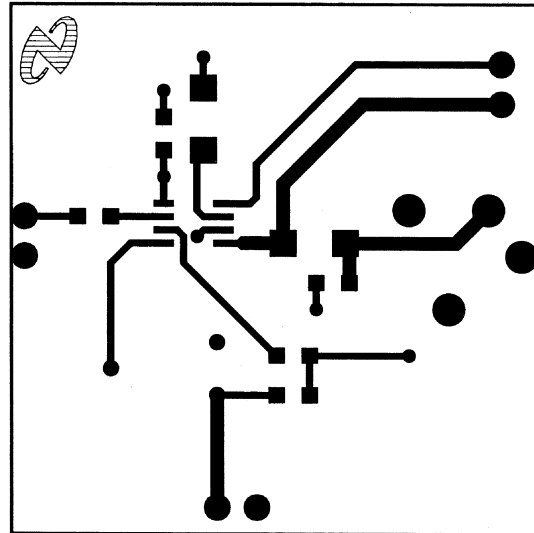
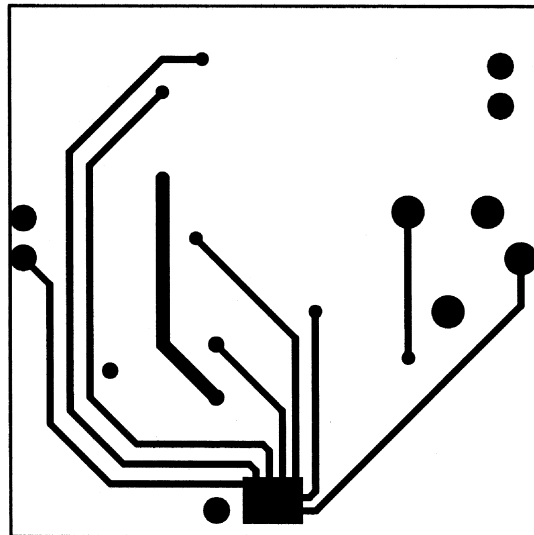

FIGURE 4. Recommended SO PC board layout: component side silkscreen



10102539

FIGURE 5. Recommended SO PC board layout: component side layout



10102540

FIGURE 6. Recommended SO PC board layout: bottom side layout

Application Information (Continued)

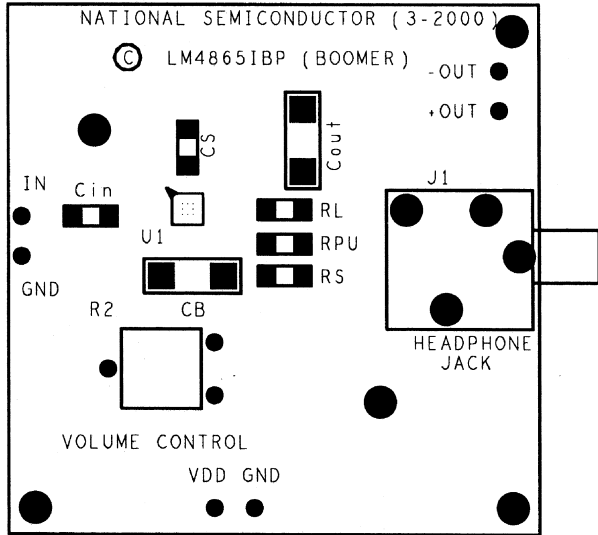

10102541

FIGURE 7. Recommended micro SMD PC board layout: component side silkscreen

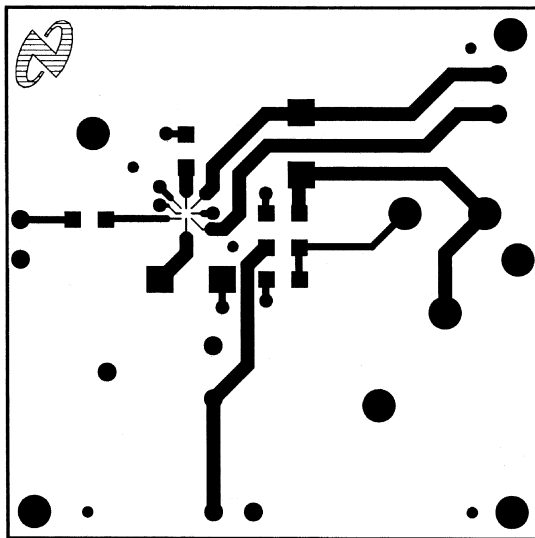

10102542

FIGURE 8. Recommended micro SMD PC board layout: component side layout

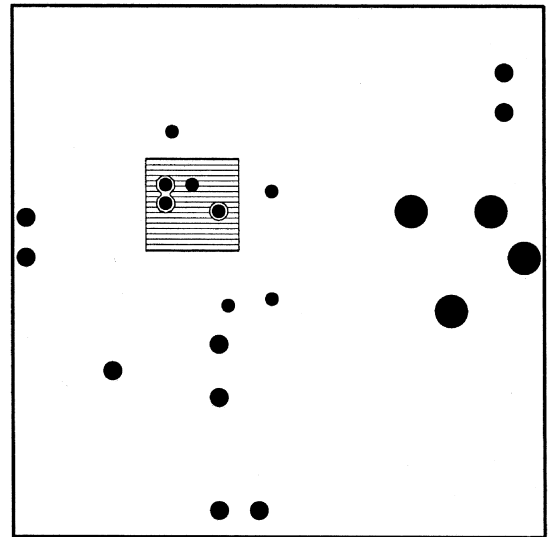

10102543

FIGURE 9. Recommended micro SMD PC board layout: Inner layer V_{CC} layout

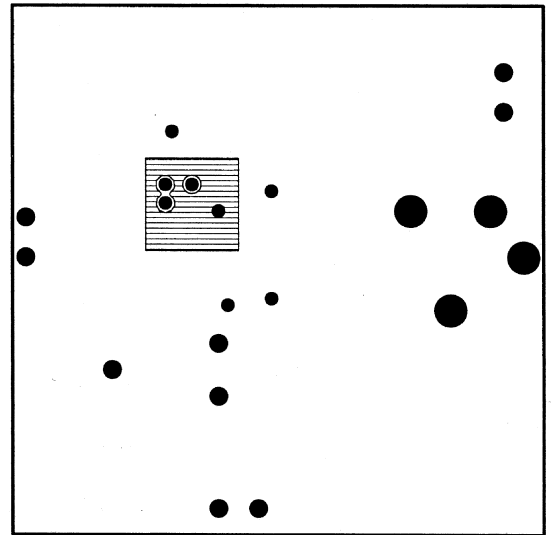

10102544

FIGURE 10. Recommended micro SMD PC board layout: Inner layer ground layout

Application Information (Continued)

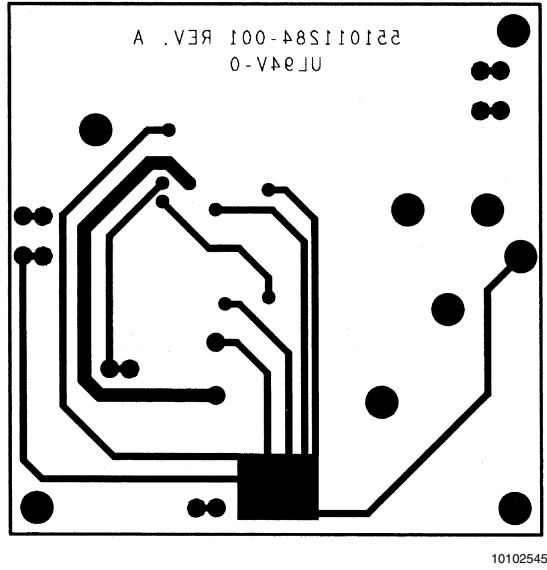

**FIGURE 11. Recommended micro SMD PC board layout:
bottom side layout**

Physical Dimensions inches (millimeters) unless otherwise noted

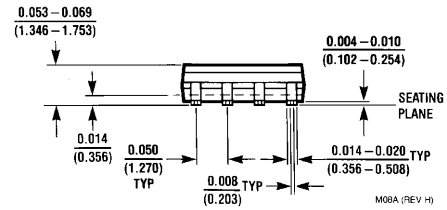
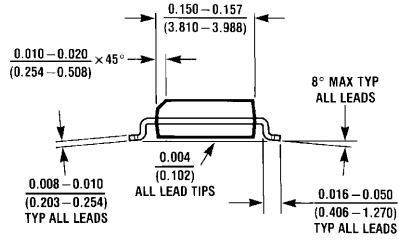
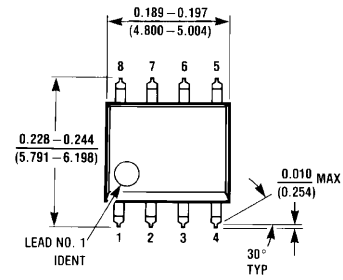

Order Number LM4865M
NS Package Number M08A

Physical Dimensions inches (millimeters) unless otherwise noted (Continued)

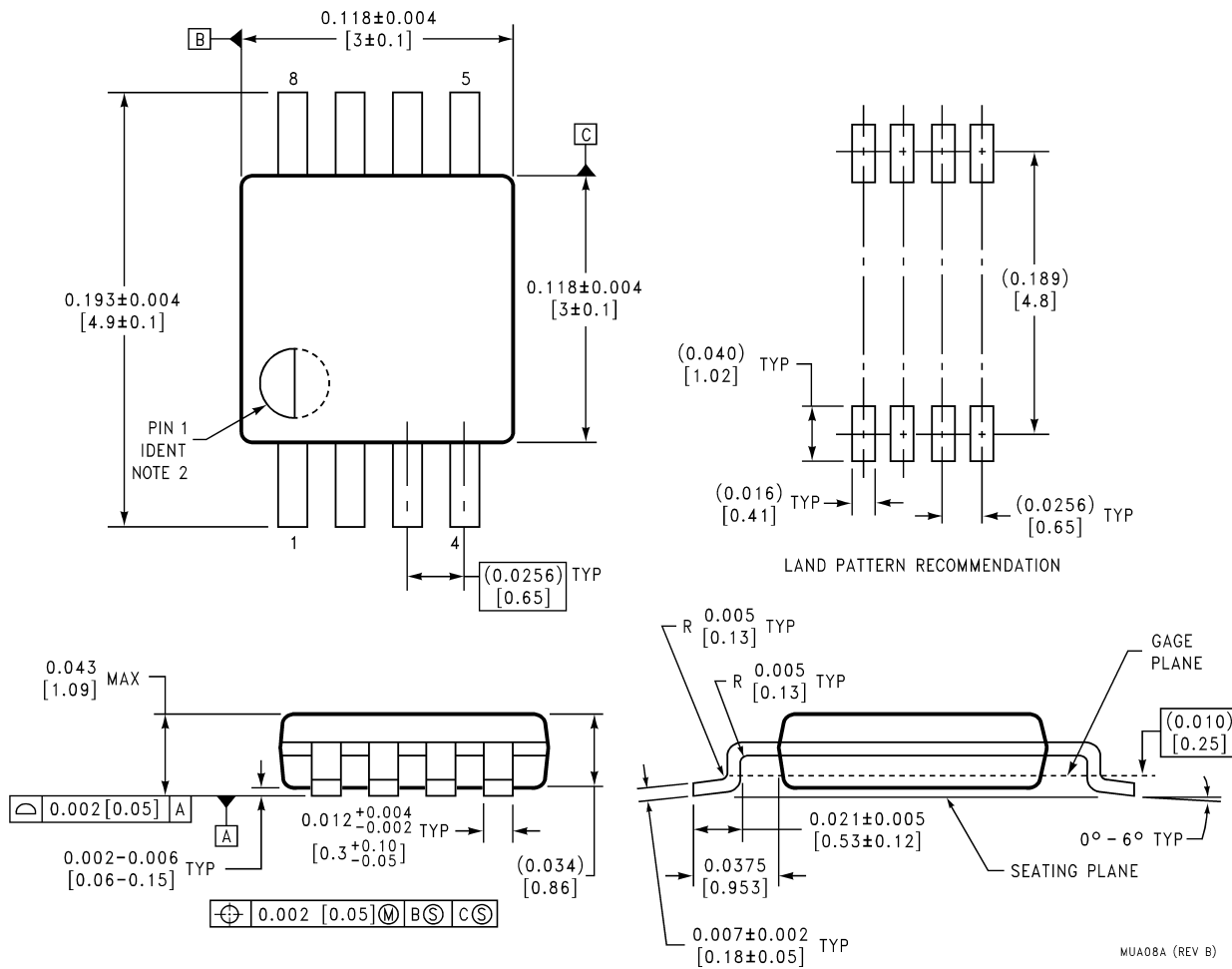

8-Lead (0.118' Wide) Molded Mini Small Outline Package
Order Number LM4865MM
NS Package Number MUA08A

Physical Dimensions inches (millimeters) unless otherwise noted (Continued)

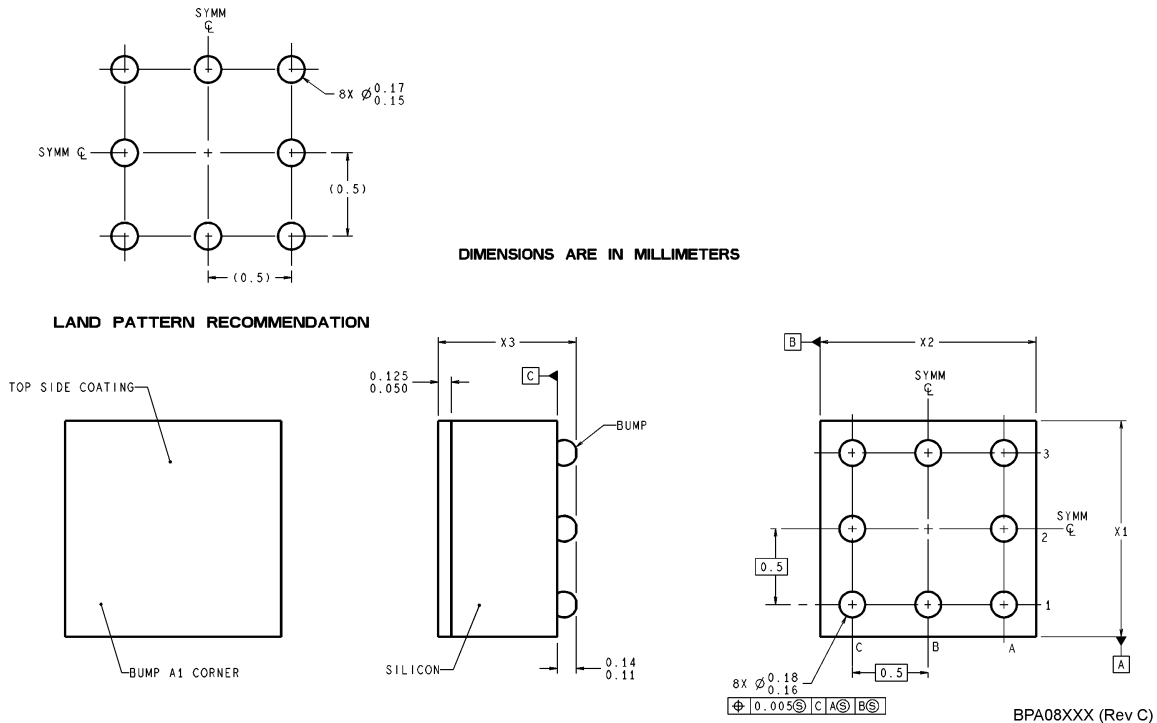

8-Bump micro SMD
Order Number LM4865IBP, LM4865IBPX
NS Package Number BPA08CFB
X1 = 1.336± 0.03 X2 = 1.412± 0.03 X3 = 0.850± 0.10

LIFE SUPPORT POLICY

NATIONAL'S PRODUCTS ARE NOT AUTHORIZED FOR USE AS CRITICAL COMPONENTS IN LIFE SUPPORT DEVICES OR SYSTEMS WITHOUT THE EXPRESS WRITTEN APPROVAL OF THE PRESIDENT AND GENERAL COUNSEL OF NATIONAL SEMICONDUCTOR CORPORATION. As used herein:

1. Life support devices or systems are devices or systems which, (a) are intended for surgical implant into the body, or (b) support or sustain life, and whose failure to perform when properly used in accordance with instructions for use provided in the labeling, can be reasonably expected to result in a significant injury to the user.
2. A critical component is any component of a life support device or system whose failure to perform can be reasonably expected to cause the failure of the life support device or system, or to affect its safety or effectiveness.

National Semiconductor
Americas Customer Support Center
 Email: new.feedback@nsc.com
 Tel: 1-800-272-9959
 www.national.com

National Semiconductor
Europe Customer Support Center
 Fax: +49 (0) 180-530 85 86
 Email: europe.support@nsc.com
 Deutsch Tel: +49 (0) 69 9508 6208
 English Tel: +44 (0) 870 24 0 2171
 Français Tel: +33 (0) 1 41 91 8790

National Semiconductor
Asia Pacific Customer Support Center
 Fax: 65-6250 4466
 Email: ap.support@nsc.com
 Tel: 65-6254 4466

National Semiconductor
Japan Customer Support Center
 Fax: 81-3-5639-7507
 Email: nsj.crc@jksmtp.nsc.com
 Tel: 81-3-5639-7560