

NIR-MX-LN series

1000 nm band Intensity Modulator

MODULATOR



FEATURES

- Optical input power capability: 25 dBm
- Superior Extinction ratio > 30 dB
- X-cut for high stability
- Low drive voltage
- Low insertion loss

APPLICATIONS

- Pulse generation / picking
- Carrier suppression
- Fiber optics sensors
- Pulse applications
- Analog transmission

OPTIONS

- Lower insertion loss
- Higher polarization extinction ratio

RELATED EQUIPMENTS

- RF amplifiers
- MBC-DG Automatic Bias Controllers
- ModBox-FE, PS, PG

The NIR-MX-LN series are an intensity modulator especially designed for operation in the 1000 nm wavelength band.

This Mach-Zehnder modulator offers engineers working in the 1000 nm the intrinsic and unparalleled benefits of LiNbO₃ external modulation : high bandwidth, high contrast up to 30 dB and beyond, low insertion loss, high polarization extinction ratio, ease of use.

Like all ixblue Near InfraRed (NIR) modulators, the NIR-MX series use a proton exchanged based waveguide process that confers them an unparalleled stability even when operating at high optical power up to 25 dBm. The NIR-MX amplitude modulators come with high PER and Low IL options.

NIR-MX-LN-10 Performance Highlights

Parameter	Min	Typ	Max	Unit
Operating wavelength	980	-	1150	nm
Insertion loss	-	3.5	-	dB
Insertion loss (with low IL option)	-	2.5	-	dB
Extinction ratio	-	30	-	dB
Electro-optical bandwidth	-	12	-	GHz
V _π RF @10 GHz	-	4.5	-	V

Specifications given at 25 °C, 1060 nm

NIR-MX-LN-20 Performance Highlights

Parameter	Min	Typ	Max	Unit
Operating wavelength	980	-	1150	nm
Insertion loss	-	3.5	-	dB
Insertion loss (with low IL option)	-	2.5	-	dB
Extinction ratio	-	30	-	dB
Electro-optical bandwidth	-	18	-	GHz
V _π RF @20 GHz	-	6	-	V

Specifications given at 25 °C, 1060 nm

NIR-MX-LN series
1000 nm band Intensity Modulator

MODULATOR

NIR-MX-LN-10
12 GHz Amplitude Modulator

Electrical Characteristics

Parameter	Symbol	Condition	Min	Typ	Max	Unit
Electro-optic bandwidth	S_{21}	RF electrodes, from 2 GHz	10	12	-	GHz
Rise time / Fall time	t_r/t_f	20 % - 80 %, ⁽¹⁾	-	35 / 35	-	ps
Ripple S_{21}	ΔS_{21}	RF electrodes	-	0.5	1	dB
Electrical return loss	S_{11}	RF electrodes, $f < 10$ GHz	-	-12	-10	dB
V π RF @ 50 kHz	V π RF _{50 kHz}	RF electrodes	-	3.5	4.5	V
V π RF @ 10 GHz	V π RF _{10 GHz}	RF electrodes	-	4.5	5.5	V
V π DC electrodes	V π DC	DC electrodes	-	4.5	5	V
RF input impedance	Z _{in-RF}	-	-	50	-	Ω
DC input impedance	Z _{in-DC}	-	-	1	-	M Ω

(1) Rise and fall times are achieved when the NIR-MX-LN-10 is associated with the driver DR-PL-10-MO or its equivalent.

Optical Characteristics

Parameter	Symbol	Condition	Min	Typ	Max	Unit
Crystal	-	-	Lithium Niobate X-Cut Y-Prop			
Operating wavelength	λ	-	980	1060	1150	nm
Insertion loss	IL	Standard, without connectors	-	3.5	4.5	dB
Insertion loss (with low IL option)	LIL	Option, without connectors	-	2.5	3.5	dB
DC extinction ratio	ER > 20	Measured @ 1060 nm by default, for other lambda ⁽¹⁾ please contact us	20	-	-	dB
	ER > 25		25	-	-	dB
	ER > 30		30	-	-	dB
Polarization Extinction Ratio	PER	Standard, without connectors	20	-	-	dB
High Polarization Extinction Ratio	HPER	Option, without connectors	25	-	-	dB
Optical return loss	ORL	-	-40	-45	-	dB
Chirp	α	-	-0.1	0	0.1	-

(1) ixblue can provide high extinction ratio modulator at 1030 nm, 1053 nm, 1060 nm, 1064 nm.

Absolute Maximum Ratings

Stresses in excess of the absolute maximum ratings can cause permanent damage to the device. These are absolute stress ratings only. Functional operation of the device is not implied at these or any other conditions in excess of those given in the operational sections of the data sheet. Exposure to absolute maximum ratings for extended periods can adversely affect device reliability.

Parameter	Symbol	Min	Max	Unit
RF input power	EP _{in}	-	28	dBm
Bias voltage	V _{bias}	-20	+20	V
Optical input power	OP _{in}	-	25	dBm
Operating temperature	OT	0	+70	°C
Storage temperature	ST	-40	+85	°C

NIR-MX-LN series
1000 nm band Intensity Modulator

MODULATOR

NIR-MX-LN-20
18 GHz Amplitude Modulator

Electrical Characteristics

Parameter	Symbol	Condition	Min	Typ	Max	Unit
Electro-optic bandwidth	S_{21}	RF electrodes, from 2 GHz	16	18	-	GHz
Rise time / Fall time	t_r/t_f	20% - 80%, ⁽¹⁾	-	20 / 20	-	ps
Ripple S_{21}	ΔS_{21}	RF electrodes	-	0.5	1	dB
Electrical return loss	S_{11}	RF electrodes, $f < 18$ GHz	-	-12	-10	dB
V π RF @ 50 kHz	V π RF _{50 kHz}	RF electrodes	-	3.5	4.5	V
V π RF @ 10 GHz	V π RF _{10 GHz}	RF electrodes	-	6	7	V
V π DC electrodes	V π DC	DC electrodes	-	4.5	5	V
RF input impedance	Z _{in-RF}	-	-	50	-	Ω
DC input impedance	Z _{in-DC}	-	-	1	-	M Ω

(1) Rise and fall times are achieved when the NIR-MX-LN-20 is associated with the driver DR-PL-20-MO or its equivalent.

Optical Characteristics

Parameter	Symbol	Condition	Min	Typ	Max	Unit
Crystal	-	-	Lithium Niobate X-Cut Y-Prop			
Operating wavelength	λ	-	980	1060	1150	nm
Insertion loss	IL	Standard, without connectors	-	3.5	4.5	dB
Insertion loss (with low IL option)	LIL	Option, without connectors	-	2.5	3.5	dB
DC extinction ratio	ER > 20	Measured @ 1060 nm by default, for other lambda ⁽¹⁾ please contact us	20	-	-	dB
	ER > 25		25	-	-	dB
	ER > 30		30	-	-	dB
Polarization Extinction Ratio	PER	Standard, without connectors	20	-	-	dB
High Polarization Extinction Ratio	HPER	Option, without connectors	25	-	-	dB
Optical return loss	ORL	-	-40	-45	-	dB
Chirp	α	-	-0.1	0	0.1	-

(1) ixBlue can provide high extinction ratio modulator at 1030 nm, 1053 nm, 1060 nm, 1064 nm.

Absolute Maximum Ratings

Stresses in excess of the absolute maximum ratings can cause permanent damage to the device. These are absolute stress ratings only. Functional operation of the device is not implied at these or any other conditions in excess of those given in the operational sections of the data sheet. Exposure to absolute maximum ratings for extended periods can adversely affect device reliability.

Parameter	Symbol	Min	Max	Unit
RF input power	EP _{in}	-	28	dBm
Bias voltage	V _{bias}	-20	+20	V
Optical input power	OP _{in}	-	25	dBm
Operating temperature	OT	0	+70	°C
Storage temperature	ST	-40	+85	°C

NIR-MX-LN series

1000 nm band Intensity Modulator

MODULATOR

NIR-MX-LN-10: S_{21} & S_{11} Parameter Curves

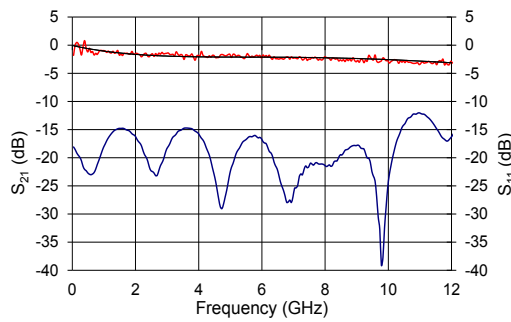

NIR-MX-LN-20: S_{21} & S_{11} Parameter Curves

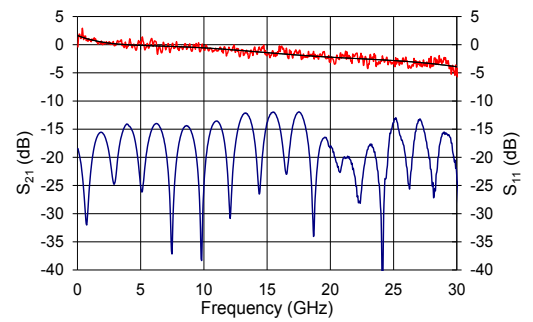

NIR-MX-LN-10: 100 ps Square Pulse

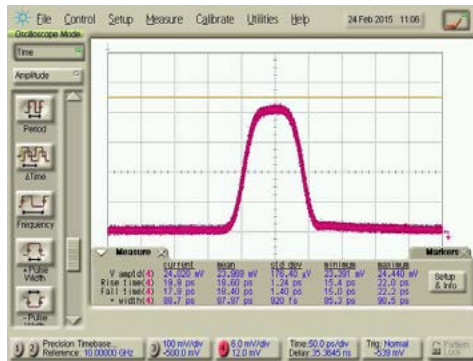

NIR-MX-LN-20: 30 ps Square Pulse

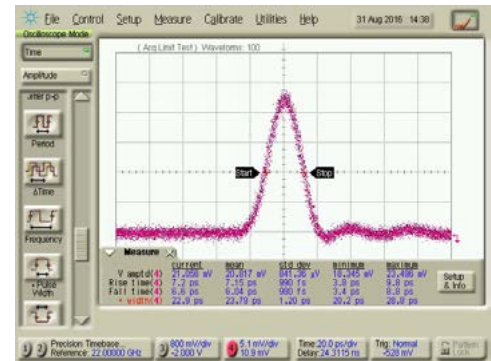

Extinction Ratio

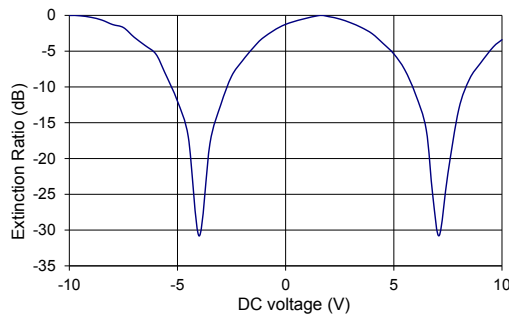

Stability with Time and Temperature

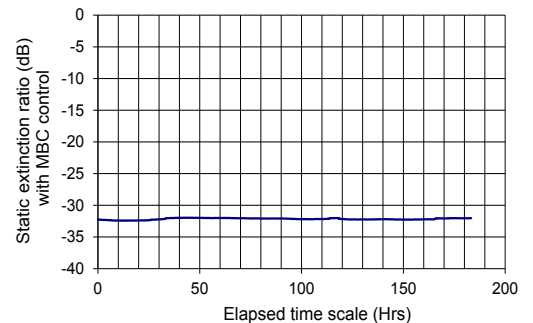

NIR-MX-LN series

1000 nm band Intensity Modulator

MODULATOR

Mechanical Diagram and Pinout

All measurements in mm

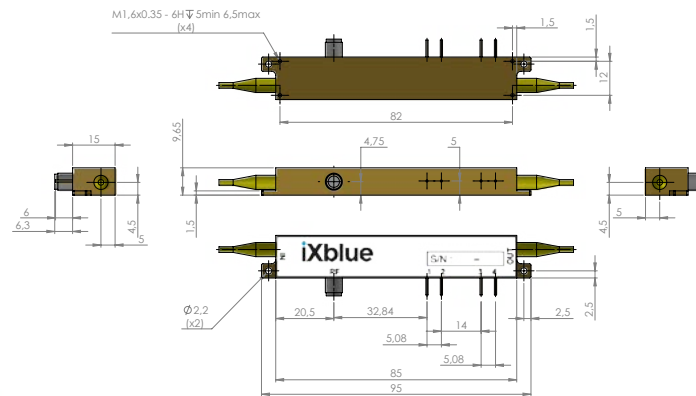

Port	Function	Note
IN	Optical input port	Polarization maintaining fiber, Corning PM 98-U25D, Length 1.5 meter. Buffer diameter 900 mm
OUT	Optical output port	Polarization maintaining fiber, Corning PM 98-U25D, Length 1.5 meter. Buffer diameter 900 mm
RF	RF input port	Female K
1	Ground	Pin feed through diameter 1.0 mm
2	DC	Pin feed through diameter 1.0 mm
3,4	Photodiode cathode, anode	Pin feed through diameter 1.0 mm

Ordering information

NIR-MX-LN-BW-XX-Y-Z-AB-CD-ER-^{LIL}PER

BW = Bandwidth: 10 10 GHz 20 20 GHz
 XX = Internal photodiode: 00 Not integrated PD PD Integrated
 Y = Input fiber: P Polarization maintaining
 Z = Output fiber: P Polarization maintaining
 AB = Output connector: 00 bare fiber FA FC/APC FC FC/SPC
 CD = Output connector: 00 bare fiber FA FC/APC FC FC/SPC
 ER = Extinction ratio: 20 20 dB 25 25 dB 30 30 dB
 PER = High Polarization Extinction Ratio option
 LIL = Low Insertion Loss option

About us

iXblue Photonics produces specialty optical fibers and Bragg gratings based fiber optics components and provides optical modulation solutions based on the company lithium niobate (LiNbO₃) modulators and RF electronic modules.

iXblue Photonics serves a wide range of industries: sensing and instruments, defense, telecommunications, space and fiber lasers as well as research laboratories all over the world.

iXblue reserves the right to change, at any time and without notice, the specifications, design, function or form of its products described herein. All statements, specification, technical information related to the products herein are given in good faith and based upon information believed to be reliable and accurate at the moment of printing. However the accuracy and completeness thereof is not guaranteed. No liability is assumed for any inaccuracies and as a result of use of the products. The user must validate all parameters for each application before use and he assumes all risks in connection with the use of the products