

Right Angle Cable Plugs (male)

> for semi-rigid cables, SUCOFORM and MULTIFLEX cables

- > cable entry soldered
- > centre contact soldered

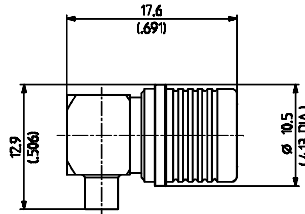

SUHNER TYPE	Article No.	Cable Group (example)	Packaging	Assembly Instruction	Notes
16 QMA-50-2-3 / 133 NE	23017666	Y11,Y3 (Sucoform 86)	single	27444	
16 QMA-50-2-3 / 133 NH	23017667	Y11,Y3 (Sucoform 86)	bulk 100 pcs.	27444	

> for semi-rigid cables, SUCOFORM and MULTIFLEX cables

- > cable entry soldered
- > centre contact soldered

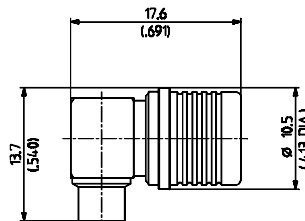

SUHNER TYPE	Article No.	Cable Group (example)	Packaging	Assembly Instruction	Notes
16 QMA-50-3-3 / 133 NE	23017693	Y12,Y5 (Sucoform 141)	single	27444	
16 QMA-50-3-3 / 133 NH	23017694	Y12,Y5 (Sucoform 141)	bulk 100 pcs.	27444	

> for flexible cables

- > cable entry crimp
- > centre contact soldered

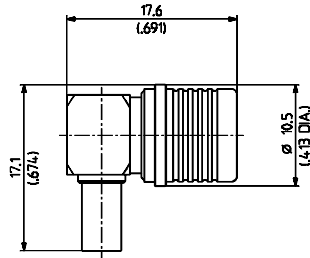

SUHNER TYPE	Article No.	Cable Group (example)	Packaging	Assembly Instruction	Crimp Insert
16 QMA-50-2-1 / 133 NE	23017654	U4 (K 02252 D)	single	27443	A
16 QMA-50-2-1 / 133 NH	23017644	U4 (K 02252 D)	bulk 100 pcs.	27443	A
16 QMA-50-2-2 / 133 NE	23017657	U2 (RG 316/U)	single	27443	A
16 QMA-50-2-2 / 133 NH	23017658	U2 (RG 316/U)	bulk 100 pcs.	27443	A

> for flexible cables

- > cable entry crimp
- > centre contact soldered

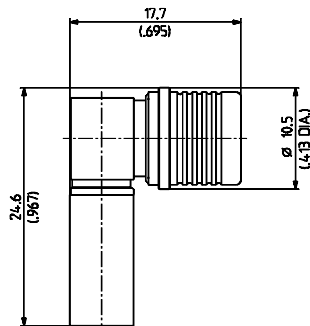

SUHNER TYPE	Article No.	Cable Group (example)	Packaging	Assembly Instruction	Crimp Insert
16 QMA-50-3-1 / 133 NE	23017686	U9,U11 (RG 400/U)	single	27443	B
16 QMA-50-3-1 / 133 NH	23017687	U9,U11 (RG 400/U)	bulk 100 pcs.	27443	B
16 QMA-50-3-2 / 133 NE	23017691	U7 (RG 58 C/U)	single	27443	B
16 QMA-50-3-2 / 133 NH	23017692	U7 (RG 58 C/U)	bulk 100 pcs.	27443	B

> for flexible cables

- > cable entry crimp
- > centre contact soldered

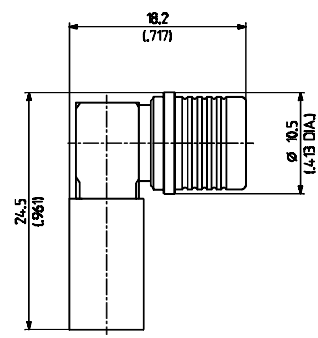

SUHNER TYPE	Article No.	Cable Group (example)	Packaging	Assembly Instruction	Crimp Insert
16 QMA-50-4-1 / 133 NH	23012849	S16 (S 04262 D)	bulk 100 pcs.	27405	C

Straight Bulkhead Cable Jacks (female)

> for semi-rigid cables, SUCOFORM and MULTIFLEX cables

- > cable entry soldered
- > centre contact plugged-in
- > with panel seal

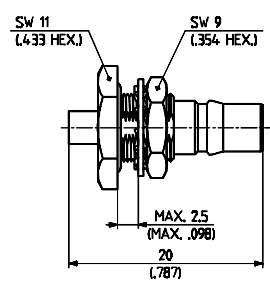

SUHNER TYPE	Article No.	Cable Group (example)	Packaging	Assembly Instruction/ Mounting Hole	Notes
24 QMA-50-2-1 / 111 NE	23017742	Y11,Y3 (Sucoform 86)	single	27428 / ML 20	
24 QMA-50-2-1 / 111 NH	23017743	Y11,Y3 (Sucoform 86)	bulk 100 pcs.	27428 / ML 20	

> for semi-rigid cables, SUCOFORM and MULTIFLEX cables

- > cable entry soldered
- > centre contact plugged-in
- > with panel seal

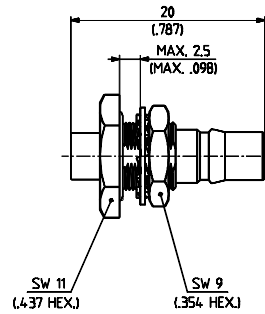

SUHNER TYPE	Article No.	Cable Group (example)	Packaging	Assembly Instruction/ Mounting Hole	Notes
24 QMA-50-3-3 / 111 NE	23017683	Y12,Y5 (Sucoform 141)	single	27428 / ML 20	
24 QMA-50-3-3 / 111 NH	23017684	Y12,Y5 (Sucoform 141)	bulk 100 pcs.	27428 / ML 20	

> for flexible cables

- > cable entry crimp
- > centre contact soldered
- > with panel seal

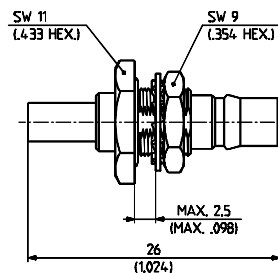

SUHNER TYPE	Article No.	Cable Group (example)	Packaging	Assembly Instruction/ Mounting Hole	Crimp Insert
24 QMA-50-2-2 / 133 NE	23017829	U4 (K 02252 D)	single	27429 / ML 20	A
24 QMA-50-2-2 / 133 NH	23017830	U4 (K 02252 D)	bulk 100 pcs.	27429 / ML 20	A
24 QMA-50-2-3 / 133 NE	23017837	U2 (RG 316/U)	single	27429 / ML 20	A
24 QMA-50-2-3 / 133 NH	23017838	U2 (RG 316/U)	bulk 100 pcs.	27429 / ML 20	A

> for flexible cables

- > cable entry crimp
- > centre contact soldered
- > with panel seal

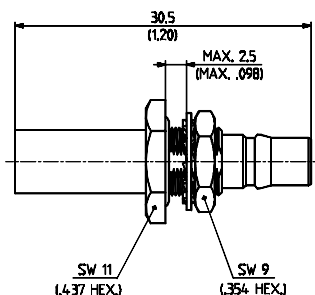

SUHNER TYPE	Article No.	Cable Group (example)	Packaging	Assembly Instruction/ Mounting Hole	Crimp Insert
24 QMA-50-3-1 / 133 NE	23017822	U9,U11 (RG 400/U)	single	27429 / ML 20	B
24 QMA-50-3-1 / 133 NH	23017823	U9,U11 (RG 400/U)	bulk 100 pcs.	27429 / ML 20	B
24 QMA-50-3-2 / 133 NE	23017795	U7 (RG 58 C/U)	single	27429 / ML 20	B
24 QMA-50-3-2 / 133 NH	23017796	U7 (RG 58 C/U)	bulk 100 pcs.	27429 / ML 20	B

Receptacles with Solder End

Receptacles, Jack (female)

- > bulkhead mounted
- > press-in chassis mount

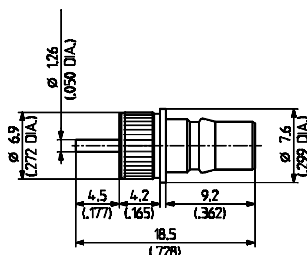

SUHNER TYPE	Article No.	Packaging	Mounting Hole	Notes
22 QMA-50-0-1 / 133 NE	23027250	single	ML 143	press-in

- > bulkhead mounted
- > without panel seal

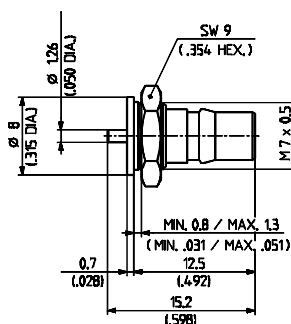

SUHNER TYPE	Article No.	Packaging	Mounting Hole	Notes
22 QMA-50-0-3 / 133 NH	23018585	bulk 100 pcs.	ML 20	flush dielectric

- > bulkhead mounted
- > without panel seal

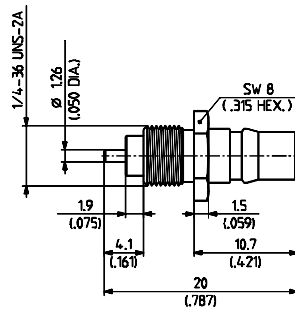

SUHNER TYPE	Article No.	Packaging	Notes
22 QMA-50-0-4 / 133 NH	23022628	bulk 100 pcs.	extended dielectric

- > panel mounted
- > 2-hole flange

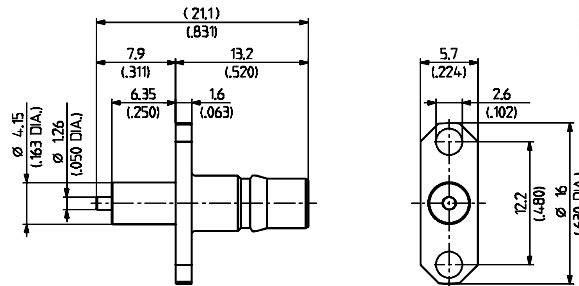

SUHNER TYPE	Article No.	Packaging	Notes
23 QMA-50-0-2 / 111 NH	23024985	bulk 100 pcs.	extended dielectric

- > panel mounted
- > 4-hole flange

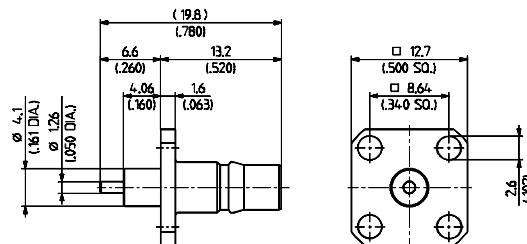

SUHNER TYPE	Article No.	Packaging	Notes
23 QMA-50-0-3 / 111 NH	23025007	bulk 100 pcs.	extended dielectric