

# PTF 10037

## 120 Watts, 470–860 MHz

### LDMOS Field Effect Transistor

**Description**

The 10037 is an internally matched, common source n-channel enhancement-mode lateral MOSFET intended for large signal amplifier applications from 470 to 860 MHz. It is rated at 120 watts minimum output power. Nitride surface passivation and gold metallization ensure excellent device lifetime and reliability. 100% lot traceability is standard.

- **INTERNALLY MATCHED** for ease of circuit design
- Performance at 860 MHz, 32 Volts
  - Output Power = 120 Watts Typ
  - Power Gain = 14.0 dB Typ
  - Efficiency = 50% Typ
- Performance at 860 MHz, 28 Volts
  - Output Power = 100 Watts
  - Power Gain = 14.0 dB Typ
  - Efficiency = 50% Typ
- Gold Metallization
- Silicon Nitride Passivated
- Back Side Common Source

3

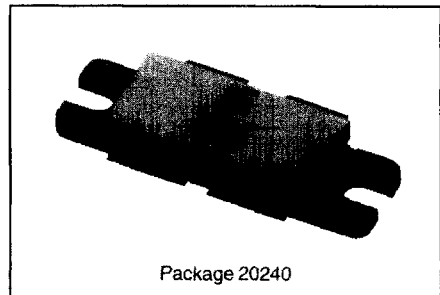
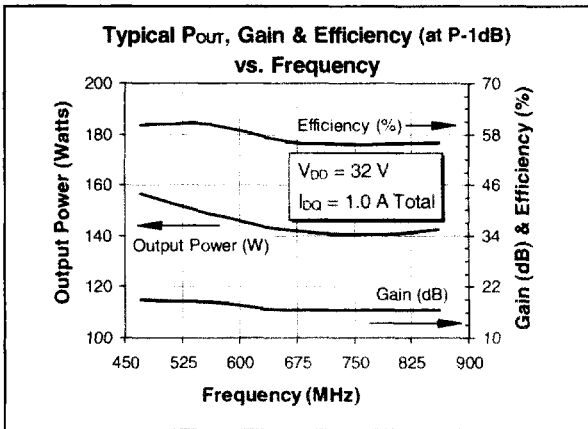

**Maximum Ratings**

Parameter	Symbol	Value	Unit
Drain-Source Voltage	$V_{DSS}$	65	Vdc
Gate-Source Voltage	$V_{GS}$	$\pm 20$	Vdc
Operating Junction Temperature	$T_J$	200	$^{\circ}C$
Total Device Dissipation at $T_{flange} = 25^{\circ}C$ Above $25^{\circ}C$ derate by	$P_D$	290 1.67	Watts $W/^{\circ}C$
Storage Range	$T_{STG}$	-40 to +150	$^{\circ}C$
Thermal Resistance	$R_{\theta JC}$	0.6	$^{\circ}C/W$

GOLD LDMOS

## Electrical Characteristics (100% Tested)

Characteristic	Conditions	Symbol	Min	Typ	Max	Units
Drain-Source Breakdown Voltage	$V_{GS} = 0\text{ V}, I_D = 5\text{ mA}$	$V_{(BR)DSS}$	65	—	—	Volts
Drain-Source Leakage Current	$V_{DS} = 28\text{ V}, V_{GS} = 0\text{ V}$	$I_{DSS}$	—	—	1.0	mA
Gate Threshold Voltage	$V_{DS} = 10\text{ V}, I_D = 75\text{ mA}$	$V_{GS(th)}$	—	3.0	—	Volts
Forward Transconductance	$V_{DS} = 10\text{ V}, I_D = 3\text{ A}$	$g_{fs}$	—	2.5	—	Siemens

### 3

## RF Specifications (100% Tested)

Characteristic	Symbol	Min	Typ	Max	Units
<b>Gain</b> ( $V_{DD} = 32\text{ V}, P_{out} = 120\text{ W}, I_{DQ} = 1.0\text{ A Total}, f = 860\text{ MHz}$ )	$G_{ps}$	12.0	14.0	—	dB
<b>Drain Efficiency</b> ( $V_{DD} = 32\text{ V}, P_{out} = 120\text{ W}, I_{DQ} = 1.0\text{ A Total}, f = 860\text{ MHz}$ )	$\eta$	45	50	—	%
<b>Power Output at 1 dB Compression</b> ( $V_{DD} = 32\text{ V}, I_{DQ} = 1.0\text{ A Total}, f = 860\text{ MHz}$ )	P-1dB	115	125	—	Watts
<b>Load Mismatch Tolerance</b> ( $V_{DD} = 32\text{ V}, P_{out} = 120\text{ W}, I_{DQ} = 1.0\text{ A Total}, f = 860.0\text{ MHz}$ — all phase angles at frequency of test)	$\Psi$	—	—	5:1	—

## Typical Performance

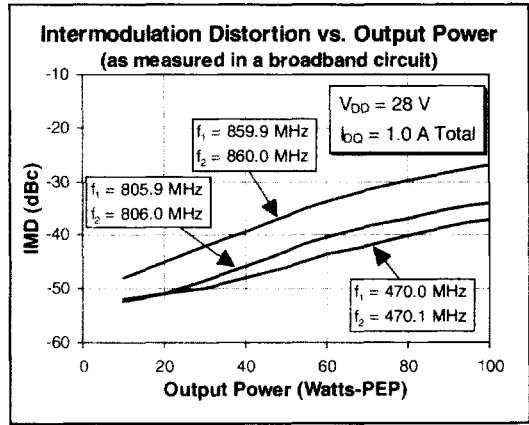
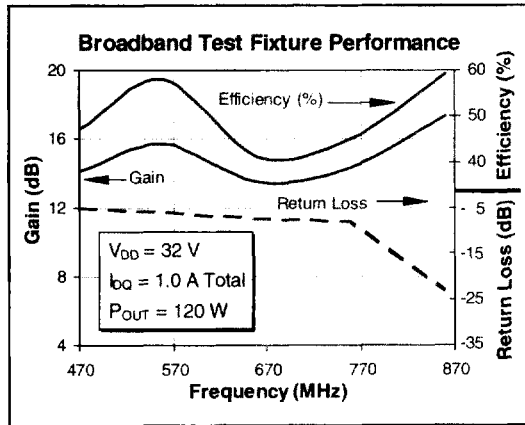

**GOLD LDMOS**

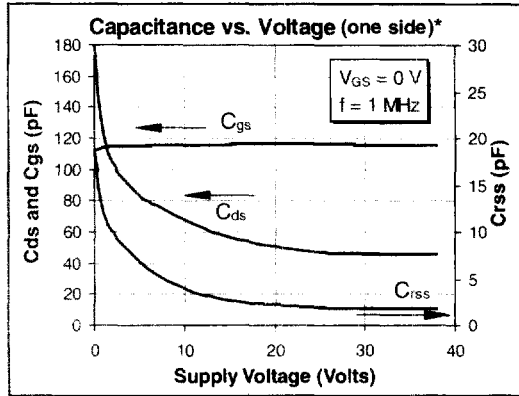
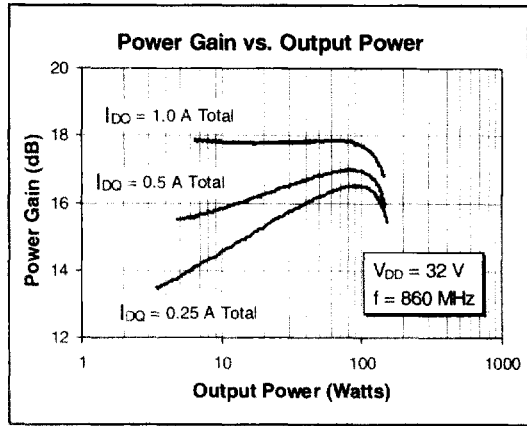
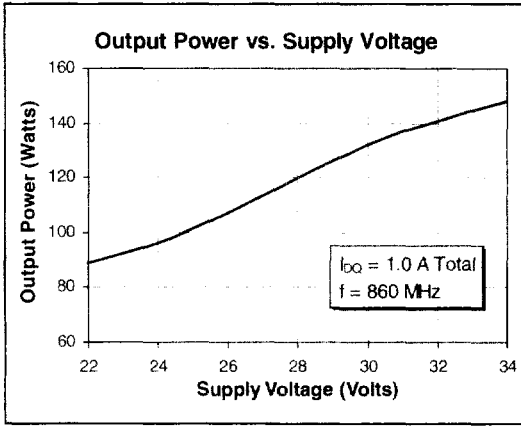

\*This part is internally matched. Measurements of the finished product will not yield these figures.

Impedance Data

$V_{DD} = 32\text{ V}$ ,  $P_{out} = 120\text{ W}$ ,  $I_{DQ} = 1.0\text{ A Total}$

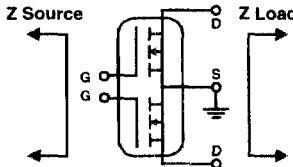

Frequency MHz	Z Source		Z Load	
	R	jX	R	jX
445	1.1	-3.3	5.5	2.3
470	1.2	-3.8	6.0	3.5
560	2.1	-6.3	5.4	3.7
660	4.0	-10.1	4.3	3.0
760	7.0	-5.8	3.5	0.4
860	3.9	-2.0	2.8	-1.4
885	1.3	-1.7	3.7	-1.0

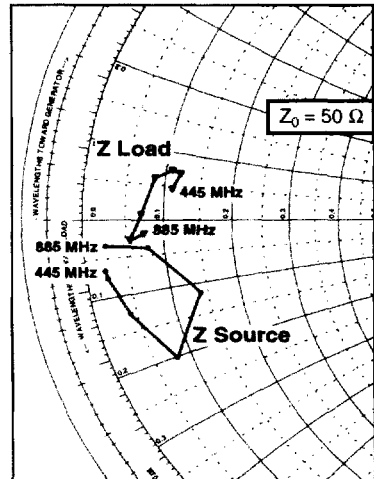

## Typical Scattering Parameters

(V<sub>DS</sub> = 28 V, I<sub>DQ</sub> = 4 A)

f (MHz)	S11		S21		S12		S22	
	Mag	Ang	Mag	Ang	Mag	Ang	Mag	Ang
400	0.966	178.5	1.564	14	0.003	-46.5	0.919	-164.8
410	0.965	178.3	1.535	12.7	0.003	-47.5	0.922	-165.1
420	0.964	178.2	1.509	11.5	0.003	-49.2	0.925	-165.3
430	0.964	177.9	1.487	10.3	0.003	-50.4	0.929	-165.6
440	0.963	177.7	1.464	9	0.003	-50.8	0.933	-165.9
450	0.962	177.5	1.445	7.7	0.003	-49.9	0.937	-166.2
460	0.961	177.2	1.431	6.6	0.003	-51.7	0.941	-166.3
470	0.958	177.1	1.417	5.4	0.003	-50.9	0.944	-166.5
480	0.956	176.9	1.409	4.3	0.003	-51.4	0.946	-166.7
490	0.955	176.7	1.405	3.1	0.003	-52.8	0.948	-166.9
500	0.953	176.4	1.405	1.8	0.003	-54.9	0.951	-167
510	0.951	176.2	1.41	0.5	0.003	-53.1	0.955	-167.2
520	0.949	175.9	1.417	-1	0.003	-56.5	0.957	-167.3
530	0.947	175.6	1.429	-2.6	0.003	-55.8	0.959	-167.6
540	0.944	175.3	1.441	-4.2	0.003	-53.3	0.961	-167.8
550	0.942	175	1.457	-6	0.003	-57.1	0.963	-168.2
560	0.936	174.7	1.476	-8	0.003	-58.2	0.966	-168.4
570	0.931	174.4	1.497	-10	0.003	-59.6	0.967	-168.7
580	0.926	174.1	1.522	-12.2	0.003	-61.1	0.969	-168.9
590	0.918	173.8	1.55	-14.4	0.003	-64.9	0.973	-169.1
600	0.911	173.5	1.587	-16.7	0.003	-67.7	0.977	-169.2
610	0.904	173.3	1.632	-19.3	0.003	-74.1	0.98	-169.4
620	0.893	173	1.684	-22.2	0.003	-74	0.985	-169.6
630	0.882	172.7	1.743	-25.6	0.003	-78.8	0.986	-169.9
640	0.869	172.6	1.81	-29.4	0.003	-83.7	0.991	-170.1
650	0.854	172.5	1.879	-33.9	0.003	-87.4	0.993	-170.5
660	0.836	172.7	1.95	-38.9	0.004	-94.1	0.996	-170.9
670	0.817	173.1	2.016	-44.5	0.004	-100.9	0.997	-171.1
680	0.798	174	2.078	-51	0.004	-109	0.998	-171.6
690	0.781	175.3	2.124	-58.1	0.004	-116.1	0.998	-172.1
700	0.768	177	2.135	-66.1	0.004	-124.8	0.998	-172.5
710	0.764	179.2	2.113	-74.3	0.004	-135.3	0.995	-173.1
720	0.769	-178.6	2.048	-82.6	0.004	-145.9	0.991	-173.6
730	0.783	-176.7	1.946	-90.6	0.004	-155.8	0.986	-173.9
740	0.804	-175.3	1.829	-98.2	0.004	-164.9	0.98	-174.1
750	0.828	-174.5	1.692	-105.2	0.004	-172.9	0.975	-174.2
760	0.851	-174.2	1.55	-111.6	0.004	175.4	0.97	-174.2
770	0.871	-174.2	1.414	-117.1	0.004	168.7	0.967	-174.2
780	0.889	-174.4	1.286	-122.2	0.003	160	0.964	-174.1
790	0.906	-174.7	1.169	-126.8	0.003	155.1	0.963	-174.2
800	0.919	-175.2	1.062	-130.6	0.003	147.2	0.96	-174.1
810	0.93	-175.6	0.966	-134.1	0.003	141.7	0.96	-174.1
820	0.94	-176.1	0.88	-137.3	0.003	138.1	0.959	-174.2
830	0.948	-176.5	0.804	-140.1	0.003	135.3	0.958	-174.2
840	0.953	-177.1	0.734	-142.6	0.003	130.4	0.958	-174.2
850	0.96	-177.4	0.672	-144.9	0.003	126.5	0.958	-174.2
860	0.963	-177.9	0.616	-146.7	0.003	123.4	0.958	-174.3
870	0.966	-178.3	0.566	-148.4	0.003	119.6	0.958	-174.2
880	0.97	-178.7	0.523	-149.8	0.003	120.5	0.96	-174.3
890	0.972	-179	0.485	-151.1	0.003	115.9	0.961	-174.2
900	0.973	-179.3	0.452	-152.3	0.003	117.8	0.962	-174.4
910	0.976	-179.6	0.421	-153.5	0.003	113.5	0.962	-174.5
920	0.978	-179.9	0.394	-154.7	0.003	110.1	0.963	-174.6
930	0.979	179.9	0.368	-155.8	0.003	108.3	0.961	-174.6
940	0.982	179.6	0.346	-156.8	0.003	108.2	0.962	-174.7
950	0.983	179.3	0.325	-157.9	0.003	105.5	0.962	-174.9
960	0.983	179.1	0.305	-158.8	0.003	106.6	0.961	-174.8
970	0.985	178.8	0.287	-159.8	0.003	105.2	0.963	-174.9
980	0.985	178.5	0.269	-160.9	0.003	105.6	0.964	-175
990	0.984	178.4	0.254	-161.7	0.003	106.5	0.964	-175
1000	0.987	178.1	0.239	-162.3	0.003	104.6	0.965	-175.1

3

GOLD LDMOS

**Test Circuit**

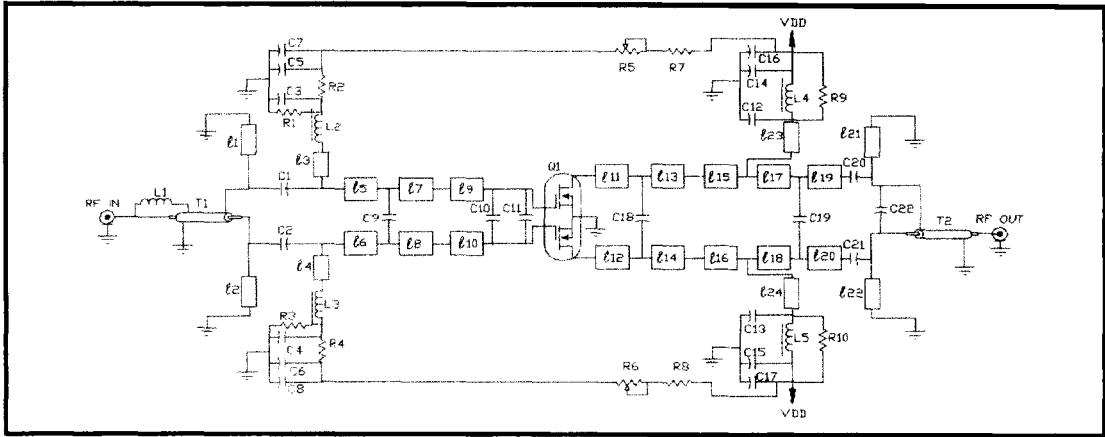

Block diagram for  $f = 470\text{--}860$  MHz broadband circuit

Q1	10037				
L1	1 Turn, #22 AWG, 0.12" I.D.				
L2, L3	10 nH	SMT Coil			
L4, L5	4x8 mm	Ferrite Bead			
ℓ1, ℓ2, ℓ21, ℓ22	0.25 λ 680 MHz	Microstrip 25 Ω	C3, C4, C12, C13	91 pF	Chip Cap ATC 100 B
ℓ3, ℓ4	0.065 λ 800 MHz	Microstrip 70 Ω	G5, C6, C14, C15	0.1 μF	SMT K1206
ℓ5, ℓ6	0.010 λ 800 MHz	Microstrip 18.5 Ω	C7, C8, C16, C17	10 μF	Electrolytic Capacitor
ℓ7, ℓ8	0.07 λ 800 MHz	Microstrip 18.5 Ω	C9	11 pF	Chip Cap ATC 100 B
ℓ9, ℓ10	0.060 λ 800 MHz	Microstrip 10.2 Ω	C10, C22	0.6–6.0 pF	Variable Capacitor, Johanson Trimmer
ℓ11, ℓ12	0.0525 λ 800 MHz	Microstrip 8.1 Ω	C11	4.7 pF	Chip Cap ATC 100 A
ℓ13, ℓ14	0.061 λ 800 MHz	Microstrip 9.3 Ω	C18	13.0 pF	Chip Cap ATC 100 B
ℓ15, ℓ16	0.032 λ 800 MHz	Microstrip 12.13 Ω	C19	3.6 pF	Chip Cap ATC 100 B
ℓ17, ℓ18	0.021 λ 800 MHz	Microstrip 22.6 Ω	R1, R3	200 Ω	1/8 W K 1206 SMT Resistor
ℓ19, ℓ20	0.01 λ 800 MHz	Microstrip 22.6 Ω	R2, R4	200 Ω	1/8 W K 1206 SMT Resistor
ℓ23, ℓ24	0.25 λ 680 MHz	Microstrip 60 Ω	R5, R6	1 K Ω	1/4 W Potentiometer
C1, C2, C20, C21	51 pF	Chip Cap ATC 100 B	R7, R8	500 Ω	1/4 W Resistor
			R9, R10	1.8 Ω	1/4 W Resistor
			T1, T2		UT-85-25 Balun Coaxial
			Circuit Board		0.028" G200, $\epsilon_r = 4.55 @ 1 \text{ MHz}$ , 2 oz. Copper, AlliedSignal

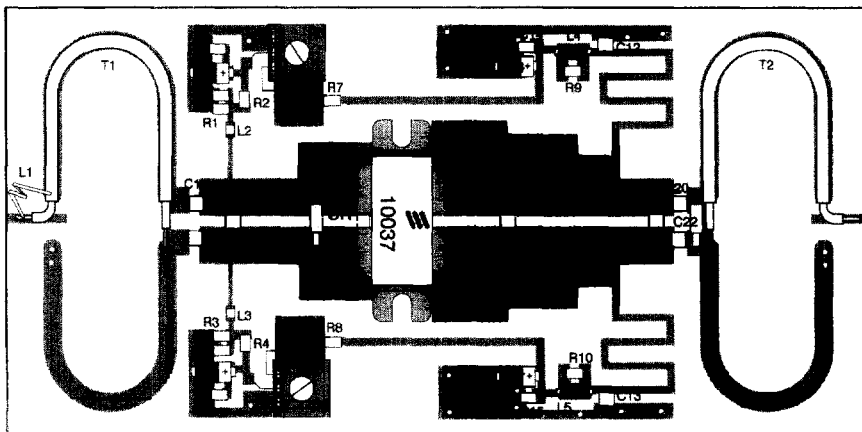

Components layout (not to scale)

3

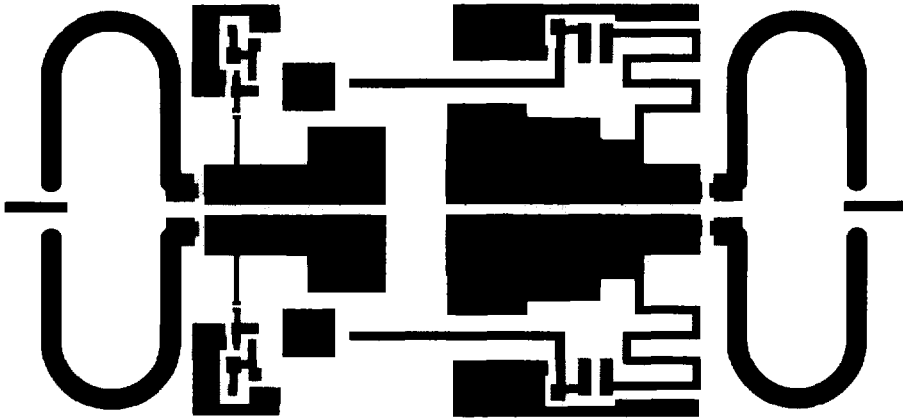

Test circuit artwork (1 inch )

**GOLD LDMOS**