

Angled Female Connectors with CAGE CLAMP®, Pin Spacing 7.5 mm / 0.295 in, Grey

Pin spacing 7.5 mm/0.295 in, grey
0.08 – 2.5 mm² | AWG 28 – 12
400 V/6 kV/3
14 A

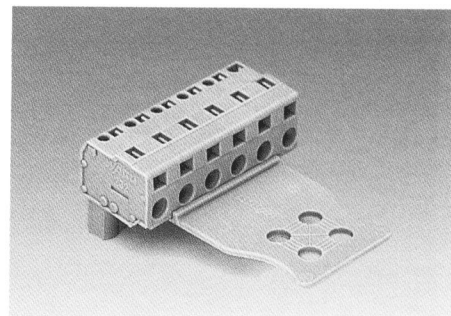
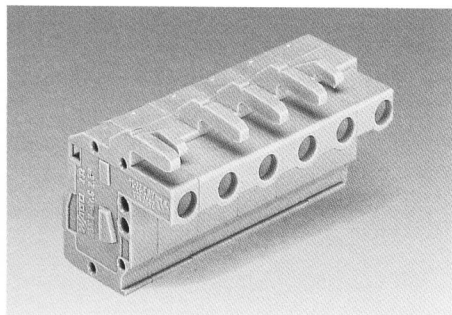

 8 – 9 mm / 0.33 in

For strain relief plates
see page 4.88

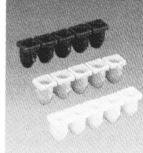

No. of poles	Item-No.	"B"	Additional item-No. for ...
Angled female connectors with CAGE CLAMP®, conductor exit opposite to latches, with coding fingers, with two latches, grey		... Angled female connectors with CAGE CLAMP® and strain relief plate	
2 (one latch only)	732-102/026-000	11.5 mm	.../032-000
3 (one latch only)	732-103/026-000	20 mm	.../033-000
4	732-104/026-000	30 mm	.../034-000
5	732-105/026-000	50 mm	.../035-000
6	732-106/026-000	B = width of strain relief plate	
7	732-107/026-000	Ordering example:	
8	732-108/026-000	Female connector, pin spacing 7.5 mm/0.295 in, grey, with strain relief plate	
9	732-109/026-000	5-pole 732-105/026-000/034-000	
10	732-110/026-000		
11	732-111/026-000		
12	732-112/026-000		
16	732-116/026-000		

Accessories

	Test plug , w. cable 500 mm/1'7.7" 2 mm/0.079 in Ø, red 210-136 2.3 mm/0.091 in Ø, yel. 210-137
	Insulation stop , 5 pcs/strip 0.08 - 0.2 mm ² ① (white) 231-673 0.25 - 0.5 mm ² (light gr.) 231-674 0.75 - 1 mm ² (dark grey) 231-675 ① 0.2 mm ² solid/0.14 mm ² f-st
	Marker strips , self-adhesive 1-16 (20 x) 249-150/210-222

Angled female connectors with conductor exit perpendicular to mating direction offer a space saving of 10 mm/0.394 in in mating direction compared with straight female connectors.

Example of application see page 4.81

Dimensions (in mm) Length = (No. of poles - 1) x pin spacing + 5 mm + 1.5 mm + 0.9 mm

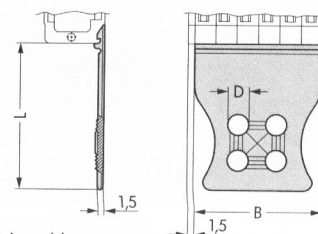
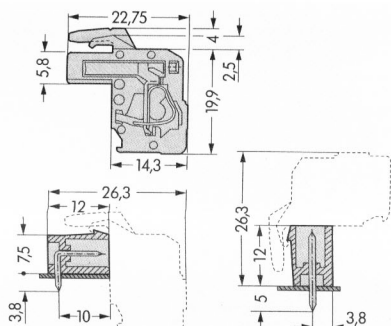

Add. item-No.	B	D	L
.../032-000	B = 11.5	D = 3.7	L = 30
.../033-000	B = 20	D = 3.7	L = 30
.../034-000	B = 30	D = 4.9	L = 35
.../035-000	B = 50	D = 4.9	L = 35