

FUNCTIONAL DESCRIPTION

The XRK4991 is a 3.3V High-Speed Low-Voltage Programmable Skew Clock Buffer. It is intended for high-performance computer systems and offers user selectable control over system clock functions to optimize timing. Eight outputs, arranged in four banks, can each drive 50Ω terminated transmission lines while delivering minimal and specified output skews and full-swing Low Voltage TTL logic levels.

Each bank (two outputs per bank) can be individually selected for one of nine delay or function configurations through two dedicated tri-level inputs. These outputs are able to lead or lag the CLKIN input reference clock by up to 6 time units from their nominal “zero” skew position. The integrated PLL allows external load and transmission line delay effects to be canceled achieving zero delay capability. Combining the zero delay capability with the selectable output skew functions, output-to-output delays of up to ±12 time units can be created.

The XRK4991’s divide functions (divide-by-two and divide-by-four) allow distribution of a low-frequency clock that can be multiplied by two or four at the clock destination. This feature facilitates clock distribution while allowing maximum system clock flexibility.

FEATURES

- 3.75- to 85-MHz output operation
- All output pair skew <100 ps typical
- Three skew grades
 - 2 : $t_{\text{SKEW0}} < 250\text{ps}$
 - 5 : $t_{\text{SKEW0}} < 500\text{ps}$
 - 7 : $t_{\text{SKEW0}} < 700\text{ps}$
- Selectable output functions
 - Skew adjustments of +/- 6t_U (up to 18 ns)
 - Inverted and non-inverted
 - Operation at 1/2 and 1/4 input frequency
 - Operation at 2x and 4x input frequency
- Cycle-Cycle Jitter
 - < 25 ps (rms)
 - < 200 ps (pk-pk)
- Zero input-to-output delay
- 50% duty-cycle outputs
- LVTTTL outputs drive 50Ω terminated lines
- Operates from a single 3.3V supply
- 32-pin PLCC package
- Green packaging
- Lead free lead frame available

FIGURE 1. BLOCK DIAGRAM OF THE XRK4991

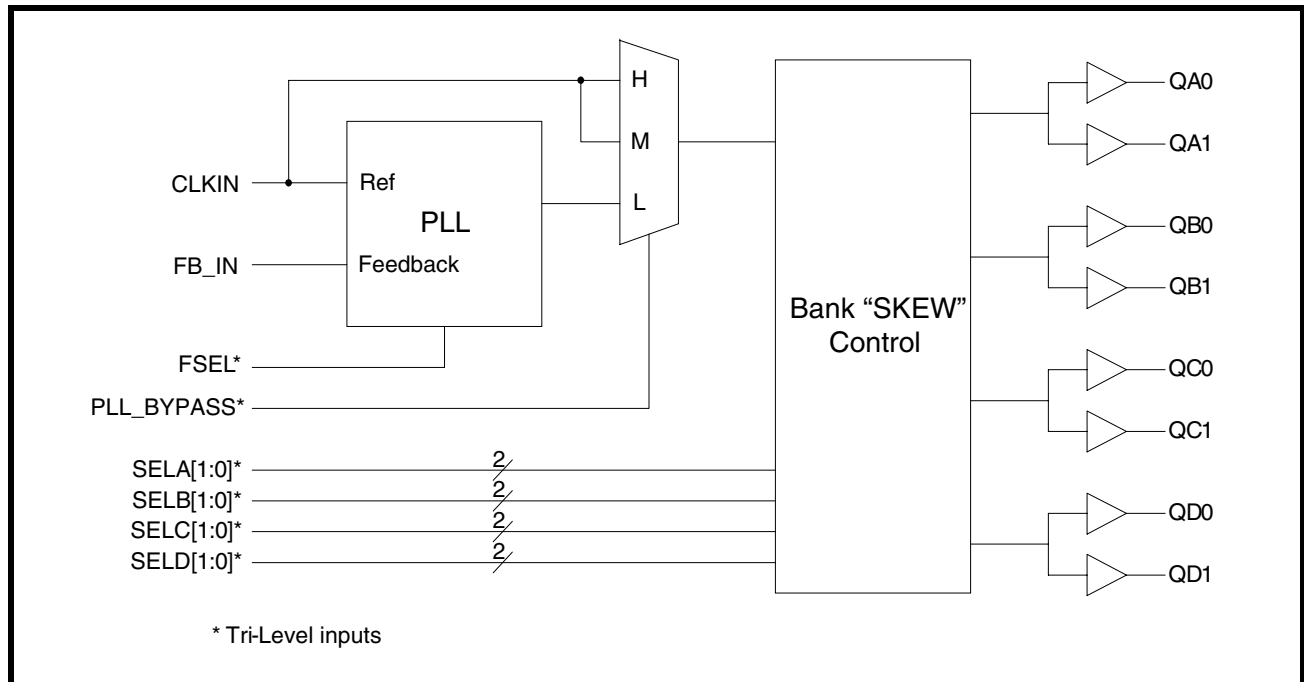

PRODUCT ORDERING INFORMATION

PRODUCT NUMBER	ACCURACY	TEMPERATURE RANGE
XRK4991IJ-2	250 ps	-40°C to +85°C
XRK4991CJ-2	250 ps	0°C to +70°C
XRK4991IJ-5	500 ps	-40°C to +85°C
XRK4991CJ-5	500 ps	0°C to +70°C
XRK4991CJ-7	750 ps	0°C to +70°C

FIGURE 2. PIN OUT OF THE XRK4991

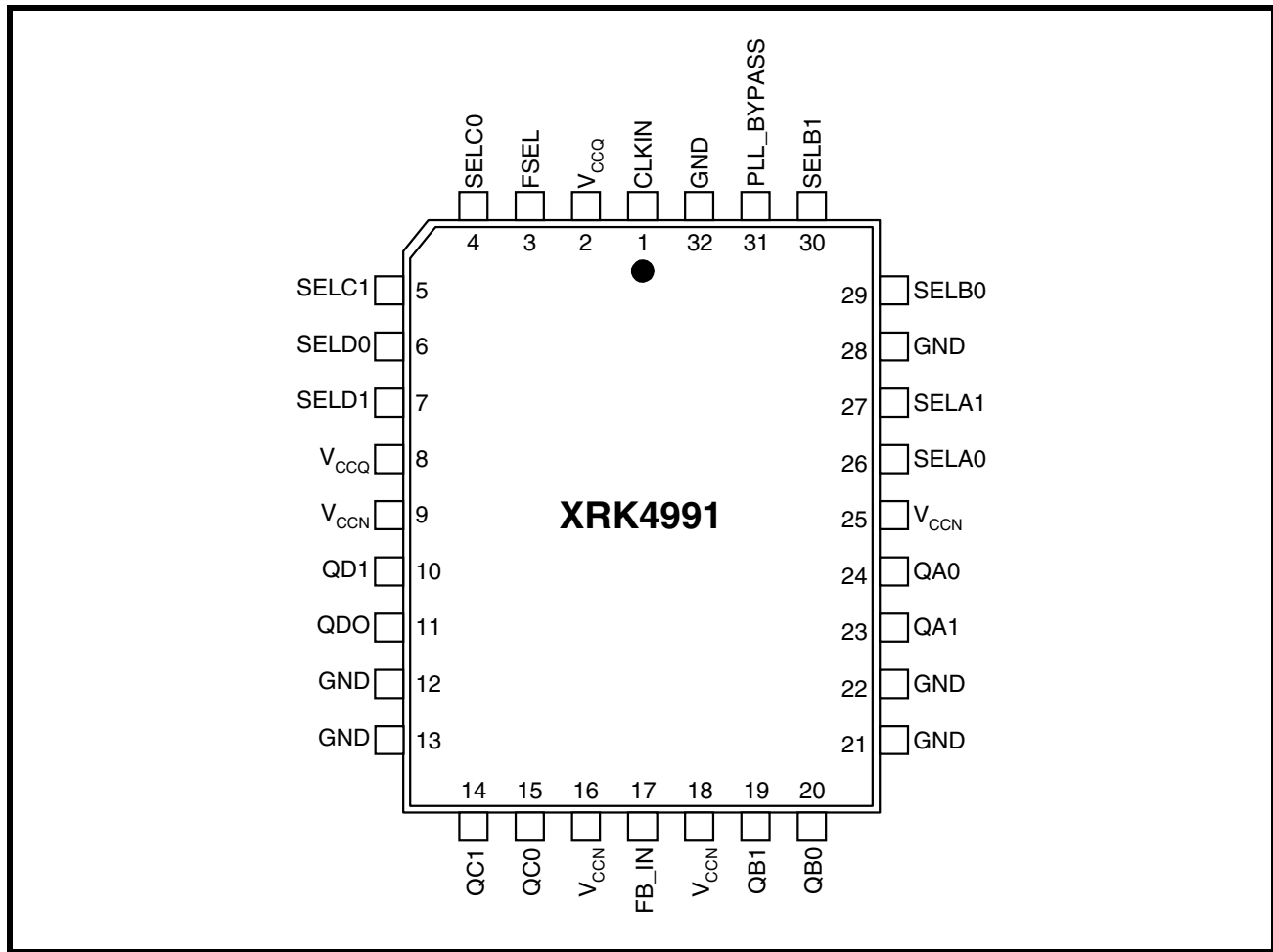

PIN DESCRIPTIONS

PIN NAME	PIN #	TYPE	DESCRIPTION
CLKIN	1	I	Reference clock input.
FB_IN	17	I	PLL's feedback input. (Normally connected to one of the eight outputs)
FSEL	3	I	Tri-level frequency range select. See Table 1
PLL_BYPASS	31	I	Tri-level select. See PLL_BYPASS section.
SELA0 SELA1	26 27	I	Tri-level select inputs for Bank A outputs (QA0, QA1). See Table 2.
SELB0 SELB1	29 30	I	Tri-level select inputs for Bank B outputs (QB0, QB1). See Table 2.
SELC0 SELC1	4 5	I	Tri-level select inputs for Bank C outputs (QC0, QC1). See Table 2.
SELD0 SELD1	6 7	I	Tri-level select inputs for Bank D outputs (QD0, QD1). See Table 2.
QA0 QA1	24 23	O	Bank A output pair. See Table 2.
QB0 QB1	20 19	O	Bank B output pair. See Table 2.
QC0 QC1	15 14	O	Bank C output pair. See Table 2.
QD0 QD1	11 10	O	Bank D output pair. See Table 2.
V _{CCN}	9 16 18 25	PWR	Power supply for output drivers.
V _{CCQ}	2 8	PWR	Power supply for internal circuitry.
GND	12 13 21 22 28 32	PWR	Ground.

TABLE 1: FREQUENCY RANGE SELECT AND t_U CALCULATION ^[1]

FSEL ^[2]	f_{NOM} (MHz)		$t_U = 1 / (f_{NOM} \times N)$ WHERE N =	APPROXIMATE FREQUENCY (MHz) AT WHICH $t_U = 1.0ns$
	MIN	MAX		
LOW	15	30	44	22.7
MID	25	50	26	38.5
HIGH ^[3]	40	85	16	62.5

SKEW SELECT CONTROL

The skew select control consists of four independent banks. Each bank has two low-skew, high-fanout drivers (Qx0, Qx1), and two corresponding tri-level function select (SELx0, SELx1) inputs. The nine possible output states for each bank are shown in Table 2 as determined by each bank’s select inputs. All timing measurements are made with respect to the CLKIN input with the output connected to the FB_IN input configured for 0 t_U operation.

TABLE 2: PROGRAMMABLE SKEW CONFIGURATIONS ^[1]

FUNCTION SELECT INPUTS		OUTPUT FUNCTIONS		
SELx1	SELx0	QA[1:0], QB[1:0]	QC[1:0]	QD[1:0]
LOW	LOW	-4 t_U	$\div 2$	$\div 2$
LOW	MID	-3 t_U	-6 t_U	-6 t_U
LOW	HIGH	-2 t_U	-4 t_U	-4 t_U
MID	LOW	-1 t_U	-2 t_U	-2 t_U
MID	MID	0 t_U	0 t_U	0 t_U
MID	HIGH	+1 t_U	+2 t_U	+2 t_U
HIGH	LOW	+2 t_U	+4 t_U	+4 t_U
HIGH	MID	+3 t_U	+6 t_U	+6 t_U
HIGH	HIGH	+4 t_U	$\div 4$	Inverted

NOTES:

1. For all tri-level (three-state) inputs, HIGH indicates a connection to V_{CC} , LOW indicates a connection to GND, and MID indicates an open connection. Internal termination circuitry holds an unconnected input to $V_{CC}/2$.
2. The level to be set on FSEL is determined by the “normal” operating frequency (f_{NOM}) of the PLL. Nominal frequency (f_{NOM}) always appears at QA0 and the other outputs when they are operated in their undivided modes (see Table 2). The frequency appearing at the CLKIN and FB_IN inputs will be f_{NOM} when the output connected to FB_IN is undivided. The frequency of the CLKIN and FB_IN inputs will be $f_{NOM} \div 2$ or $f_{NOM} \div 4$ when the part is configured for a frequency multiplication.
3. When the FSEL pin is selected HIGH, the CLKIN input must not transition upon power-up until V_{CC} has reached 2.8V.

FIGURE 3. TYPICAL OUTPUTS WITH FB_IN CONNECTED TO A ZERO-SKEW OUTPUT

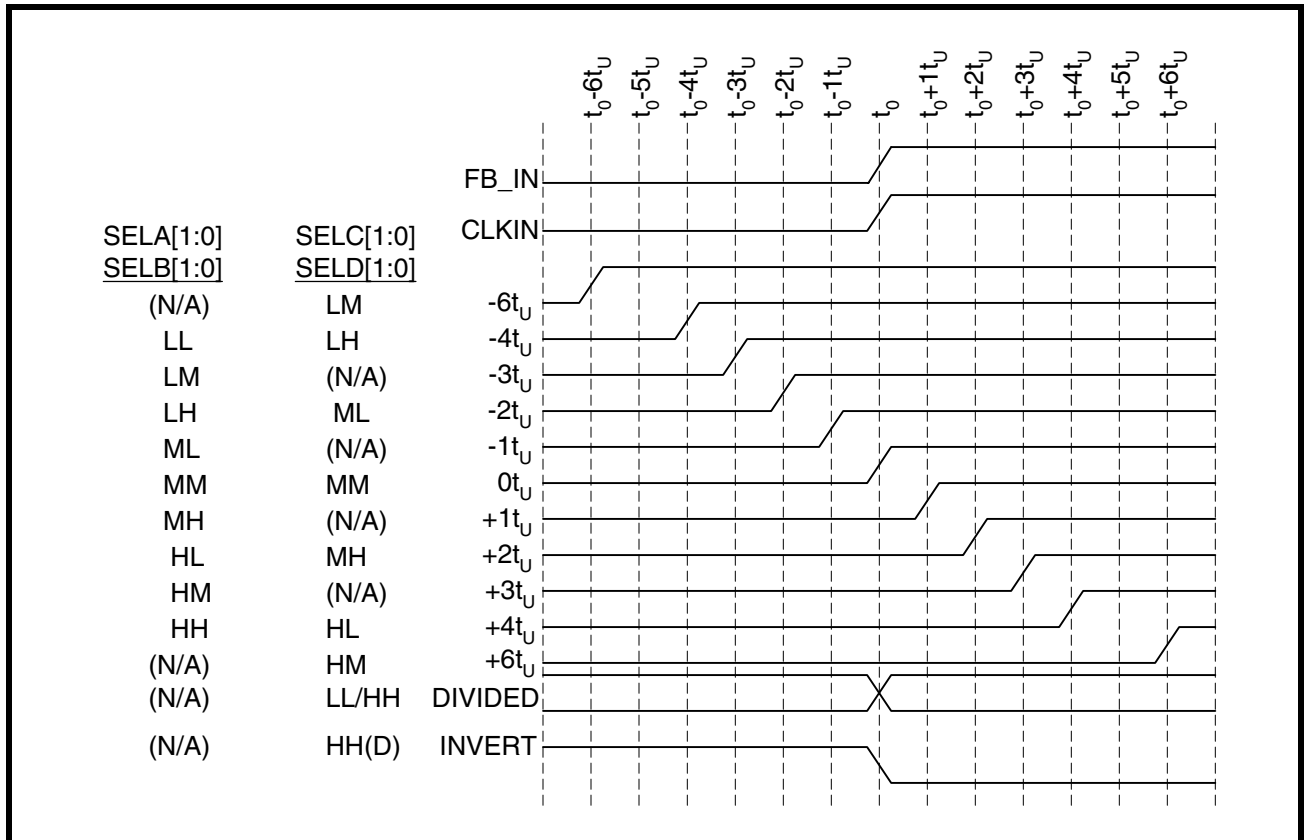

PLL_BYPASS

The PLL_BYPASS input is a tri-level input. In normal system operation, this pin is connected to ground.

In normal operation (tied LOW) all outputs will function based only on the connection of their own function select inputs (SELx[1:0]) and the waveform characteristics of the PLL.

If the PLL_BYPASS input is forced to its MID or HIGH state the device will operate in PLL bypass mode, with the phase locked loop disconnected, and CLKIN waveforms will directly control all outputs. Relative output to output timing is controlled by the SELx[1:0], the same as in normal mode.

ELECTRICAL SPECIFICATIONS

ABSOLUTE MAXIMUM RATINGS

Storage Temperature	-65°C to +150°C
Ambient Temperature with Power Applied	-55°C to +125°C
Supply Voltage to Ground Potential	-0.5V to +7.0V
DC Input Voltage	-0.5V to +7.0V
Output Current into Outputs (LOW)	64 mA
Static Discharge Voltage (per MIL-STD-883, Method 3015)	>3000V
Latch-Up Current.	>200 mA

OPERATING RANGE

RANGE	AMBIENT TEMPERATURE	VCC
Industrial	-40°C to +85°C	3.3 ± 10%
Commercial	0°C to +70°C	3.3 ± 10%

ELECTRICAL CHARACTERISTICS OVER THE 3.3V ± 10% OPERATING RANGE

SYMBOL	DESCRIPTION	MIN	MAX	UNIT	CONDITION
V _{OH}	Output HIGH Voltage	2.4		V	V _{CC} = Min., I _{OH} = -18mA
V _{OL}	Output LOW Voltage		0.45	V	V _{CC} = Min., I _{OL} = 35mA
V _{IH}	Input HIGH Voltage	2.0	V _{CC}	V	(CLKIN and FB_IN inputs only)
V _{IL}	Input LOW Voltage	-0.5	0.8	V	
V _{IHH}	tri-level Input HIGH Voltage (FSEL, SELx[1:0], Test) ^[4]	0.87*V _{CC}	V _{CC}	V	Min. ≤ V _{CC} ≤ Max.
V _{IMM}	tri-level Input MID Voltage (FSEL, SELx[1:0], Test) ^[4]	0.47*V _{CC}	0.53 * V _{CC}	V	Min. ≤ V _{CC} ≤ Max.
V _{ILL}	tri-level Input LOW Voltage (FSEL, SELx[1:0], Test) ^[4]	0.0	0.13 * V _{CC}	V	Min. ≤ V _{CC} ≤ Max.
I _{IH}	Input HIGH Leakage Current (CLKIN and FB_IN inputs only)		20	μA	V _{CC} = Max., V _{IN} = Max.
I _{IL}	Input LOW Leakage Current (CLKIN and FB_IN inputs only)	-20		μA	V _{CC} = Max., V _{IN} = 0.4V
I _{IHH}	Input HIGH Current (FSEL, SELx[1:0], Test)		200	μA	V _{IN} = V _{CC}
I _{IMM}	Input MID Current (FSEL, SELx[1:0], Test)	-50	50	μA	V _{IN} = V _{CC} /2
I _{ILL}	Input LOW Current (FSEL, SELx[1:0], Test)		-200	μA	V _{IN} = GND

ELECTRICAL CHARACTERISTICS OVER THE 3.3V ± 10% OPERATING RANGE

SYMBOL	DESCRIPTION	MIN	MAX	UNIT	CONDITION
I _{OS}	Short Circuit Current ^[5]		-200	mA	V _{CC} = Max, V _{OUT} = GND (25° only)
I _{CCQ}	Operating Current Used by Internal Circuitry	Com'l		95	mA V _{CCN} = V _{CCQ} = Max., All Inputs Selects Open
		Ind		100	
I _{CCN}	Output Buffer Current per Output Pair ^[6]		19	mA	V _{CCN} = V _{CCQ} = Max., I _{OUT} = 0 mA Inputs Selects Open, f _{MAX}
PD	Power Dissipation per Output Pair ^[7]		104	mW	V _{CCN} = V _{CCQ} = Max., I _{OUT} = 0 mA Input Selects Open, f _{MAX}

CAPACITANCE^[8]

SYMBOL	DESCRIPTION	MAX.	UNIT	CONDITION
C _{IN}	Input Capacitance	10	pF	T _A = 25°C, f=1MHz, V _{CC} =3.3V

NOTES:

- These inputs are normally wired to V_{CC}, GND or left unconnected (actual threshold voltages vary as a percentage of V_{CC}). Internal termination resistors hold unconnected inputs at V_{CC}/2. If these inputs are switched, the function and timing of the outputs may glitch and the PLL may require an additional t_{LOCK} time before all data sheet limits are achieved.
- XRK4991 should be tested one output at a time, output shorted for less than one second, less than 10% duty cycle. Room temperature only.
- Total output current per output pair can be approximated by the following expression that includes device current plus load current:

$$\text{XRK4991: } I_{CCN} = \{(4+0.11F) + [(835-3F)/Z + (.0022FC)]N\} \times 1.1$$

Where:

F = frequency in MHz

C = capacitive load in pF

Z = line impedance in ohms

N = number of loaded outputs; 0, 1, or 2

- Total power dissipation per output pair can be approximated by the following expression that includes device power dissipation plus power dissipation due to the load circuit:

$$PD = \{(22 + 0.61F) + [(1550 + 2.7F)/Z] + .0125FC\}N \times 1.1$$

See note 6 for variable definition.

- Applies to CLKIN and FB_IN inputs only.

FIGURE 4. AC TEST LOAD

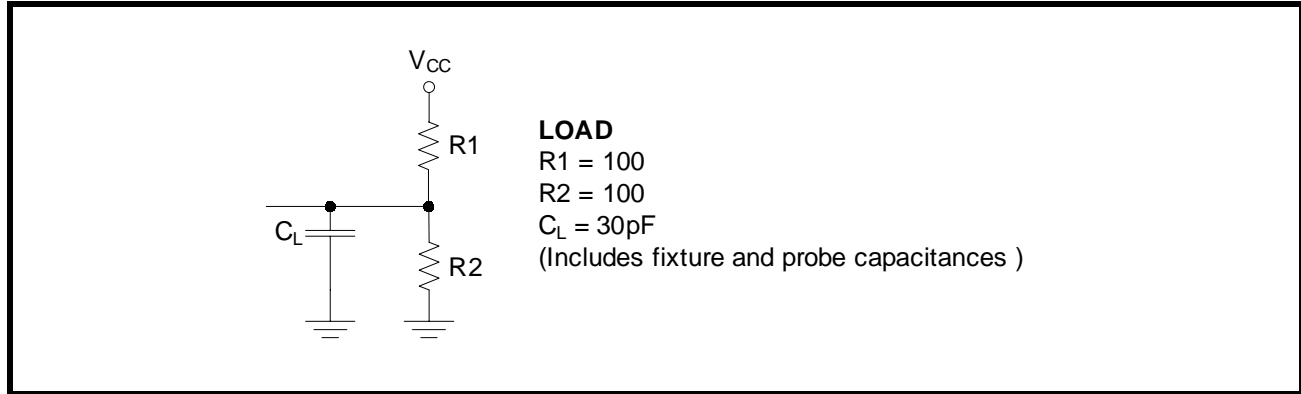
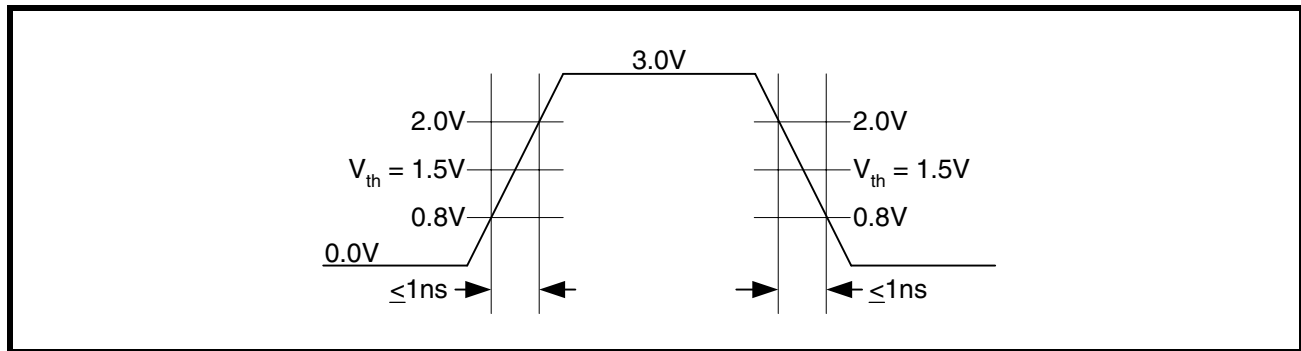

FIGURE 5. INPUT TEST WAVEFORM



SWITCHING CHARACTERISTICS OVER THE OPERATING RANGE [2,9]

SYMBOL	DESCRIPTION	MIN	MAX	UNIT	
f _{NOM}	Operating Clock Frequency in MHz	FSEL = LOW [1, 2]	15	30	MHz
		FSEL = MID [1, 2]	25	50	
		FSEL = HIGH [1, 2, 3]	40	85	

SWITCHING CHARACTERISTICS OVER THE 3.3V ± 10% OPERATING RANGE [2,9]

SYMBOL	DESCRIPTION	XRK4991-2			XRK4991-5			XRK4991-7			UNIT
		MIN	TYP	MAX	MIN	TYP	MAX	MIN	TYP	MAX	
t _{RPWH}	CLKIN Pulse Width HIGH	4			4			4			ns
t _{RPWL}	CLKIN Pulse Width LOW	4			4			4			ns
t _U	Programmable Skew Unit	See Table 1									
t _{SKEWPR}	Zero Output Matched-Pair Skew (Qx[1:0]) [10, 11]		0.05	0.2		0.1	0.25		0.1	0.25	ns
t _{SKEW0}	Zero Output Skew (All Outputs) [10, 12]		0.1	0.25		0.25	0.5		0.3	0.75	ns
t _{SKEW1}	Output Skew (Rise-Rise, Fall-Fall, Same Class Outputs) [10, 13]		0.25	0.5		0.6	0.7		0.6	1	ns
t _{SKEW2}	Output Skew (Rise-Fall, Nominal-Inverted, Divided-Divided) [10, 13]		0.3	1		0.5	1		1	1.5	ns
t _{SKEW3}	Output Skew (Rise-Rise, Fall-Fall, Different Class Outputs) [10, 13]		0.25	0.5		0.5	0.7		0.7	1.2	ns
t _{SKEW4}	Output Skew (Rise-Fall, Nominal-Divided, Divided-Inverted) [10, 13]		0.5	0.9		0.5	1		1.2	1.7	ns
t _{DEV}	Device-to-Device Skew [14, 15]			0.75			1.25			1.65	ns
t _{PD}	Propagation Delay, CLKIN Rise to FB_IN Rise	-0.25	0	0.25	-0.5	0	0.5	-0.7	0	0.7	ns
t _{ODCV}	Output Duty Cycle Variation [16]	-0.65	0	0.65	-1	0	1	-1.2	0	1.2	ns
t _{PWH}	Output HIGH Time Deviation from 50% [17]			2.0			2.5			3	ns
t _{PWL}	Output LOW Time Deviation from 50% [17]			1.5			3			3.5	ns
t _{ORISE}	Output Rise Time [17, 18]	0.15	1	1.2	0.15	1	1.5	0.15	1.5	2.5	ns
t _{OFALL}	Output Fall Time [17, 18]	0.15	1	1.2	0.15	1	1.5	0.15	1.5	2.5	ns
t _{LOCK}	PLL Lock Time [19]			0.5			0.5			0.5	ms
t _{JR}	Cycle-to-Cycle Output Jitter	RMS [14]		25			25			25	ps
		Peak-to-Peak [14]		200			200			200	

NOTES:

9. Test measurement levels for the XRK4991 are TTL levels (1.5V to 1.5V). Test conditions assume signal transition times of 2 ns or less and output loading as shown in the AC Test Loads and Waveforms unless otherwise specified.
10. SKEW is defined as the time between the earliest and the latest output transition among all outputs for which the same t_U delay has been selected when all are loaded with 30pF and terminated with 50Ω to V_{CC}/2 (XRK4991).

PACKAGE DIMENSIONS

**32 LEAD PLASTIC LEADED CHIP CARRIER
(PLCC)
Rev. 1.00**

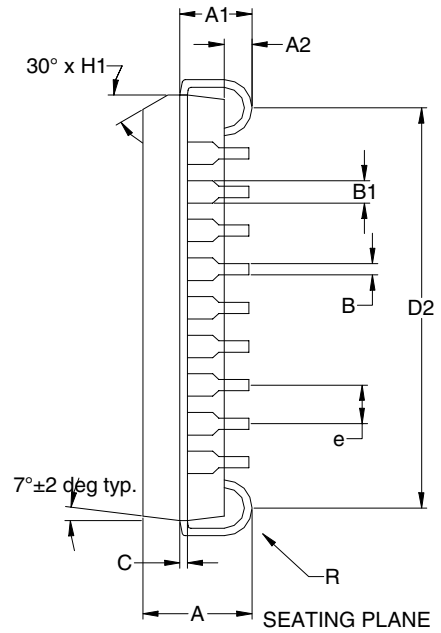
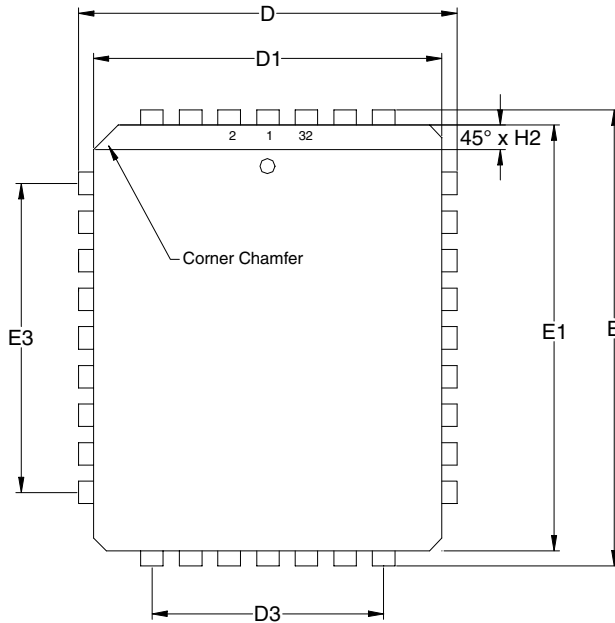

SYMBOL	INCHES		MILLIMETERS	
	MIN	MAX	MIN	MAX
A	0.120	0.140	3.05	3.56
A1	0.075	0.095	1.91	2.41
A2	0.020	---	0.51	---
B	0.013	0.021	0.33	0.53
B1	0.026	0.032	0.66	0.81
C	0.008	0.013	0.19	0.32
D	0.485	0.495	12.33	12.58
D1	0.448	0.454	11.39	11.54
D2	0.400	0.440	10.17	11.18
D3	0.300 typ.		7.62 typ.	
E	0.585	0.595	14.87	15.11
E1	0.545	0.557	13.85	14.15
E2	0.500	0.540	12.71	13.72
E3	0.400 typ.		10.16 typ.	
e	0.050 BSC		1.27 BSC	
H1	0.023	0.029	0.58	0.74
H2	0.042	0.048	1.07	1.22
R	0.025	0.045	0.64	1.14

Note: The control dimension is in inches.

REVISION HISTORY

REVISION #	DATE	DESCRIPTION
1.0.0	June 17, 2005	Initial Release to Production
1.0.1	October 5, 2005	Product ordering information: Remove "F" product numbers and Lead Free column.

NOTICE

EXAR Corporation reserves the right to make changes to the products contained in this publication in order to improve design, performance or reliability. EXAR Corporation assumes no responsibility for the use of any circuits described herein, conveys no license under any patent or other right, and makes no representation that the circuits are free of patent infringement. Charts and schedules contained here in are only for illustration purposes and may vary depending upon a user's specific application. While the information in this publication has been carefully checked; no responsibility, however, is assumed for inaccuracies.

EXAR Corporation does not recommend the use of any of its products in life support applications where the failure or malfunction of the product can reasonably be expected to cause failure of the life support system or to significantly affect its safety or effectiveness. Products are not authorized for use in such applications unless EXAR Corporation receives, in writing, assurances to its satisfaction that: (a) the risk of injury or damage has been minimized; (b) the user assumes all such risks; (c) potential liability of EXAR Corporation is adequately protected under the circumstances.

Copyright 2005 EXAR Corporation

Datasheet October 2005.

Reproduction, in part or whole, without the prior written consent of EXAR Corporation is prohibited.