

National Semiconductor is now part of
Texas Instruments.

Search <http://www.ti.com/> for the latest technical
information and details on our current products and services.

ADC11L066

11-Bit, 66 MSPS, 450 MHz Bandwidth A/D Converter with Internal Sample-and-Hold

General Description

The ADC11L066 is a monolithic CMOS analog-to-digital converter capable of converting analog input signals into 11-bit digital words at 66 Megasamples per second (MSPS), minimum, with typical operation possible up to 80 MSPS. This converter uses a differential, pipeline architecture with digital error correction and an on-chip sample-and-hold circuit to minimize die size and power consumption while providing excellent dynamic performance. A unique sample-and-hold stage yields a full-power bandwidth of 450 MHz. Operating on a single 3.3V power supply, this device consumes just 357 mW at 66 MSPS, including the reference current. The Power Down feature reduces power consumption to just 50 mW.

The differential inputs provide a full scale input swing equal to $\pm V_{REF}$ with the possibility of a single-ended input. Full use of the differential input is recommended for optimum performance. For ease of use, the buffered, high impedance, single-ended reference input is converted on-chip to a differential reference for use by the processing circuitry. Output data format is 11-bit offset binary.

This device is available in the 32-lead LQFP package and will operate over the industrial temperature range of -40°C to $+85^{\circ}\text{C}$.

Features

- Single supply operation
- Low power consumption
- Power down mode
- On-chip reference buffer

Key Specifications

| | |
|-----------------------------|---------------------------|
| ■ Resolution | 11 Bits |
| ■ Conversion Rate | 66 MSPS |
| ■ Full Power Bandwidth | 450 MHz |
| ■ DNL | ± 0.2 LSB (typ) |
| ■ INL | ± 0.5 LSB (typ) |
| ■ SNR ($f_{IN} = 10$ MHz) | 65 dB (typ) |
| ■ SFDR ($f_{IN} = 10$ MHz) | 78 dB (typ) |
| ■ Data Latency | 6 Clock Cycles |
| ■ Supply Voltage | $+3.3\text{V} \pm 300$ mV |
| ■ Power Consumption, 66 MHz | 357 mW (typ) |

Applications

- Ultrasound and Imaging
- Instrumentation
- Cellular Base Stations/Communications Receivers
- Sonar/Radar
- Wireless Local Loops
- Data Acquisition Systems
- DSP Front Ends

Connection Diagram

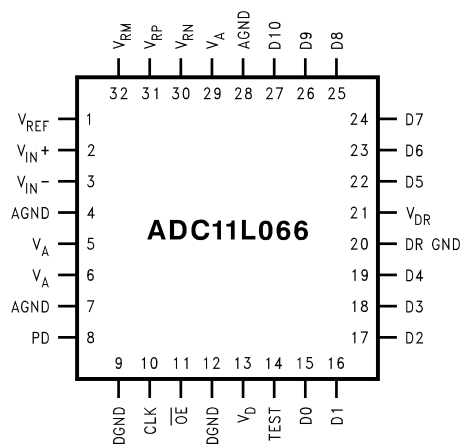

20050701

Ordering Information

| Industrial ($-40^{\circ}\text{C} \leq T_A \leq +85^{\circ}\text{C}$) | Package |
|--|---------------------------|
| ADC11L066CIVY | 32 Pin LQFP |
| ADC11L066CIVYX | 32 Pin LQFP Tape and Reel |

Block Diagram

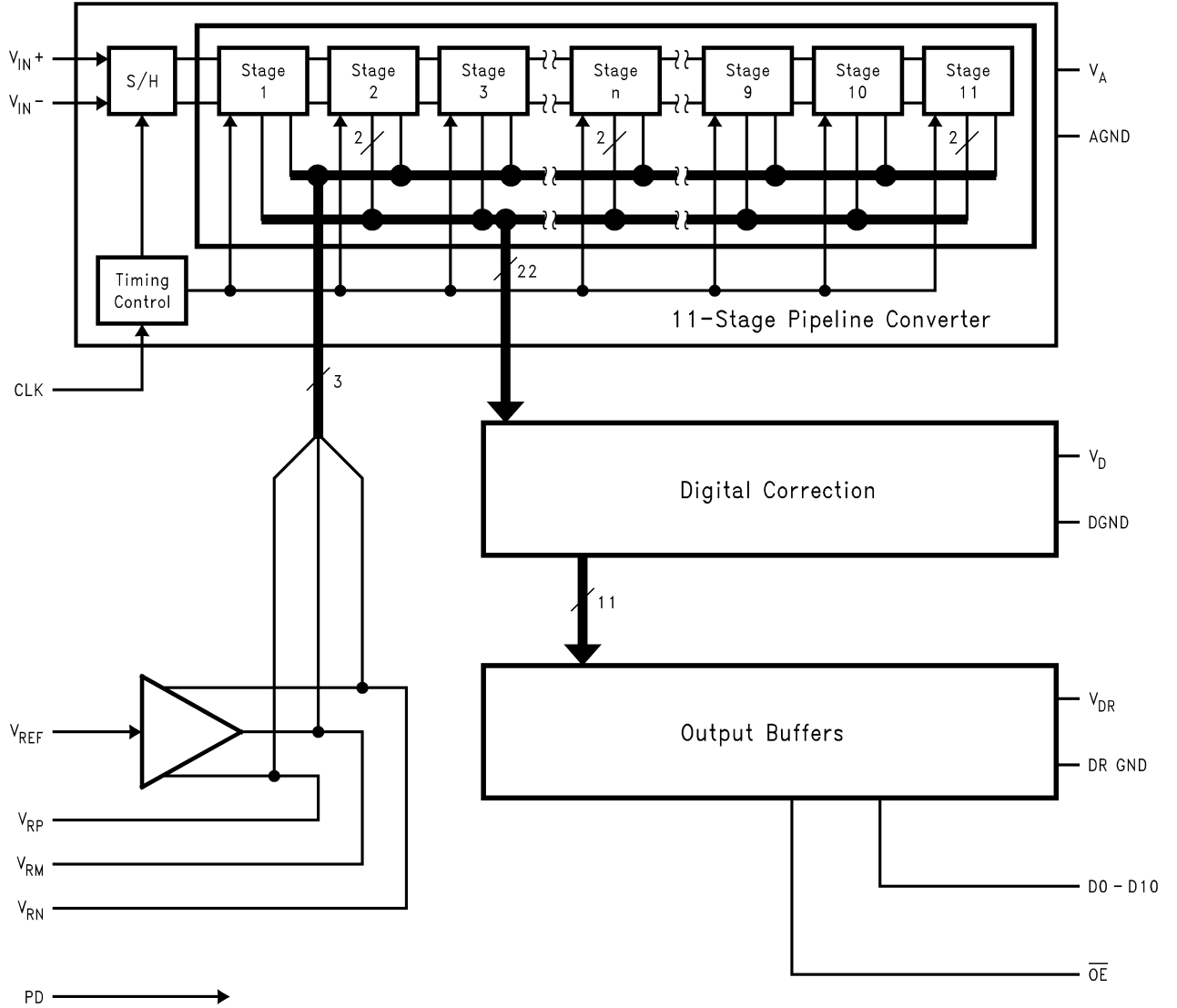

20050702

Pin Descriptions and Equivalent Circuits

| Pin No. | Symbol | Equivalent Circuit | Description |
|--------------------|-----------------|--------------------|---|
| ANALOG I/O | | | |
| 2 | V_{IN+} | | <p>Analogue signal Input pins. With a 1.0V reference voltage the differential input signal level is 2.0 V_{P-P}. The V_{IN-} pin may be connected to V_{CM} for single-ended operation, but a differential input signal is required for best performance.</p> |
| 3 | V_{IN-} | | |
| 1 | V_{REF} | | <p>Reference input. This pin should be bypassed to AGND with a 0.1 µF monolithic capacitor. V_{REF} is 1.0V nominal and should be between 0.8V and 1.5V.</p> |
| 31 | V_{RP} | | <p>These pins are high impedance reference bypass pins only. Connect a 0.1 µF capacitor from each of these pins to AGND. DO NOT connect anything else to these pins.</p> |
| 32 | V_{RM} | | |
| 30 | V_{RN} | | |
| DIGITAL I/O | | | |
| 10 | CLK | | <p>Digital clock input. The range of frequencies for this input is 10 MHz to 80 MHz (typical) with guaranteed performance at 66 MHz. The input is sampled on the rising edge of this input.</p> |
| 11 | \overline{OE} | | <p>\overline{OE} is the output enable pin that, when low, enables the TRI-STATE® data output pins. When this pin is high, the outputs are in a high impedance state.</p> |
| 8 | PD | | <p>PD is the Power Down input pin. When high, this input puts the converter into the power down mode. When this pin is low, the converter is in the active mode.</p> |

Pin Descriptions and Equivalent Circuits (Continued)

| Pin No. | Symbol | Equivalent Circuit | Description |
|----------------------|----------|--------------------|---|
| 15–19, 22–27 | D0–D10 | | Digital data output pins that make up the 11-bit conversion results. D0 is the LSB, while D10 is the MSB of the offset binary output word. |
| ANALOG POWER | | | |
| 5, 6, 29 | V_A | | Positive analog supply pins. These pins should be connected to a quiet +3.3V source and bypassed to AGND with 0.1 μF monolithic capacitors located within 1 cm of these power pins, and with a 10 μF capacitor. |
| 4, 7, 28 | AGND | | The ground return for the analog supply. |
| DIGITAL POWER | | | |
| 13 | V_D | | Positive digital supply pin. This pin should be connected to the same quiet +3.3V source as is V_A and bypassed to DGND with a 0.1 μF monolithic capacitor in parallel with a 10 μF capacitor, both located within 1 cm of the power pin. |
| 9, 12 | DGND | | The ground return for the digital supply. |
| 21 | V_{DR} | | Positive digital supply pin for the ADC11L066's output drivers. This pin should be connected to a voltage source of +1.8V to V_D and bypassed to DR GND with a 0.1 μF monolithic capacitor. If the supply for this pin is different from the supply used for V_A and V_D , it should also be bypassed with a 10 μF tantalum capacitor. The voltage at this pin should never exceed the voltage on V_D by more than 300 mV. All bypass capacitors should be located within 1 cm of the supply pin. |
| 20 | DR GND | | The ground return for the digital supply for the ADC11L066's output drivers. This pin should be connected to the system digital ground, but not be connected in close proximity to the ADC11L066's DGND or AGND pins. See Section 5.0 (Layout and Grounding) for more details. |
| OTHER | | | |
| 14 | TEST | | This pin is internally tied to DGND. It may be connected to DGND, or left floating. |

Absolute Maximum Ratings (Notes 1,

2)

If Military/Aerospace specified devices are required, please contact the National Semiconductor Sales Office/Distributors for availability and specifications.

| | |
|---|----------------------------------|
| V_A, V_D, V_{DR} | 4.2V |
| $ V_A - V_D $ | ≤ 100 mV |
| Voltage on Any Pin | -0.3V to V_A or V_D +0.3V |
| Input Current at Any Pin (Note 3) | ± 25 mA |
| Package Input Current (Note 3) | ± 50 mA |
| Package Dissipation at $T_A = 25^\circ\text{C}$ | See (Note 4) |
| ESD Susceptibility | |
| Human Body Model (Note 5) | 2500V |
| Machine Model (Note 5) | 250V |
| Soldering Temperature, | |
| Infrared, 10 sec. (Note 6) | 235°C |
| Storage Temperature | -65°C to +150°C |

Operating Ratings (Notes 1, 2)

| | |
|-----------------------------------|---|
| Operating Temperature | $-40^\circ\text{C} \leq T_A \leq +85^\circ\text{C}$ |
| Supply Voltage (V_A, V_D) | +3.0V to +3.60V |
| Output Driver Supply (V_{DR}) | +1.8V to V_D |
| V_{REF} Input | 0.8V to 1.5V |
| CLK, PD, \overline{OE} | -0.05V to ($V_D + 0.05$ V) |
| V_{IN} Input | -0V to ($V_A - 0.5$ V) |
| V_{CM} | 0.5V to ($V_A - 1.5$ V) |
| IAGND-DGNDI | ≤ 100 mV |

Converter Electrical Characteristics

Unless otherwise specified, the following specifications apply for AGND = DGND = DR GND = 0V, $V_A = V_D = +3.3$ V, $V_{DR} = +2.5$ V, PD = 0V, $V_{REF} = +1.0$ V, $V_{CM} = 1.0$ V, $f_{CLK} = 66$ MHz, $t_r = t_f = 2$ ns, $C_L = 15$ pF/pin.

Boldface limits apply for $T_J = T_{MIN}$ to T_{MAX} : all other limits $T_J = 25^\circ\text{C}$ (Notes 7, 8, 9, 10)

| Symbol | Parameter | Conditions | Typical (Note 10) | Limits (Note 10) | Units (Limits) |
|---|--|-------------------------------------|----------------------|-----------------------------|-------------------|
| STATIC CONVERTER CHARACTERISTICS | | | | | |
| | Resolution with No Missing Codes | | | 11 | Bits |
| INL | Integral Non Linearity (Note 11) | | ± 0.5 | 1.8 | LSB (max) |
| | | | | -1.7 | LSB (min) |
| DNL | Differential Non Linearity | | ± 0.2 | 0.6 | LSB (max) |
| | | | | -0.8 | LSB (min) |
| GE | Gain Error | Positive Error | -0.5 | 2.9 | %FS (max) |
| | | | | -4.0 | %FS (min) |
| | | Negative Error | -0.2 | 4.8 | %FS (max) |
| | | | | -4.1 | %FS (min) |
| | Offset Error ($V_{IN+} = V_{IN-}$) | | -0.15 | ± 1.3 | %FS (max) |
| | Under Range Output Code | | 0 | 0 | |
| | Over Range Output Code | | 2047 | 2047 | |
| REFERENCE AND ANALOG INPUT CHARACTERISTICS | | | | | |
| V_{CM} | Common Mode Input Voltage | | 0.5 | | V (min) |
| | | | 1.5 | | V (max) |
| C_{IN} | V_{IN} Input Capacitance (each pin to GND) | $V_{IN} = 1.0$ Vdc + 1 V_{P-P} | (CLK LOW) | 8 | pF |
| | | | (CLK HIGH) | 7 | pF |
| V_{REF} | Reference Voltage (Note 13) | | 0.8 | | V (min) |
| | | | 1.5 | | V (max) |
| | Reference Input Resistance | | 100 | | M Ω (min) |

Converter Electrical Characteristics (Continued)

Unless otherwise specified, the following specifications apply for AGND = DGND = DR GND = 0V, $V_A = V_D = +3.3V$, $V_{DR} = +2.5V$, $V_{PD} = 0V$, $V_{REF} = +1.0V$, $V_{CM} = 1.0V$, $f_{CLK} = 66\text{ MHz}$, $t_r = t_f = 2\text{ ns}$, $C_L = 15\text{ pF/pin}$.

Boldface limits apply for $T_J = T_{MIN}$ to T_{MAX} : all other limits $T_J = 25^\circ\text{C}$ (Notes 7, 8, 9, 10)

| Symbol | Parameter | Conditions | Typical (Note 10) | Limits (Note 10) | Units (Limits) | |
|--|------------------------------|--|----------------------|---------------------|-------------------|------------|
| DYNAMIC CONVERTER CHARACTERISTICS | | | | | | |
| BW | Full Power Bandwidth | 0 dBFS Input, Output at -3 dB | 450 | | MHz | |
| SNR | Signal-to-Noise Ratio | $f_{IN} = 10\text{ MHz}$, Differential $V_{IN} = -0.5\text{ dBFS}$ | 85°C | 65 | 62.8 | dB (min) |
| | | | 25°C | | 63.4 | dB (min) |
| | | | -40°C | | 62.5 | dB (min) |
| | | $f_{IN} = 25\text{ MHz}$, Differential $V_{IN} = -0.5\text{ dBFS}$ | | 64 | | dB |
| | | $f_{IN} = 150\text{ MHz}$, Differential $V_{IN} = -6\text{ dBFS}$ | 85°C | 56 | 52.8 | dB (min) |
| 25°C | 53.5 | | dB (min) | | | |
| -40°C | 52.1 | | dB (min) | | | |
| $f_{IN} = 240\text{ Hz}$, Differential $V_{IN} = -6\text{ dBFS}$ | | 52 | | dB | | |
| SINAD | Signal-to-Noise & Distortion | $f_{IN} = 10\text{ MHz}$, Differential $V_{IN} = -0.5\text{ dBFS}$ | 85°C | 64 | 62.1 | dB (min) |
| | | | 25°C | | 62.4 | dB (min) |
| | | | -40°C | | 61.2 | dB (min) |
| | | $f_{IN} = 25\text{ MHz}$, Differential $V_{IN} = -0.5\text{ dBFS}$ | | 63 | | dB |
| | | $f_{IN} = 150\text{ MHz}$, Differential $V_{IN} = -6\text{ dBFS}$ | 85°C | 55 | 52.3 | dB (min) |
| 25°C | 52.7 | | dB (min) | | | |
| -40°C | 50.6 | | dB (min) | | | |
| $f_{IN} = 240\text{ Hz}$, Differential $V_{IN} = -6\text{ dBFS}$ | | 50 | | dB | | |
| ENOB | Effective Number of Bits | $f_{IN} = 10\text{ MHz}$, Differential $V_{IN} = -0.5\text{ dBFS}$ | 85°C | 10.31 | 10.02 | Bits(min) |
| | | | 25°C | | 10.07 | |
| | | | -40°C | | 9.80 | |
| | | $f_{IN} = 25\text{ MHz}$, Differential $V_{IN} = -0.5\text{ dBFS}$ | | 10.18 | | Bits |
| | | $f_{IN} = 150\text{ MHz}$, Differential $V_{IN} = -6\text{ dBFS}$ | 85°C | 8.76 | 8.36 | Bits (min) |
| 25°C | 8.46 | | | | | |
| -40°C | 8.06 | | | | | |
| $f_{IN} = 240\text{ Hz}$, Differential $V_{IN} = -6\text{ dBFS}$ | | 8.05 | | Bits | | |

Converter Electrical Characteristics (Continued)

Unless otherwise specified, the following specifications apply for AGND = DGND = DR GND = 0V, $V_A = V_D = +3.3V$, $V_{DR} = +2.5V$, $PD = 0V$, $V_{REF} = +1.0V$, $V_{CM} = 1.0V$, $f_{CLK} = 66\text{ MHz}$, $t_r = t_f = 2\text{ ns}$, $C_L = 15\text{ pF/pin}$.

Boldface limits apply for $T_J = T_{MIN}$ to T_{MAX} : all other limits $T_J = 25^\circ\text{C}$ (Notes 7, 8, 9, 10)

| Symbol | Parameter | Conditions | | Typical (Note 10) | Limits (Note 10) | Units (Limits) |
|--|----------------------------|--|----------|----------------------|---------------------|-------------------|
| 2nd Harm | Second Harmonic Distortion | $f_{IN} = 10\text{ MHz}$, Differential $V_{IN} =$ -0.5 dBFS | 85°C | -78 | -68.7 | dB (max) |
| | | | 25°C | | -69.5 | dB (max) |
| | | | -40°C | | -69.7 | dB (max) |
| | | $f_{IN} = 25\text{ MHz}$, Differential $V_{IN} =$ -0.5 dBFS | | -86 | | dB |
| | | $f_{IN} = 150\text{ MHz}$, Differential $V_{IN} =$ -6 dBFS | 85°C | -67 | -60.6 | dB (max) |
| | | | 25°C | | -62.0 | dB (max) |
| -40°C | -58.3 | | dB (max) | | | |
| $f_{IN} = 240\text{ Hz}$, Differential $V_{IN} =$ -6 dBFS | | -62 | | dB | | |
| 3rd Harm | Third Harmonic Distortion | $f_{IN} = 10\text{ MHz}$, Differential $V_{IN} =$ -0.5 dBFS | 85°C | -91 | -72.8 | dB (max) |
| | | | 25°C | | -76.8 | dB (max) |
| | | | -40°C | | -67.1 | dB (max) |
| | | $f_{IN} = 25\text{ MHz}$, Differential $V_{IN} =$ -0.5 dBFS | | -80 | | dB |
| | | $f_{IN} = 150\text{ MHz}$, Differential $V_{IN} =$ -6 dBFS | 85°C | -77 | -69.8 | dB (max) |
| | | | 25°C | | -69.0 | dB (max) |
| -40°C | -66.0 | | dB (max) | | | |
| $f_{IN} = 240\text{ Hz}$, Differential $V_{IN} =$ -6 dBFS | | -74 | | dB | | |
| THD | Total Harmonic Distortion | $f_{IN} = 10\text{ MHz}$, Differential $V_{IN} =$ -0.5 dBFS | 85°C | -74 | -68.0 | dB (max) |
| | | | 25°C | | -67.0 | dB (max) |
| | | | -40°C | | -64.3 | dB (max) |
| | | $f_{IN} = 25\text{ MHz}$, Differential $V_{IN} =$ -0.5 dBFS | | -73 | | dB |
| | | $f_{IN} = 150\text{ MHz}$, Differential $V_{IN} =$ -6 dBFS | 85°C | -62 | -56.6 | dB (max) |
| | | | 25°C | | -57.2 | dB (max) |
| -40°C | -54.1 | | dB (max) | | | |
| $f_{IN} = 240\text{ Hz}$, Differential $V_{IN} =$ -6 dBFS | | -55 | | dB | | |

Converter Electrical Characteristics (Continued)

Unless otherwise specified, the following specifications apply for AGND = DGND = DR GND = 0V, $V_A = V_D = +3.3V$, $V_{DR} = +2.5V$, PD = 0V, $V_{REF} = +1.0V$, $V_{CM} = 1.0V$, $f_{CLK} = 66\text{ MHz}$, $t_r = t_f = 2\text{ ns}$, $C_L = 15\text{ pF/pin}$.

Boldface limits apply for $T_J = T_{MIN}$ to T_{MAX} : all other limits $T_J = 25^\circ\text{C}$ (Notes 7, 8, 9, 10)

| Symbol | Parameter | Conditions | Typical (Note 10) | Limits (Note 10) | Units (Limits) | |
|--------|---|---|----------------------|---------------------|-------------------|----------|
| SFDR | Spurious Free Dynamic Range | $f_{IN} = 10\text{ MHz}$, Differential $V_{IN} =$ -0.5 dBFS | 85°C | 78 | 68.7 | dB (min) |
| | | | 25°C | | 69.5 | dB (min) |
| | | | -40°C | | 68.7 | dB (min) |
| | | $f_{IN} = 25\text{ MHz}$, Differential $V_{IN} =$ -0.5 dBFS | | 77 | | dB |
| | | $f_{IN} = 150\text{ MHz}$, Differential $V_{IN} =$ -6 dBFS | 85°C | 67 | 60.6 | dB (min) |
| | 25°C | 62.0 | dB (min) | | | |
| | -40°C | 58.3 | dB (min) | | | |
| | $f_{IN} = 240\text{ Hz}$, Differential $V_{IN} =$ -6 dBFS | | 62 | | dB | |

DC and Logic Electrical Characteristics

Unless otherwise specified, the following specifications apply for AGND = DGND = DR GND = 0V, $V_A = V_D = +3.3V$, $V_{DR} = +2.5V$, PD = 0V, $V_{REF} = +1.0V$, $V_{CM} = 1.0V$, $f_{CLK} = 66\text{ MHz}$, $t_r = t_f = 2\text{ ns}$, $C_L = 15\text{ pF/pin}$.

Boldface limits apply for $T_J = T_{MIN}$ to T_{MAX} : all other limits $T_J = 25^\circ\text{C}$ (Notes 7, 8, 9, 10)

| Symbol | Parameter | Conditions | Typical (Note 10) | Limits (Note 10) | Units (Limits) |
|--|-------------------------------------|---|----------------------|-----------------------------------|-------------------|
| CLK, PD, \overline{OE} DIGITAL INPUT CHARACTERISTICS | | | | | |
| $V_{IN(1)}$ | Logical "1" Input Voltage | $V_D = 3.3V$ | | 2.0 | V (min) |
| $V_{IN(0)}$ | Logical "0" Input Voltage | $V_D = 3.3V$ | | 0.8 | V (max) |
| $I_{IN(1)}$ | Logical "1" Input Current | $V_{IN+}, V_{IN-} = 3.3V$ | 10 | | μA |
| $I_{IN(0)}$ | Logical "0" Input Current | $V_{IN+}, V_{IN-} = 0V$ | -10 | | μA |
| C_{IN} | Digital Input Capacitance | | 5 | | pF |
| D0–D11 DIGITAL OUTPUT CHARACTERISTICS | | | | | |
| $V_{OUT(1)}$ | Logical "1" Output Voltage | $I_{OUT} = -0.5\text{ mA}$ | | $V_{DR} - 0.18$ | V (min) |
| $V_{OUT(0)}$ | Logical "0" Output Voltage | $I_{OUT} = 1.6\text{ mA}$ | | 0.4 | V (max) |
| I_{OZ} | TRI-STATE Output Current | $V_{OUT} = 3.3V$ | 100 | | nA |
| | | $V_{OUT} = 0V$ | -100 | | nA |
| $+I_{SC}$ | Output Short Circuit Source Current | $V_{OUT} = 0V$ | -20 | | mA |
| $-I_{SC}$ | Output Short Circuit Sink Current | $V_{OUT} = 2.5V$ | 20 | | mA |
| POWER SUPPLY CHARACTERISTICS | | | | | |
| I_A | Analog Supply Current | PD Pin = DGND, $V_{REF} = 1.0V$ | 103 | 139 | mA (max) |
| | | PD Pin = V_{DR} | 4 | | |
| I_D | Digital Supply Current | PD Pin = DGND | 5.3 | 6.2 | mA (max) |
| | | PD Pin = V_{DR} | 2 | | |
| I_{DR} | Digital Output Supply Current | PD Pin = DGND, (Note 14) | <1 | | mA |
| | | PD Pin = V_{DR} | 0 | | |
| | Total Power Consumption | PD Pin = DGND, $C_L = 0\text{ pF}$ (Note 15) | 357 | 479 | mW (max) |
| | | PD Pin = V_{DR} | 50 | | |
| PSRR1 | Power Supply Rejection | Rejection of Full-Scale Error with $V_A = 3.0V$ vs. $3.6V$ | 58 | | dB |

AC Electrical Characteristics

Unless otherwise specified, the following specifications apply for AGND = DGND = DR GND = 0V, $V_A = V_D = +3.3V$, $V_{DR} = +2/.5V$, PD = 0V, $V_{REF} = +1.0V$, $V_{CM} = 1.0V$, $f_{CLK} = 66$ MHz, $t_r = t_f = 2$ ns, $C_L = 15$ pF/pin.

Boldface limits apply for $T_J = T_{MIN}$ to T_{MAX} : all other limits $T_J = 25^\circ C$ (Notes 7, 8, 9, 10, 12)

| Symbol | Parameter | Conditions | Typical (Note 10) | Limits (Note 10) | Units (Limits) |
|------------|---|--------------------------------|-------------------|------------------|------------------|
| | Maximum Clock Frequency | | 80 | 66 | MHz (min) |
| | Minimum Clock Frequency | | 1 | | MHz |
| | Clock Duty Cycle | | 40 60 | | %(min) %(max) |
| t_{CH} | Clock High Time | | 6.5 | | ns(min) |
| t_{CL} | Clock Low Time | | 6.5 | | ns(min) |
| t_{CONV} | Conversion Latency | | | 6 | Clock Cycles |
| t_{OD} | Data Output Delay after Rising CLK Edge | $V_{DR} = 2.5V$ | 7.5 | 11 | ns (max) |
| | | $V_{DR} = 3.3V$ | 6.7 | 10.5 | ns(max) |
| t_{AD} | Aperture Delay | | 2 | | ns |
| t_{AJ} | Aperture Jitter | | 1.2 | | ps rms |
| t_{DIS} | Data outputs into TRI-STATE Mode | | 10 | | ns |
| t_{EN} | Data Outputs Active after TRI-STATE | | 10 | | ns |
| t_{PD} | Power Down Mode Exit Cycle | 0.1 μF on pins 30, 31, 32 | 300 | | ns |

Note 1: Absolute Maximum Ratings indicate limits beyond which damage to the device may occur. Operating Ratings indicate conditions for which the device is functional, but do not guarantee specific performance limits. For guaranteed specifications and test conditions, see the Electrical Characteristics. The guaranteed specifications apply only for the test conditions listed. Some performance characteristics may degrade when the device is not operated under the listed test conditions.

Note 2: All voltages are measured with respect to GND = AGND = DGND = 0V, unless otherwise specified.

Note 3: When the input voltage at any pin exceeds the power supplies (that is, $V_{IN} < AGND$, or $V_{IN} > V_A$, V_D or V_{DR}), the current at that pin should be limited to 25 mA. The 50 mA maximum package input current rating limits the number of pins that can safely exceed the power supplies with an input current of 25 mA to two.

Note 4: The absolute maximum junction temperature (T_{Jmax}) for this device is $150^\circ C$. The maximum allowable power dissipation is dictated by T_{Jmax} , the junction-to-ambient thermal resistance (θ_{JA}), and the ambient temperature, (T_A), and can be calculated using the formula $P_{DMAX} = (T_{Jmax} - T_A) / \theta_{JA}$. In the 32-pin LQFP, θ_{JA} is $79^\circ C/W$, so $P_{DMAX} = 1,582$ mW at $25^\circ C$ and 823 mW at the maximum operating ambient temperature of $85^\circ C$. Note that the power consumption of this device under normal operation will typically be about 612 mW (357 typical power consumption + 255 mW output loading with 250 MHz input). The values for maximum power dissipation listed above will be reached only when the device is operated in a severe fault condition (e.g. when input or output pins are driven beyond the power supply voltages, or the power supply polarity is reversed). Obviously, such conditions should always be avoided.

Note 5: Human body model is 100 pF capacitor discharged through a 1.5 k Ω resistor. Machine model is 220 pF discharged through 0 Ω .

Note 6: The $235^\circ C$ reflow temperature refers to infrared reflow. For Vapor Phase Reflow (VPR), the following Conditions apply: Maintain the temperature at the top of the package body above $183^\circ C$ for a minimum 60 seconds. The temperature measured on the package body must not exceed $220^\circ C$. Only one excursion above $183^\circ C$ is allowed per reflow cycle.

Note 7: The inputs are protected as shown below. Input voltages above V_A or below GND will not damage this device, provided current is limited per (Note 3). However, errors in the A/D conversion can occur if the input goes above V_A or below GND by more than 100 mV. As an example, if V_A is 3.3V, the full-scale input voltage must be $\leq 3.4V$ to ensure accurate conversions.

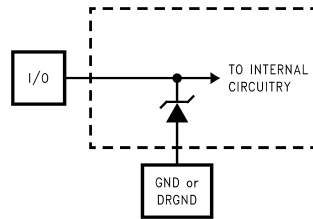

20050707

Note 8: To guarantee accuracy, it is required that $|V_A - V_D| \leq 100$ mV and separate bypass capacitors are used at each power supply pin.

Note 9: With the test condition for $V_{REF} = +1.0V$ (2 V_{P-P} differential input), the 11-bit LSB is 488 μV .

Note 10: Typical figures are at $T_A = T_J = 25^\circ C$, and represent most likely parametric norms. Test limits are guaranteed to National's AOQL (Average Outgoing Quality Level).

Note 11: Integral Non Linearity is defined as the deviation of the analog value, expressed in LSBs, from the straight line that passes through positive and negative full-scale.

Note 12: Timing specifications are tested at TTL logic levels, $V_{IL} = 0.4V$ for a falling edge and $V_{IH} = 2.4V$ for a rising edge.

Note 13: Optimum dynamic performance will be obtained by keeping the reference input in the 0.8V to 1.5V range. The LM4051CIM3-ADJ or the LM4051CIM3-1.2 bandgap voltage reference is recommended for this application.

AC Electrical Characteristics (Continued)

Note 14: I_{DR} is the current consumed by the switching of the output drivers and is primarily determined by load capacitance on the output pins, the supply voltage, V_{DR} , and the rate at which the outputs are switching (which is signal dependent). $I_{DR} = V_{DR}(C_0 \times f_0 + C_1 \times f_1 + \dots + C_{11} \times f_{11})$ where V_{DR} is the output driver power supply voltage, C_n is total capacitance on the output pin, and f_n is the average frequency at which that pin is toggling

Note 15: Power consumption excludes output driver power. See (Note 14).

Specification Definitions

APERTURE DELAY is the time after the rising edge of the clock to when the input signal is acquired or held for conversion.

APERTURE JITTER (APERTURE UNCERTAINTY) is the variation in aperture delay from sample to sample. Aperture jitter manifests itself as noise in the output.

COMMON MODE VOLTAGE (V_{CM}) is the d.c. potential present at both signal inputs to the ADC.

CONVERSION LATENCY See PIPELINE DELAY.

DIFFERENTIAL NON-LINEARITY (DNL) is the measure of the maximum deviation from the ideal step size of 1 LSB.

DUTY CYCLE is the ratio of the time that a repetitive digital waveform is high to the total time of one period. The specification here refers to the ADC clock input signal.

EFFECTIVE NUMBER OF BITS (ENOB, or EFFECTIVE BITS) is another method of specifying Signal-to-Noise and Distortion or SINAD. ENOB is defined as $(\text{SINAD} - 1.76) / 6.02$ and says that the converter is equivalent to a perfect ADC of this (ENOB) number of bits.

FULL POWER BANDWIDTH is a measure of the frequency at which the reconstructed output fundamental drops 3 dB below its low frequency value for a full scale input.

GAIN ERROR is the deviation from the ideal slope of the transfer function. It can be calculated as:

$$\text{Gain Error} = \text{Positive Full Scale Error} - \text{Offset Error}$$

INTEGRAL NON LINEARITY (INL) is a measure of the deviation of each individual code from a line drawn from negative full scale ($1/2$ LSB below the first code transition) through positive full scale ($1/2$ LSB above the last code transition). The deviation of any given code from this straight line is measured from the center of that code value.

INTERMODULATION DISTORTION (IMD) is the creation of additional spectral components as a result of two sinusoidal frequencies being applied to the ADC input at the same time. It is defined as the ratio of the power in the second and third order intermodulation products to the power in one of the original frequencies. IMD is usually expressed in dBFS.

MISSING CODES are those output codes that will never appear at the ADC outputs. The ADC11L066 is guaranteed not to have any missing codes.

NEGATIVE FULL SCALE ERROR is the difference between the input voltage ($V_{IN+} - V_{IN-}$) just causing a transition from negative full scale to the first code and its ideal value of 0.5 LSB.

OFFSET ERROR is the input voltage that will cause a transition from a code of 010 1111 1111 to a code of 100 0000 0000.

OUTPUT DELAY is the time delay after the rising edge of the clock before the data update is presented at the output pins.

PIPELINE DELAY (LATENCY) is the number of clock cycles between initiation of conversion and when that data is presented to the output driver stage. Data for any given sample is available at the output pins the Pipeline Delay plus the Output Delay after the sample is taken. New data is available at every clock cycle, but the data lags the conversion by the pipeline delay.

POSITIVE FULL SCALE ERROR is the difference between the actual last code transition and its ideal value of $1\frac{1}{2}$ LSB below positive full scale.

POWER SUPPLY REJECTION RATIO (PSRR) is a measure of how well the ADC rejects a change in the power supply voltage. For the ADC11L066, PSRR1 is the ratio of the change in Full-Scale Error that results from a change in the dc power supply voltage, expressed in dB. PSRR2 is a measure of how well an a.c. signal riding upon the power supply is rejected at the output.

SIGNAL TO NOISE RATIO (SNR) is the ratio, expressed in dB, of the rms value of the input signal to the rms value of the sum of all other spectral components below one-half the sampling frequency, not including harmonics or dc.

SIGNAL TO NOISE PLUS DISTORTION (S/N+D or SINAD) is the ratio, expressed in dB, of the rms value of the input signal to the rms value of all of the other spectral components below half the clock frequency, including harmonics but excluding dc.

SPURIOUS FREE DYNAMIC RANGE (SFDR) is the difference, expressed in dB, between the rms values of the input signal and the peak spurious signal, where a spurious signal is any signal present in the output spectrum that is not present at the input.

TOTAL HARMONIC DISTORTION (THD) is the ratio, expressed in dBc, of the rms total of the first nine harmonic levels at the output to the level of the fundamental at the output. THD is calculated as

$$\text{THD} = 20 \times \log \sqrt{\frac{f_2^2 + \dots + f_{10}^2}{f_1^2}}$$

where f_1 is the RMS power of the fundamental (output) frequency and f_2 through f_{10} are the RMS power in the first 9 harmonic frequencies.

SECOND HARMONIC DISTORTION (2ND HARM) is the difference expressed in dB, between the RMS power in the input frequency at the output and the power in its 2nd harmonic level at the output.

THIRD HARMONIC DISTORTION (3RD HARM) is the difference, expressed in dB, between the RMS power in the input frequency at the output and the power in its 3rd harmonic level at the output.

Timing Diagram

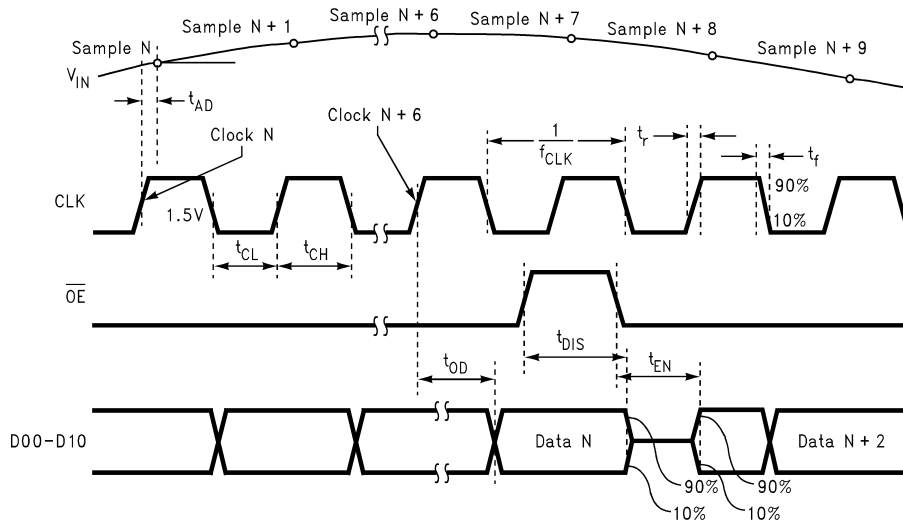

Output Timing

20050709

Transfer Characteristic

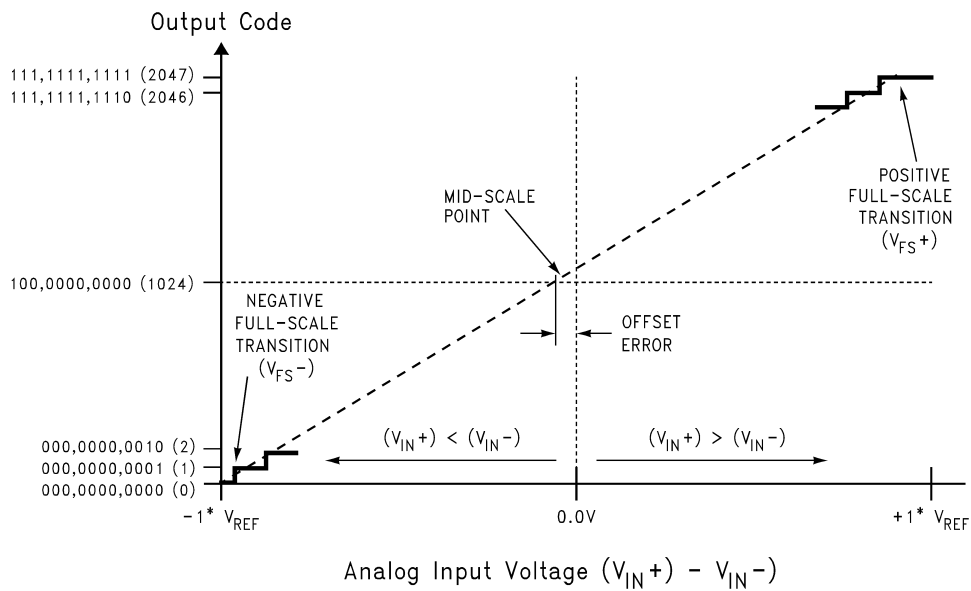
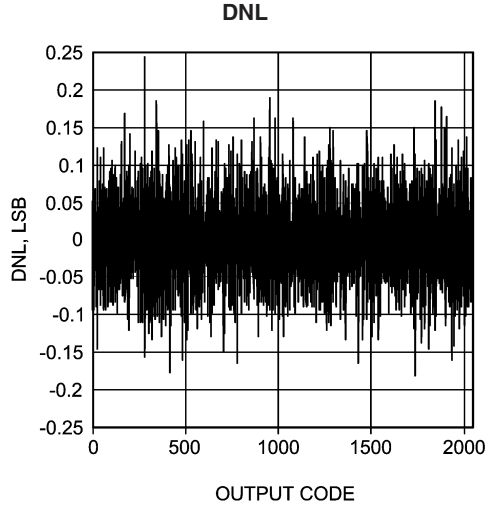

FIGURE 1. Transfer Characteristic

20050710

Typical Performance Characteristics $V_A = V_D = 3.3V$, $V_{DR} = 2.5V$, $f_{CLK} = 66\text{ MHz}$, $f_{IN} = 25\text{ MHz}$, $V_{REF} = 1.0V$, unless otherwise stated.



200507E6

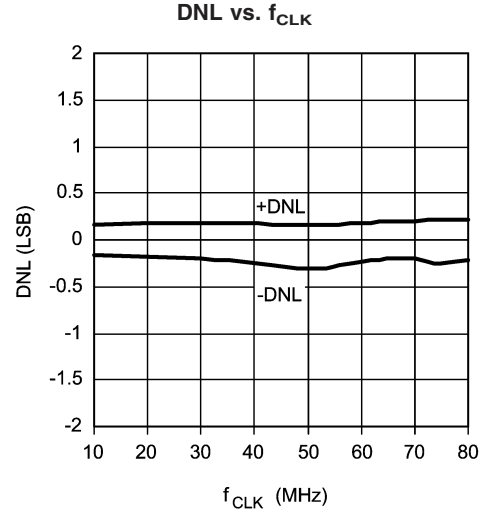

20050791

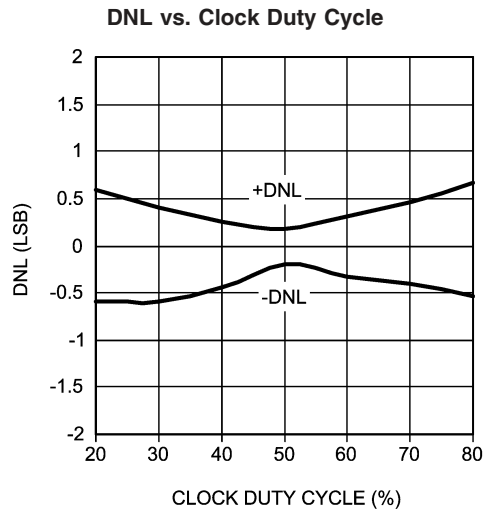

20050792

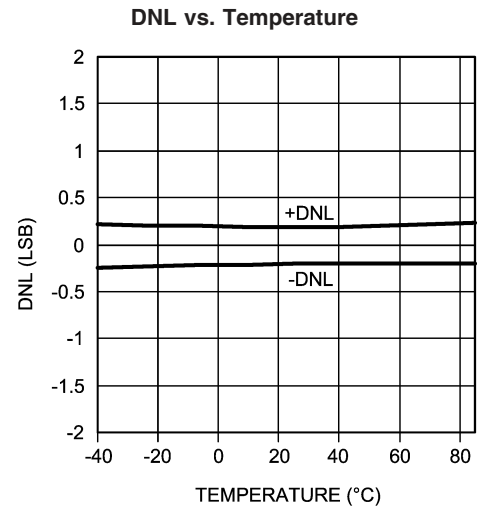

20050793

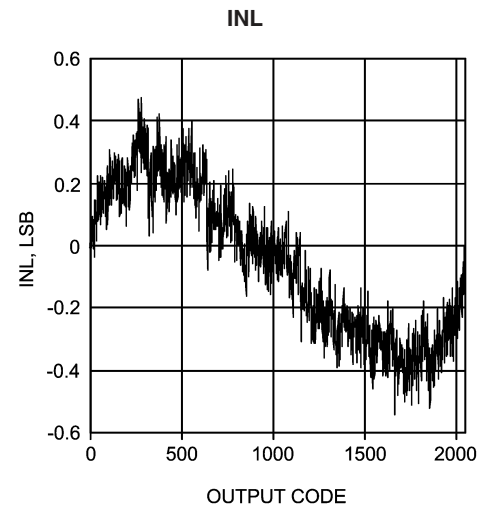

200507E7

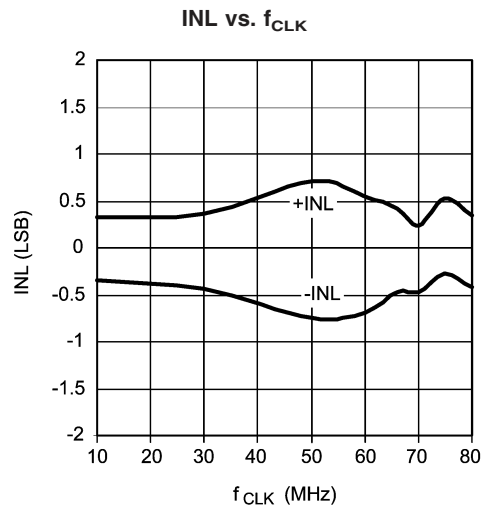

20050794

Typical Performance Characteristics $V_A = V_D = 3.3V$, $V_{DR} = 2.5V$, $f_{CLK} = 66\text{ MHz}$, $f_{IN} = 25\text{ MHz}$, $V_{REF} = 1.0V$, unless otherwise stated. (Continued)

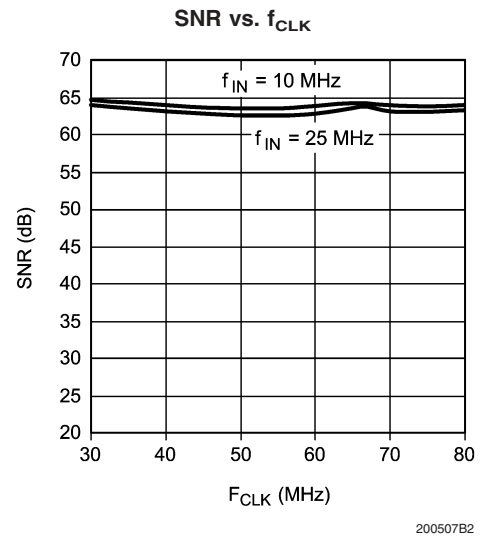
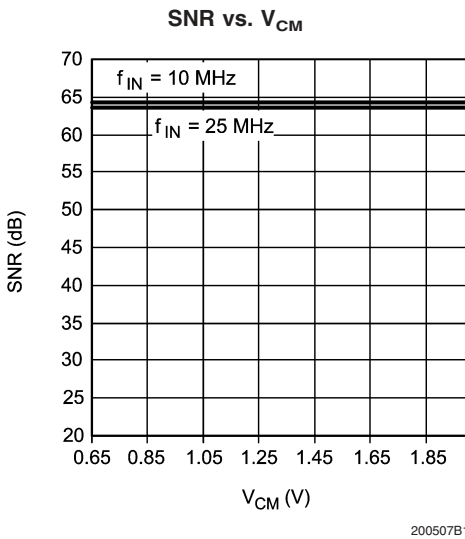
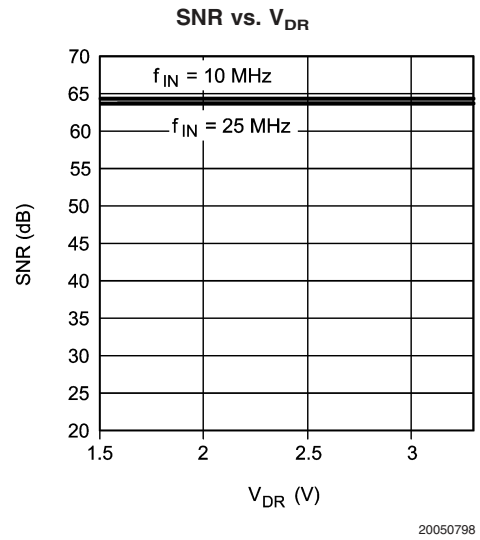
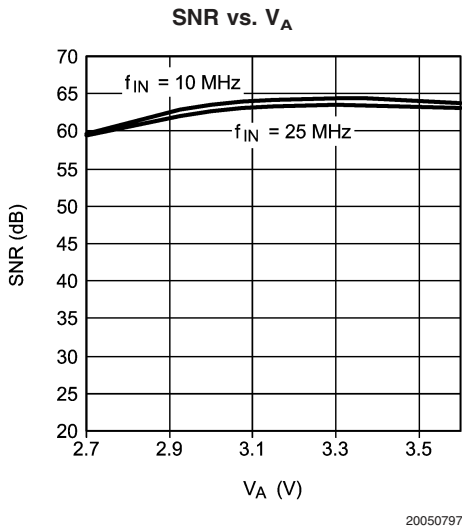
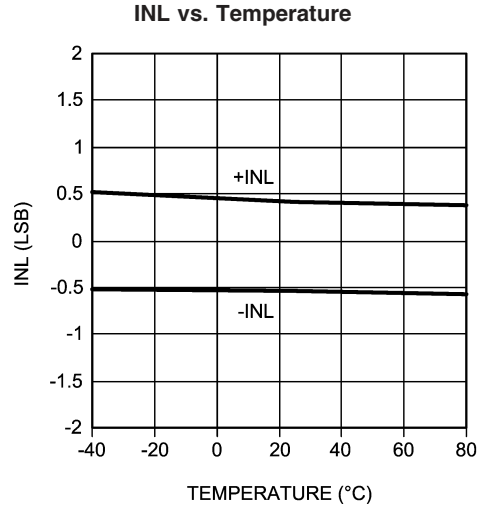
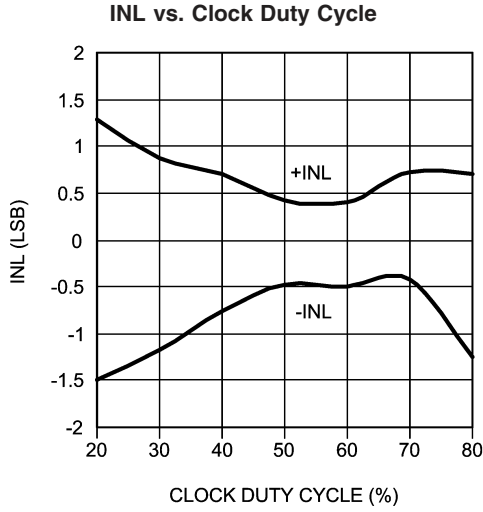

Typical Performance Characteristics $V_A = V_D = 3.3V$, $V_{DR} = 2.5V$, $f_{CLK} = 66\text{ MHz}$, $f_{IN} = 25\text{ MHz}$, $V_{REF} = 1.0V$, unless otherwise stated. (Continued)

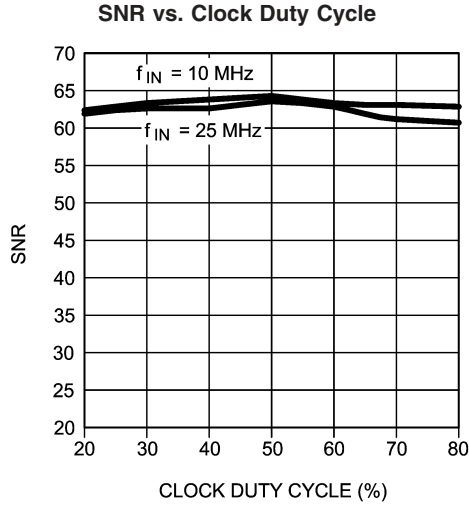

200507B3

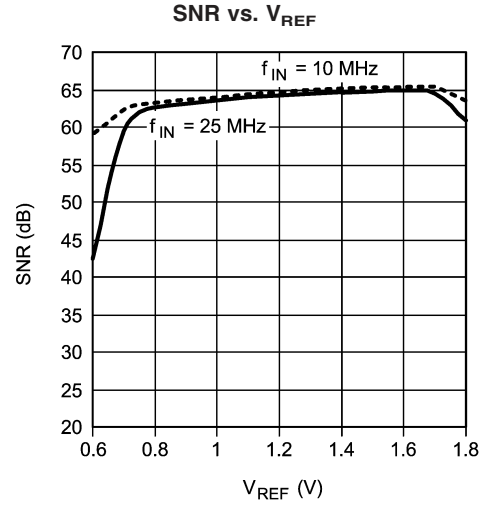

200507B4

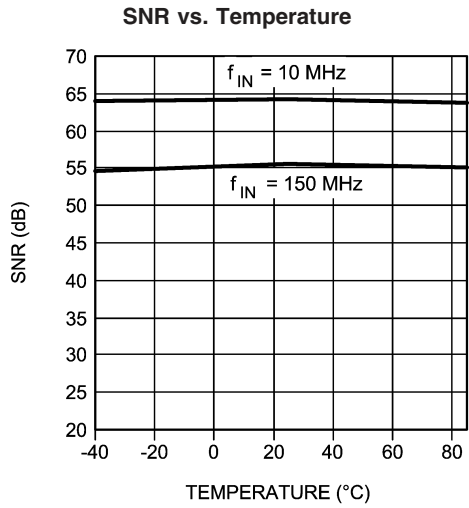

200507B5

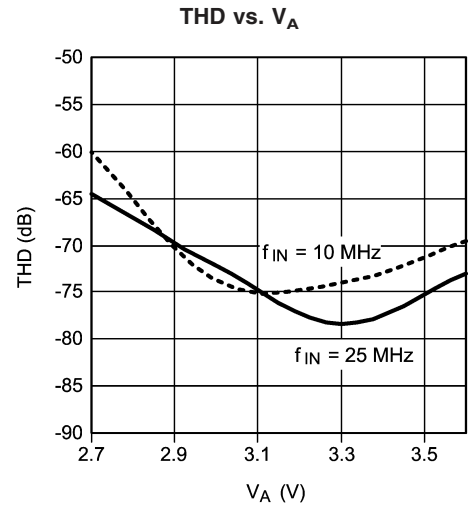

200507B6

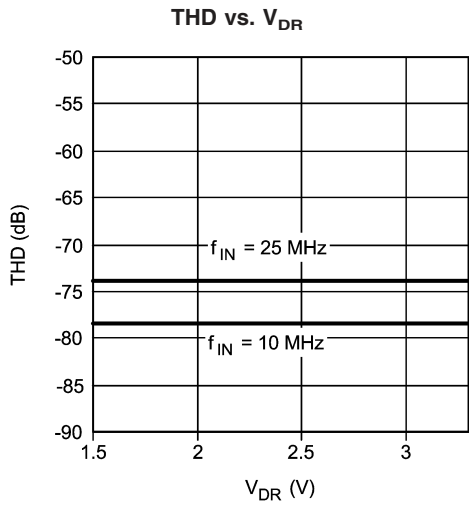

200507B7

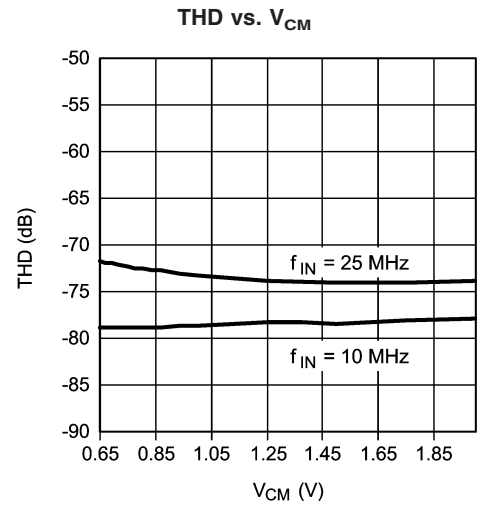

200507B8

Typical Performance Characteristics $V_A = V_D = 3.3V$, $V_{DR} = 2.5V$, $f_{CLK} = 66\text{ MHz}$, $f_{IN} = 25\text{ MHz}$, $V_{REF} = 1.0V$, unless otherwise stated. (Continued)

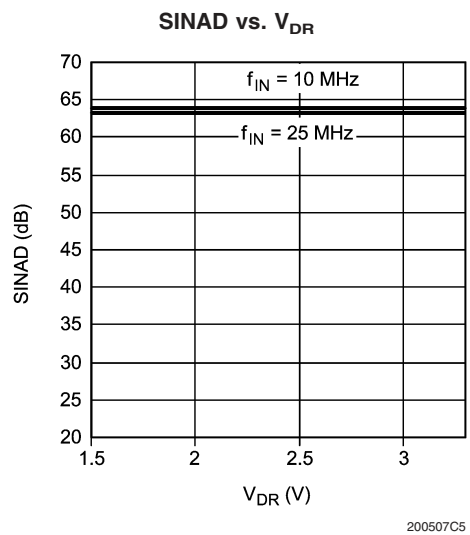
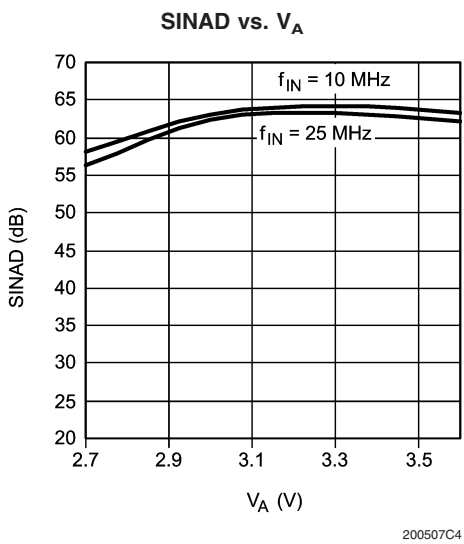
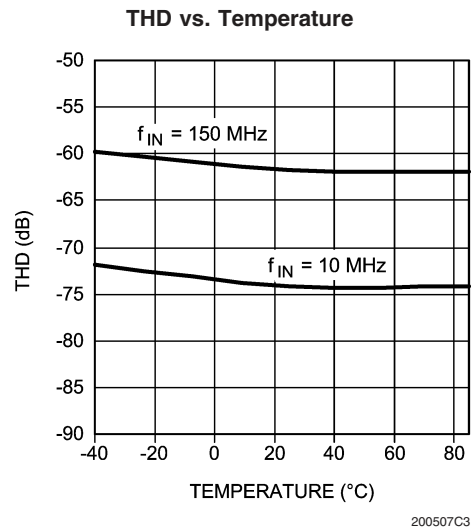
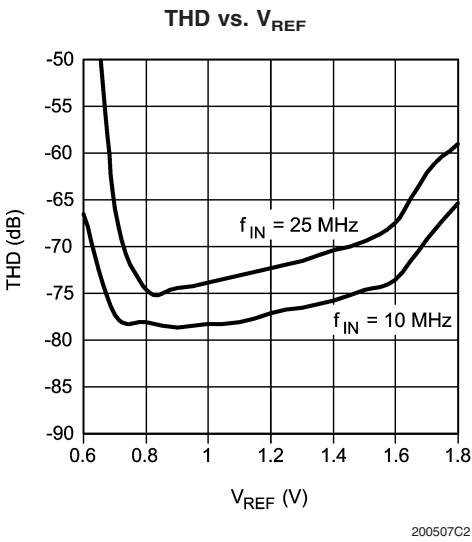
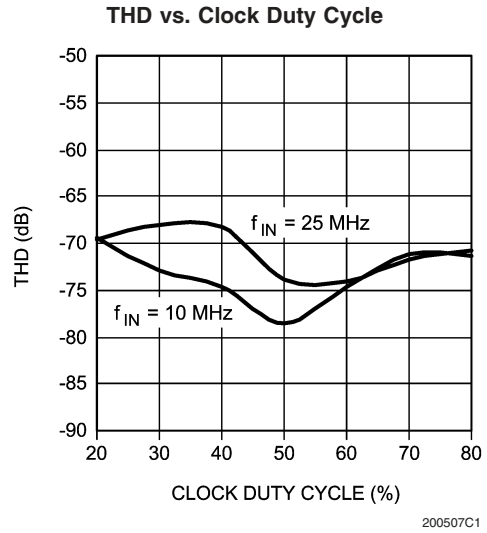
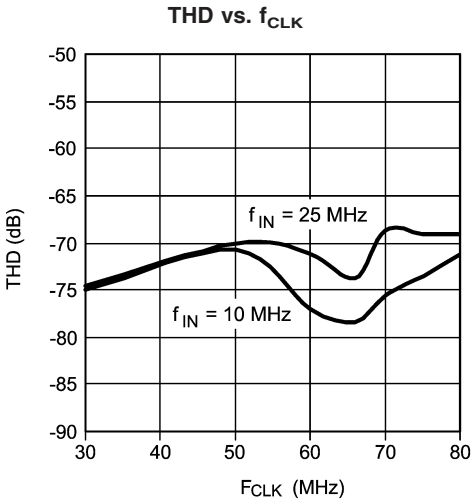

Typical Performance Characteristics $V_A = V_D = 3.3V$, $V_{DR} = 2.5V$, $f_{CLK} = 66\text{ MHz}$, $f_{IN} = 25\text{ MHz}$, $V_{REF} = 1.0V$, unless otherwise stated. (Continued)

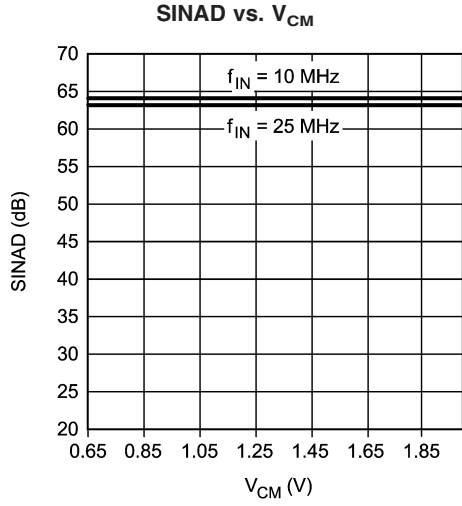

200507C6

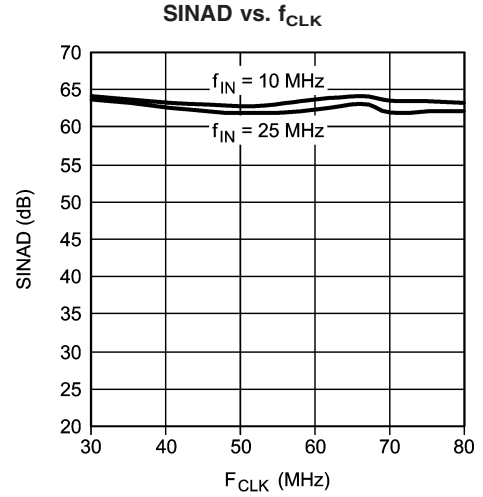

200507C7

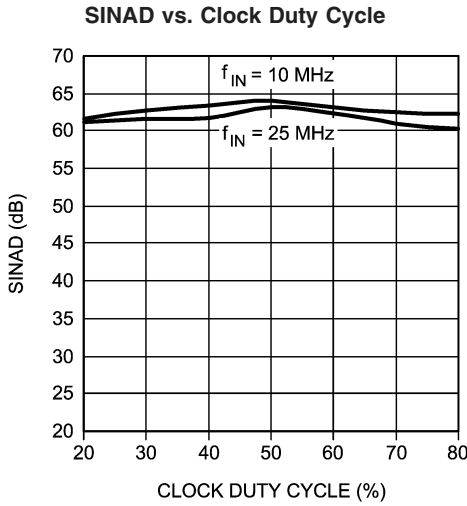

200507C8

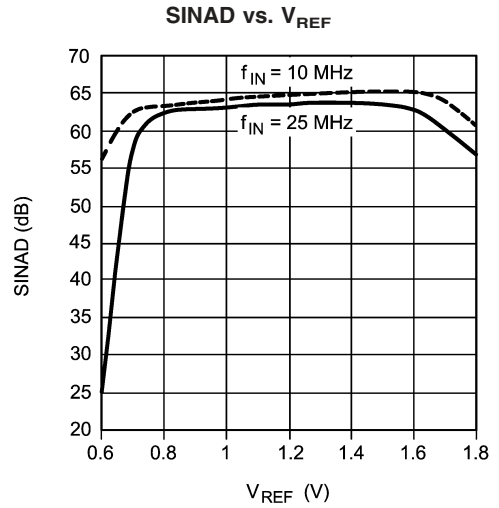

200507C9

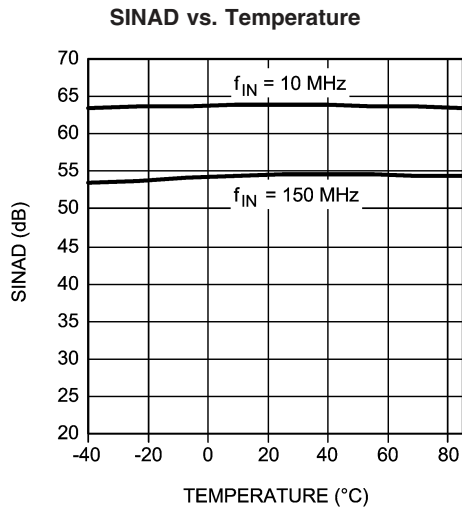

200507D1

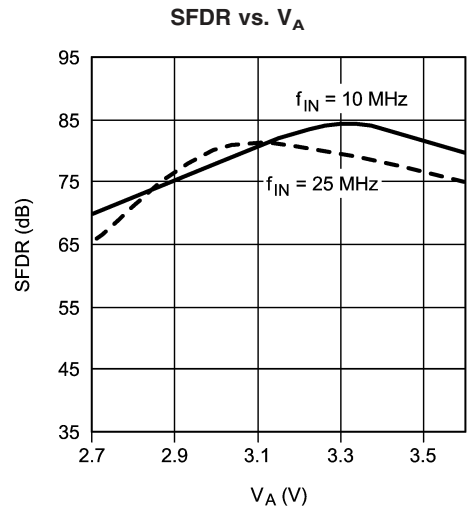

200507D2

Typical Performance Characteristics $V_A = V_D = 3.3V$, $V_{DR} = 2.5V$, $f_{CLK} = 66\text{ MHz}$, $f_{IN} = 25\text{ MHz}$, $V_{REF} = 1.0V$, unless otherwise stated. (Continued)

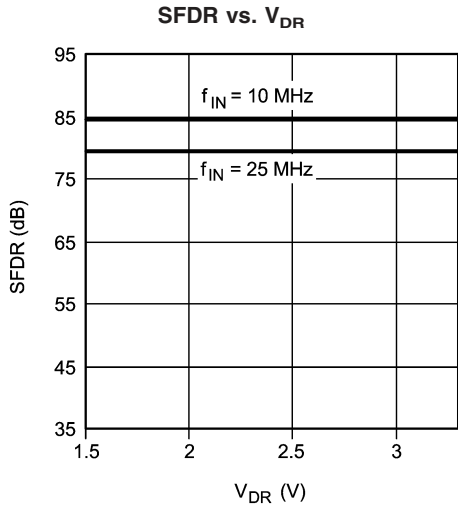

200507D3

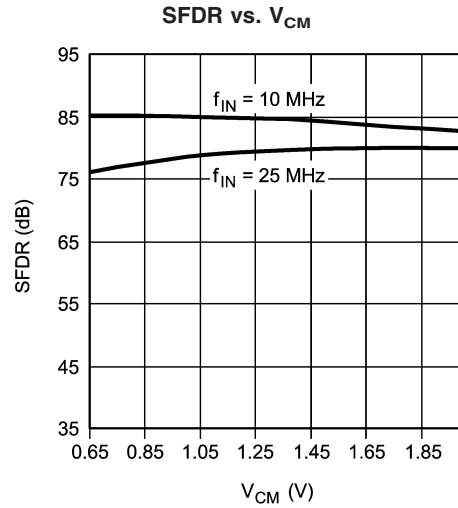

200507D4

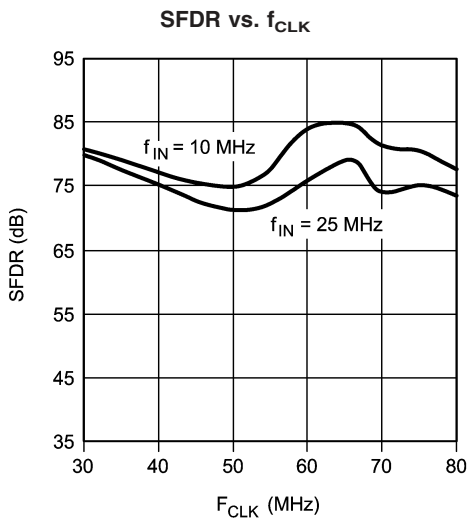

200507D5

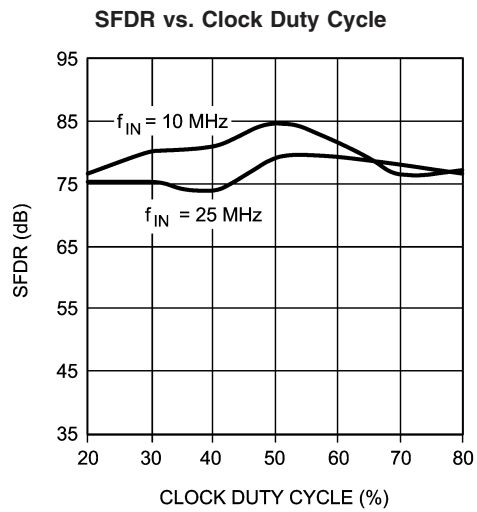

200507D6

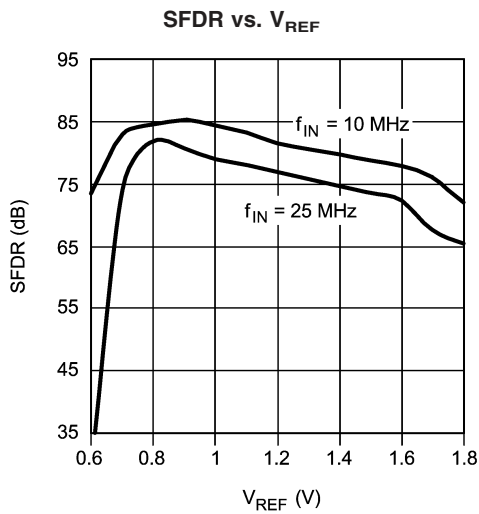

200507D7

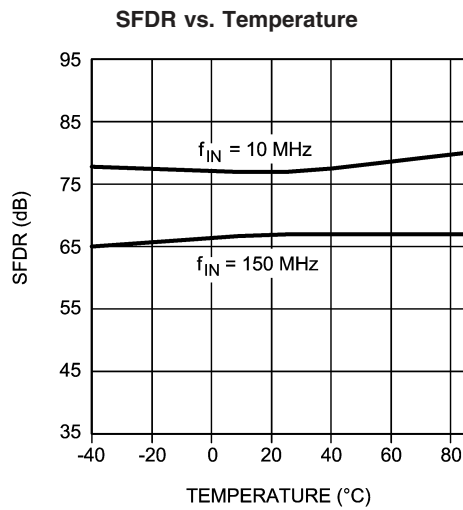

200507D8

Typical Performance Characteristics $V_A = V_D = 3.3V$, $V_{DR} = 2.5V$, $f_{CLK} = 66\text{ MHz}$, $f_{IN} = 25\text{ MHz}$, $V_{REF} = 1.0V$, unless otherwise stated. (Continued)

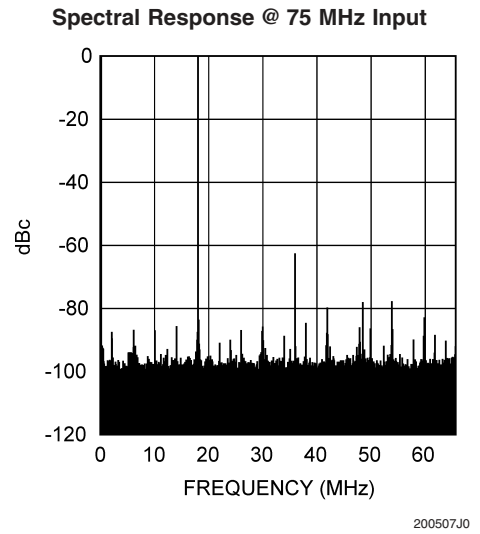
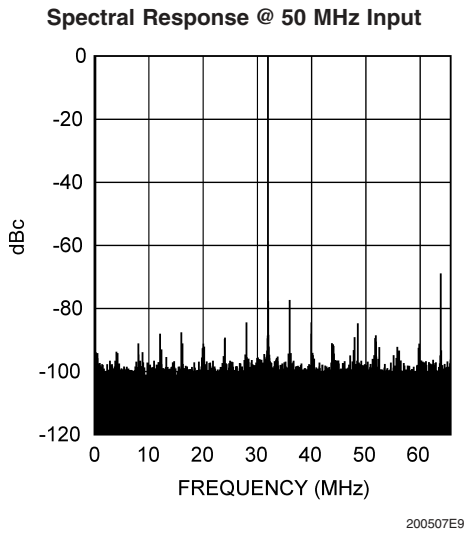
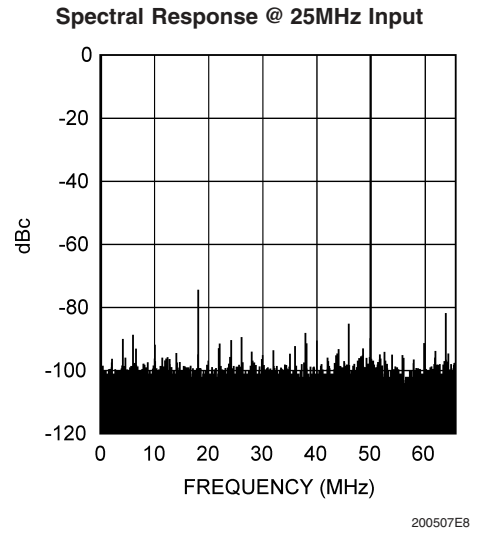
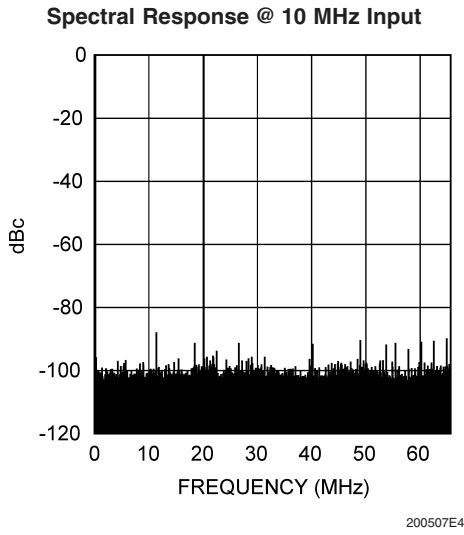
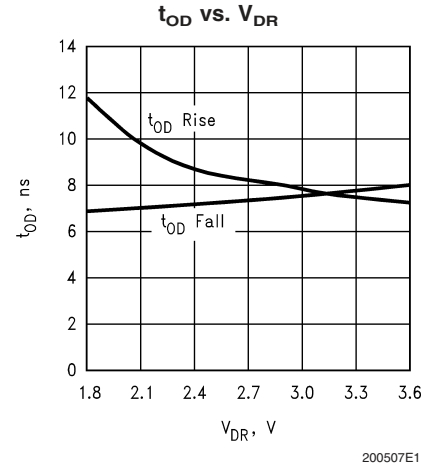
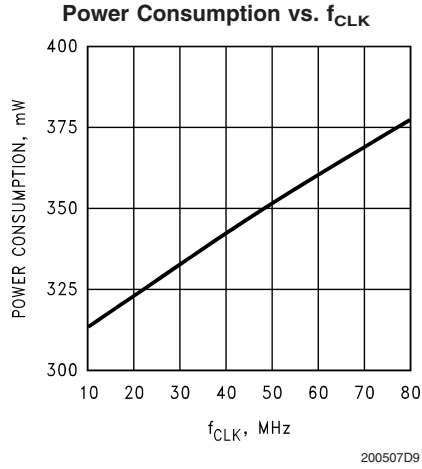

Typical Performance Characteristics $V_A = V_D = 3.3V$, $V_{DR} = 2.5V$, $f_{CLK} = 66\text{ MHz}$, $f_{IN} = 25\text{ MHz}$, $V_{REF} = 1.0V$, unless otherwise stated. (Continued)

Spectral Response @ 150 MHz Input

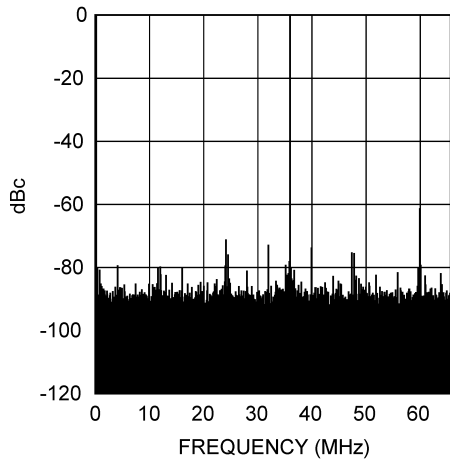

200507J2

Spectral Response @ 100 MHz Input

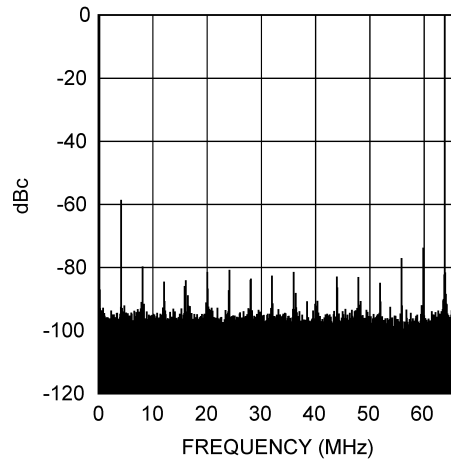

200507J1

Spectral Response @ 240 MHz Input

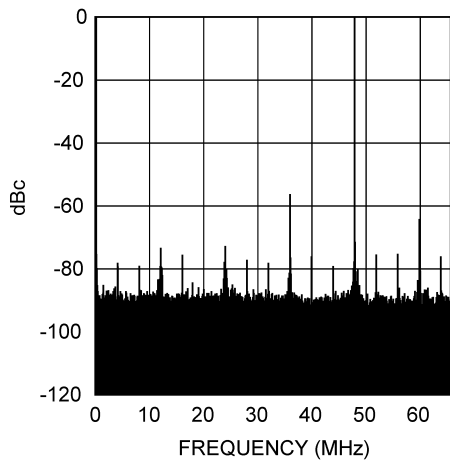

200507E5

Functional Description

Operating on a single +3.3V supply, the ADC11L066 uses a pipeline architecture and has error correction circuitry to help ensure maximum performance.

Differential analog input signals are digitized to 11 bits. Each analog input signal should have a peak-to-peak voltage equal to the input reference voltage, V_{REF} , be centered around a common mode voltage, V_{CM} and be 180° out of phase with each other. *Table 1. Input to Output Relationship–Differential Input* and *Table 2. Input to Output Relationship–Single-Ended Input* indicate the input to output relationship of the ADC11L066. Biasing one input to V_{CM} and driving the other input with its full range signal results in a 6 dB reduction of the output range, limiting it to the range of ¼ to ¾ of the minimum output range obtainable if both inputs were driven with complimentary signals. Section 1.3 explains how to avoid this signal reduction.

TABLE 1. Input to Output Relationship–Differential Input

| V_{IN+} | V_{IN-} | Output |
|---------------------------|---------------------------|---------------|
| $V_{CM} - 0.5 * V_{REF}$ | $V_{CM} + 0.5 * V_{REF}$ | 000 0000 0000 |
| $V_{CM} - 0.25 * V_{REF}$ | $V_{CM} + 0.25 * V_{REF}$ | 010 0000 0000 |
| V_{CM} | V_{CM} | 100 0000 0000 |
| $V_{CM} + 0.25 * V_{REF}$ | $V_{CM} - 0.25 * V_{REF}$ | 110 0000 0000 |
| $V_{CM} + 0.5 * V_{REF}$ | $V_{CM} - 0.5 * V_{REF}$ | 111 1111 1111 |

TABLE 2. Input to Output Relationship–Single-Ended Input

| V_{IN+} | V_{IN-} | Output |
|--------------------------|-----------|---------------|
| $V_{CM} - V_{REF}$ | V_{CM} | 000 0000 0000 |
| $V_{CM} - 0.5 * V_{REF}$ | V_{CM} | 010 0000 0000 |
| V_{CM} | V_{CM} | 100 0000 0000 |
| $V_{CM} + 0.5 * V_{REF}$ | V_{CM} | 110 0000 0000 |
| $V_{CM} + V_{REF}$ | V_{CM} | 111 1111 1111 |

The output word rate is the same as the clock frequency, which can be between 10 MSPS and 80 MSPS (typical). The analog input voltage is acquired at the rising edge of the clock and the digital data for that sample is delayed by the pipeline for 6 clock cycles.

A logic high on the power down (PD) pin reduces the converter power consumption to 50 mW.

Applications Information

1.0 OPERATING CONDITIONS

We recommend that the following conditions be observed for operation of the ADC11L066:

- $3.0 \text{ V} \leq V_A \leq 3.6 \text{ V}$
- $V_D = V_A$
- $1.8 \text{ V} \leq V_{DR} \leq V_D$
- $10 \text{ MHz} \leq f_{CLK} \leq 80 \text{ MHz}$
- $0.8 \text{ V} \leq V_{REF} \leq 1.5 \text{ V}$
- $0.5 \text{ V} \leq V_{CM} \leq 1.5 \text{ V}$

1.1 Analog Inputs

The ADC11L066 has two analog signal inputs, V_{IN+} and V_{IN-} . These two pins form a differential input pair. There is one reference input pin, V_{REF} .

1.2 Reference Pins

The ADC11L066 is designed to operate with a 1.0V reference, but performs well with reference voltages in the range of 0.8V to 1.5V. Lower reference voltages will decrease the signal-to-noise ratio (SNR) of the ADC11L066. Increasing the reference voltage (and the input signal swing) beyond 1.5V will degrade THD for a full-scale input. It is very important that all grounds associated with the reference voltage and the input signal make connection to the analog ground plane at a single point to minimize the effects of noise currents in the ground path.

The ADC11L066 will perform well with reference voltages up to 1.5V for full-scale input frequencies up to 10 MHz. However, more headroom is needed as the input frequency increases, so the maximum reference voltage (and input swing) will decrease for higher full-scale input frequencies.

The three Reference Bypass Pins (V_{RP} , V_{RM} and V_{RN}) are made available for bypass purposes only. These pins should each be bypassed to ground with a 0.1 μF capacitor. Smaller capacitor values will allow faster recovery from the power down mode, but may result in degraded noise performance. DO NOT LOAD these pins. Loading any of these pins may result in performance degradation.

The nominal voltages for the reference bypass pins are as follows:

$$V_{RM} = V_A / 2$$

$$V_{RP} = V_{RM} + V_{REF} / 2$$

$$V_{RN} = V_{RM} - V_{REF} / 2$$

The V_{RM} pin may be used as a common mode voltage source (V_{CM}) for the analog input pins as long as no d.c. current is drawn from it. However, because the voltage at this pin is half that of the V_A supply pin, using these pins for a common mode source will result in reduced input headroom (the difference between the V_A supply voltage and the peak signal voltage at either analog input) and the possibility of reduced THD and SFDR performance. For this reason, it is recommended that V_A always exceed V_{REF} by at least 2 Volts. For high input frequencies it may be necessary to increase this headroom to maintain THD and SFDR performance. Alternatively, use V_{RN} for a V_{CM} source.

1.3 Signal Inputs

The signal inputs are V_{IN+} and V_{IN-} . The input signal, V_{IN} , is defined as

$$V_{IN} = (V_{IN+}) - (V_{IN-})$$

Figure 2 shows the expected input signal range.

Note that the nominal input common mode voltage is V_{REF} and the nominal input signals each run between the limits of $V_{REF}/2$ and $3V_{REF}/2$. The Peaks of the input signals should never exceed the voltage described as

$$\text{Peak Input Voltage} = V_A - 0.8$$

to maintain dynamic performance.

The ADC11L066 performs best with a differential input with each input centered around a common mode voltage, V_{CM} (minimum of 0.5V). The peak-to-peak voltage swing at both V_{IN+} and V_{IN-} should not exceed the value of the reference voltage or the output data will be clipped.

Applications Information (Continued)

The two input signals should be exactly 180° out of phase from each other and of the same amplitude. For single frequency (sine wave) inputs, angular errors result in a reduction of the effective full scale input. For a complex waveform, however, angular errors will result in distortion.

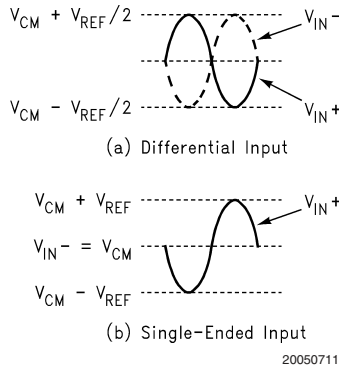

FIGURE 2. Expected Input Signal Range

For angular deviations of up to 10 degrees from these two signals being 180 out of phase with each other, the full scale error in LSB can be described as approximately

$$E_{FS} = \text{dev}^{1.79}$$

Where dev is the angular difference between the two signals having a 180° relative phase relationship to each other (see Figure 2). Drive the analog inputs with a source impedance less than 100Ω.

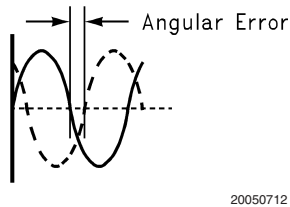

FIGURE 3. Angular Errors Between the Two Input Signals Will Reduce the Output Level or Cause Distortion

For differential operation, each analog input pin of the differential pair should have a peak-to-peak voltage equal to the input reference voltage, V_{REF} , and be centered around V_{CM} .

1.3.1 Single-Ended Operation

Single-ended performance is lower than with differential input signals, so single-ended operation is not recommended. However, if single-ended operation is required, one of the analog inputs should be connected to the d.c. common mode voltage of the driven input. The peak-to-peak differential input signal should be twice the reference voltage to maximize SNR and SINAD performance (Figure 2b).

For example, set V_{REF} to 0.5V, bias V_{IN-} to 1.0V and drive V_{IN+} with a signal range of 0.5V to 1.5V.

Because very large input signal swings can degrade distortion performance, better performance with a single-ended input can be obtained by reducing the reference voltage while maintaining a full-range output. Table 1. Input to Output

Relationship—Differential Input and Table 2. Input to Output Relationship—Single-Ended Input indicate the input to output relationship of the ADC11L066.

1.3.2 Driving the Analog Inputs

The V_{IN+} and the V_{IN-} inputs of the ADC11L066 consist of an analog switch followed by a switched-capacitor amplifier. The capacitance seen at the analog input pins changes with the clock level, appearing as 8 pF when the clock is low, and 7 pF when the clock is high.

As the internal sampling switch opens and closes, current pulses occur at the analog input pins, resulting in voltage spikes at the signal input pins. As a driving amplifier attempts to counteract these voltage spikes, a damped oscillation may appear at the ADC analog input. To help isolate the pulses at the ADC input from the amplifier output, use RCs at the inputs, as can be seen in Figure 4 and Figure 5. These components should be placed close to the ADC inputs because the input pins of the ADC is the most sensitive part of the system and this is the last opportunity to filter that input.

Any amplifier driving the ADC11L066 input pins must be able to react to the voltage spikes at the input and settle before the sampling switch opens. The LMH6702 LMH6628, LMH6622 and the LMH6655 are good amplifiers for driving the ADC11L066.

For Nyquist applications the RC pole should be at the ADC sample rate. The ADC input capacitance in the sample mode should be considered when setting the RC pole. Setting the pole in this manner will provide best SINAD performance.

To obtain best SNR performance, leave the RC values as calculated. To obtain best SINAD and ENOB performance, reduce the RC time constant until SNR and THD are numerically equal to each other. To obtain best distortion and SFDR performance, eliminate the RC altogether.

For undersampling applications, the RC pole should be set at about 1.5 to 2 times the maximum input frequency to maintain a linear delay response.

A single-ended to differential conversion circuit is shown in Figure 5. Table 3 gives resistor values for that circuit to provide input signals in a range of 1.0V ±0.5V at each of the differential input pins of the ADC11L066.

TABLE 3. Resistor values for Circuit of Figure 5

| SIGNAL RANGE | R1 | R2 | R3 | R4 | R5, R6 |
|--------------|------|------|------|-------|--------|
| 0 - 0.25V | open | 0Ω | 124Ω | 1500Ω | 1000Ω |
| 0 - 0.5V | 0Ω | open | 499Ω | 1500Ω | 499Ω |
| ±0.5V | 100Ω | 698Ω | 100Ω | 698Ω | 499Ω |

1.3.3 Input Common Mode Voltage

The input common mode voltage, V_{CM} , should be in the range of 0.5V to 1.5V and be of a value such that the peak excursions of the analog signal does not go more negative than ground or more positive than 0.8 Volts below the V_A supply voltage. The nominal V_{CM} should generally be about 1.0V, but V_{RM} or V_{RN} can be used as a V_{CM} source as long as no d.c. current is drawn from either of these pins.

2.0 DIGITAL INPUTS

Digital inputs are TTL/CMOS compatible and consist of CLK, OE and PD.

Applications Information (Continued)

2.1 CLK

The **CLK** signal controls the timing of the sampling process. Drive the clock input with a stable, low jitter clock signal in the range of 10 MHz to 80 MHz with rise and fall times of less than 2 ns. The trace carrying the clock signal should be as short as possible and should not cross any other signal line, analog or digital, not even at 90°.

The **CLK** signal also drives an internal state machine. If the **CLK** is interrupted, or its frequency is too low, the charge on internal capacitors can dissipate to the point where the accuracy of the output data will degrade. This is what limits the lowest sample rate to 1 MSPS.

The duty cycle of the clock signal can affect the performance of any A/D Converter. Because achieving a precise duty cycle is difficult, the ADC11L066 is designed to maintain performance over a range of duty cycles. While it is specified and performance is guaranteed with a 50% clock duty cycle, performance is typically maintained over a clock duty cycle range of 40% to 60%.

The clock line should be series terminated at the clock source in the characteristic impedance of that line if the clock line is longer than

$$\frac{t_r}{6 \times t_{prop}}$$

where t_r is the clock rise time and t_{prop} is the propagation rate of the signal along the trace. For a typical board of FR-4 material, t_{PROP} is about 150 ps/in, or 60 ps/cm.

The **CLOCK** pin may need to be a.c. terminated with a series RC such that the resistor value is equal to the characteristic impedance of the clock line and the capacitor value is

$$C \geq \frac{1.2 \times 10^{-9} \times l}{Z_o}$$

where "l" is the line length in inches and Z_o is the characteristic impedance of the clock line. This termination should be located as close as possible to, but within one centimeter of, the ADC11L066 clock pin as shown in *Figure 4*. It should also be located beyond the ADC clock pin as seen from the clock source.

Take care to maintain a constant clock line impedance throughout the length of the line and to properly terminate the source end of the line with its characteristic impedance. Refer to Application Note AN-905 for information on setting characteristic impedance.

2.2 \overline{OE}

The \overline{OE} pin, when high, puts the output pins into a high impedance state. When this pin is low the outputs are in the active state. The ADC11L066 will continue to convert whether this pin is high or low, but the output can not be read while the \overline{OE} pin is high.

Since ADC noise increases with increased output capacitance at the digital output pins, do use the TRI-STATE outputs of the ADC11L066 to drive a bus. Rather, each output pin should be located close to and drive a single digital input pin. To further reduce ADC noise, a 100 Ω resistor in series with each ADC digital output pin, located close to their respective pins, should be added to the circuit. See Section 3.0.

2.3 PD

The PD pin, when high, holds the ADC11L066 in a power-down mode to conserve power when the converter is not being used. The power consumption in this state is 50 mW with a 66 MHz clock and 30 mW if the clock is stopped. The output data pins are undefined in this mode. The data in the pipeline is corrupted while in the power down mode.

The Power Down Mode Exit Cycle time is determined by the value of the capacitors on pins 30, 31 and 32 and is about 300 ns with the recommended 0.1 μ F on these pins. These capacitors lose their charge in the Power Down mode and must be recharged by on-chip circuitry before conversions can be accurate. Smaller capacitor values allow faster recovery from the power down mode, but can result in a reduction in SNR, SINAD and ENOB performance.

3.0 OUTPUTS

The ADC11L066 has 11 TTL/CMOS compatible Data Output pins. The offset binary data is present at these outputs while the \overline{OE} and PD pins are low. While the t_{OD} time provides information about output timing, a simple way to capture a valid output is to latch the data on the *rising edge* of the conversion clock (pin 10).

Be very careful when driving a high capacitance bus. The more capacitance the output drivers must charge for each conversion, the more instantaneous digital current flows through V_{DR} and DR GND. These large charging current spikes can cause on-chip ground noise and couple into the analog circuitry, degrading dynamic performance. Adequate bypassing, limiting output capacitance and careful attention to the ground plane will reduce this problem. Additionally, bus capacitance beyond the specified 15 pF/pin will cause t_{OD} to increase, making it difficult to properly latch the ADC output data. The result could be an apparent reduction in dynamic performance.

To minimize noise due to output switching, minimize the load currents at the digital outputs. This can be done by connecting buffers between the ADC outputs and any other circuitry (74ACQ541, for example). Only one driven input should be connected to each output pin. Additionally, inserting series resistors of 100 Ω at the digital outputs, close to the ADC pins, will isolate the outputs from trace and other circuit capacitances and limit the output currents, which could otherwise result in performance degradation. See *Figure 4*.

While the ADC11L066 will operate with V_{DR} voltages down to 1.8V, t_{OD} increases with reduced V_{DR} . Be careful of external timing when using reduced V_{DR} .

Applications Information (Continued)

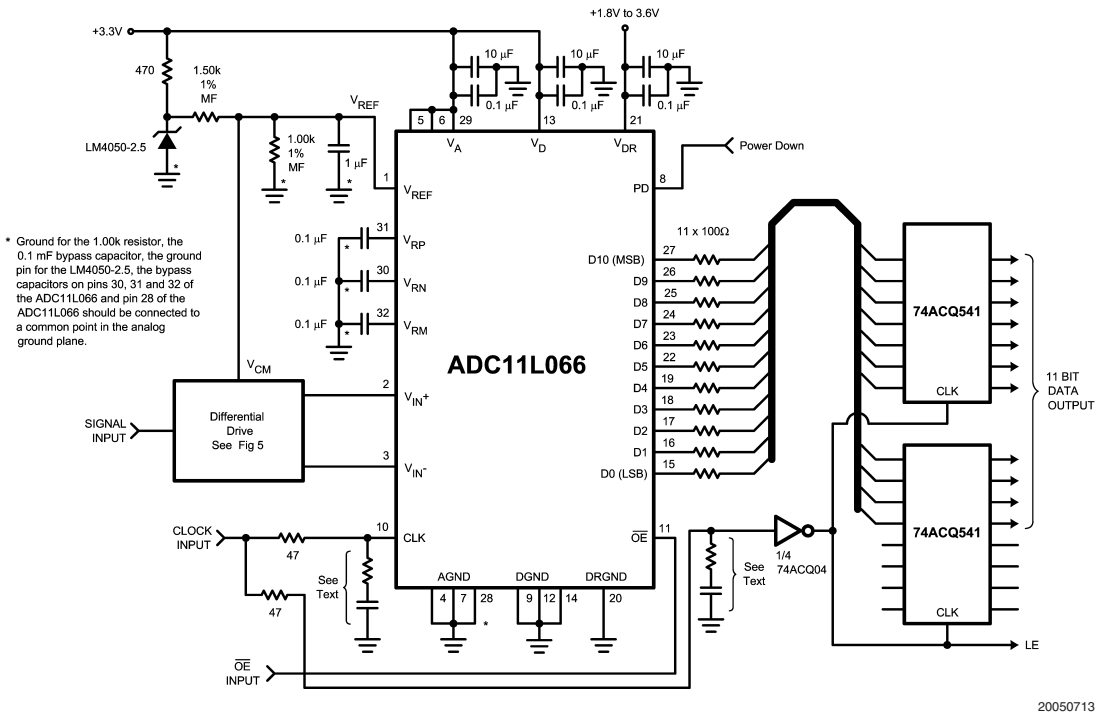

FIGURE 4. Simple Application Circuit with Single-Ended to Differential Buffer

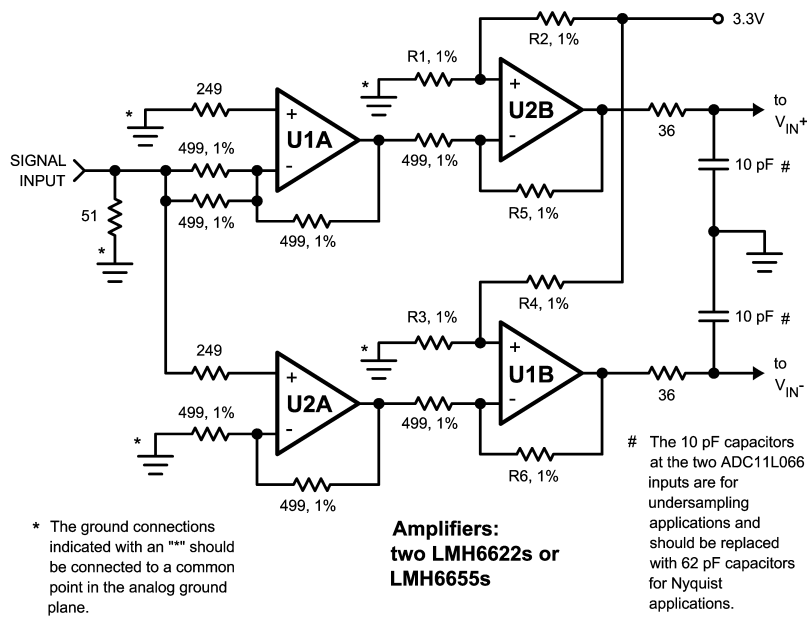

FIGURE 5. Differential Drive Circuit of Figure 4

Applications Information (Continued)

weight will have little effect upon the logic-generated noise.

This is because of the skin effect. Total surface area is more important than is total ground plane volume.

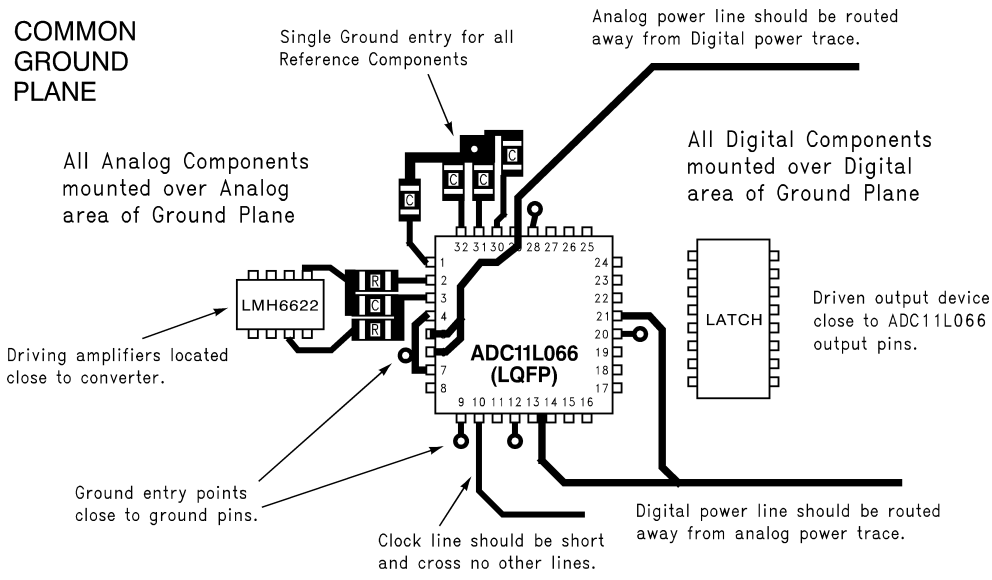

FIGURE 7. Example of a Suitable Layout

Generally, analog and digital lines should cross each other at 90° to avoid crosstalk. To maximize accuracy in high speed, high resolution systems, however, avoid crossing analog and digital lines altogether. It is important to keep clock lines as short as possible and isolated from ALL other lines, including other digital lines. Even the generally accepted 90° crossing should be avoided with the clock line as even a little coupling can cause problems at high frequencies. This is because other lines can introduce jitter into the clock line, which can lead to degradation of SNR. Also, the high speed clock can introduce noise into the analog chain.

Best performance at high frequencies and at high resolution is obtained with a straight signal path. That is, the signal path through all components should form a straight line wherever possible.

Be especially careful with the layout of inductors. Mutual inductance can change the characteristics of the circuit in which they are used. Inductors should *not* be placed side by side, even with just a small part of their bodies beside each other.

The analog input should be isolated from noisy signal traces to avoid coupling of spurious signals into the input. Any external component (e.g., a filter capacitor) connected between the converter's input pins and ground or to the reference input pin and ground should be connected to a very clean point in the ground plane.

Figure 7 gives an example of a suitable layout. All analog circuitry (input amplifiers, filters, reference components, etc.) should be placed in the analog area of the board. All digital circuitry and I/O lines should be placed in the digital area of the board. Furthermore, all components in the reference circuitry and the input signal chain that are connected to ground should be connected together with short traces and enter the ground plane at a single point. All ground connections should have a low inductance path to ground.

6.0 DYNAMIC PERFORMANCE

To achieve the best dynamic performance, the clock source driving the CLK input must be free of jitter. Isolate the ADC clock from any digital circuitry with buffers, as with the clock tree shown in Figure 8.

As mentioned in Section 5.0, it is good practice to keep the ADC clock line as short as possible and to keep it well away from any other signals. Other signals can introduce jitter into the clock signal, which can lead to reduced SNR performance, and the clock can introduce noise into other lines. Even lines with 90° crossings have capacitive coupling, so try to avoid even these 90° crossings of the clock line.

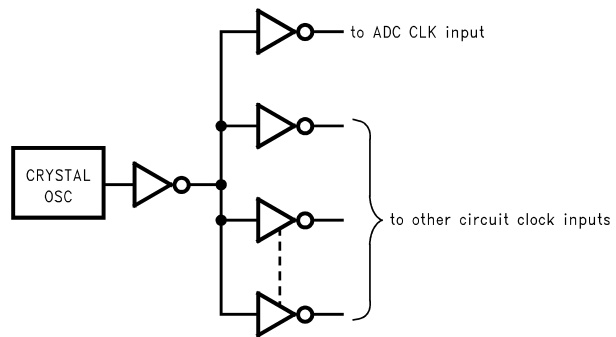

FIGURE 8. Isolating the ADC Clock from other Circuitry with a Clock Tree

7.0 COMMON APPLICATION PITFALLS

Driving the inputs (analog or digital) beyond the power supply rails. For proper operation, all inputs should not go more than 100 mV beyond the supply rails (more than 100 mV below the ground pins or 100 mV above the supply

Applications Information (Continued)

pins). Exceeding these limits on even a transient basis may cause faulty or erratic operation. It is not uncommon for high speed digital components (e.g., 74F and 74AC devices) to exhibit overshoot or undershoot that goes above the power supply or below ground. A resistor of about 50Ω to 100Ω in series with any offending digital input, close to the signal source, will eliminate the problem.

Do not allow input voltages to exceed the supply voltage, even on a transient basis. Not even during power up or power down.

Be careful not to overdrive the inputs of the ADC11L066 with a device that is powered from supplies outside the range of the ADC11L066 supply. Such practice may lead to conversion inaccuracies and even to device damage.

Attempting to drive a high capacitance digital data bus.

The more capacitance the output drivers must charge for each conversion, the more instantaneous digital current flows through V_{DR} and DR GND. These large charging current spikes can couple into the analog circuitry, degrading dynamic performance. Adequate bypassing and maintaining separate analog and digital areas on the pc board will reduce this problem.

Additionally, bus capacitance beyond the specified 15 pF/pin will cause t_{OD} to increase, making it difficult to properly latch the ADC output data. The result could, again, be a reduction in dynamic performance.

The digital data outputs should be buffered (with 74ACQ541, for example). Dynamic performance can also be improved by adding series resistors at each digital output, close to the ADC11L066, which reduces the energy coupled back into the converter output pins by limiting the output current. A reasonable value for these resistors is 100Ω.

Using an inadequate amplifier to drive the analog input.

As explained in Section 1.3, the capacitance seen at the input alternates between 8 pF and 7 pF, depending upon the phase of the clock. This dynamic load is more difficult to drive than is a fixed capacitance.

If the amplifier exhibits overshoot, ringing, or any evidence of instability, even at a very low level, it will degrade performance. A small series resistor at each amplifier output and a capacitor across the analog inputs (as shown in *Figures 5, 6*) will improve performance. The LMH6702, LMH6628, LMH6622 and LMH6655 have been successfully used to drive the analog inputs of the ADC11L066.

Also, it is important that the signals at the two inputs have exactly the same amplitude and be exactly 180° out of phase with each other. Board layout, especially equality of the length of the two traces to the input pins, will affect the effective phase between these two signals. Remember that an operational amplifier operated in the non-inverting configuration will exhibit more time delay than will the same device operating in the inverting configuration.

Operating with the reference pins outside of the specified range. As mentioned in Section 1.2, V_{REF} should be in the range of

$$0.8V \leq V_{REF} \leq 1.5V$$

Operating outside of these limits could lead to performance degradation.

Using a clock source with excessive jitter, using excessively long clock signal trace, or having other signals coupled to the clock signal trace. This will cause the sampling interval to vary, causing excessive output noise and a reduction in SNR and SINAD performance.

Physical Dimensions inches (millimeters) unless otherwise noted

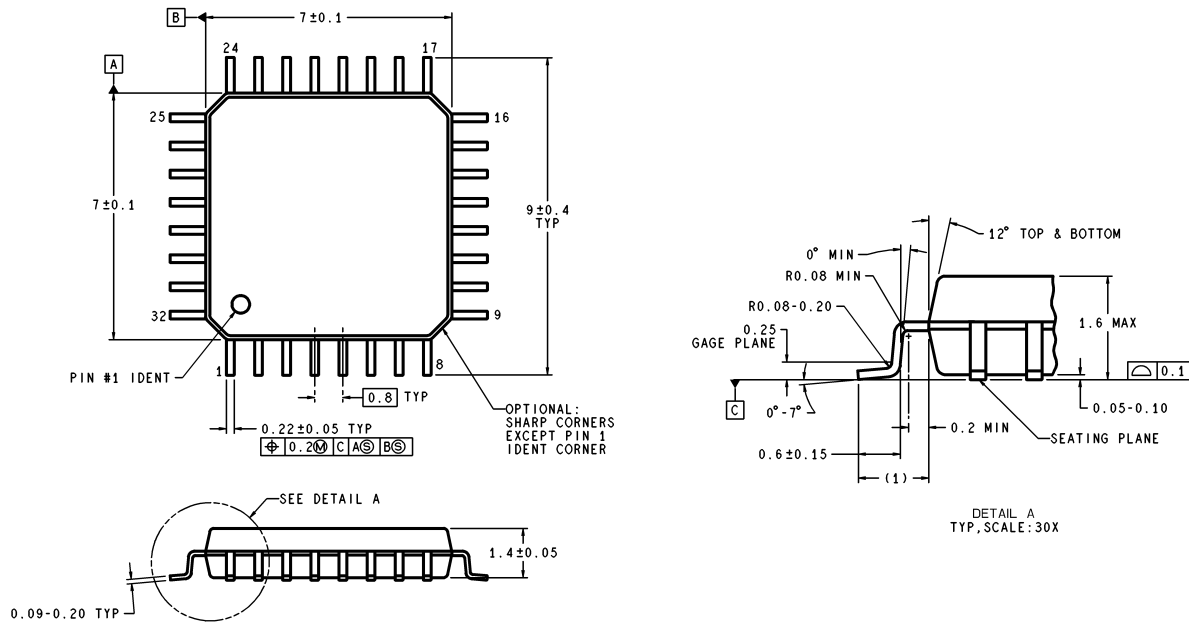

DIMENSIONS ARE IN MILLIMETERS

VBE32A (Rev E)

32-Lead LQFP Package
Ordering Number ADC11L066CIVY
NS Package Number VBE32A

LIFE SUPPORT POLICY

NATIONAL'S PRODUCTS ARE NOT AUTHORIZED FOR USE AS CRITICAL COMPONENTS IN LIFE SUPPORT DEVICES OR SYSTEMS WITHOUT THE EXPRESS WRITTEN APPROVAL OF THE PRESIDENT AND GENERAL COUNSEL OF NATIONAL SEMICONDUCTOR CORPORATION. As used herein:

1. Life support devices or systems are devices or systems which, (a) are intended for surgical implant into the body, or (b) support or sustain life, and whose failure to perform when properly used in accordance with instructions for use provided in the labeling, can be reasonably expected to result in a significant injury to the user.
2. A critical component is any component of a life support device or system whose failure to perform can be reasonably expected to cause the failure of the life support device or system, or to affect its safety or effectiveness.

BANNED SUBSTANCE COMPLIANCE

National Semiconductor certifies that the products and packing materials meet the provisions of the Customer Products Stewardship Specification (CSP-9-111C2) and the Banned Substances and Materials of Interest Specification (CSP-9-111S2) and contain no "Banned Substances" as defined in CSP-9-111S2.



National Semiconductor
Americas Customer Support Center
 Email: new.feedback@nsc.com
 Tel: 1-800-272-9959

National Semiconductor
Europe Customer Support Center
 Fax: +49 (0) 180-530 85 86
 Email: europe.support@nsc.com
 Deutsch Tel: +49 (0) 69 9508 6208
 English Tel: +44 (0) 870 24 0 2171
 Français Tel: +33 (0) 1 41 91 8790

National Semiconductor
Asia Pacific Customer Support Center
 Email: ap.support@nsc.com

National Semiconductor
Japan Customer Support Center
 Fax: 81-3-5639-7507
 Email: jpn.feedback@nsc.com
 Tel: 81-3-5639-7560

www.national.com