



Raychem

TE Internal #: 7543793001

Hook Up Wire, Spec 99M, 600V Voltage Rating, White Wire Color, 18AWG Wire Size, .82mm² Wire Size, Operating Temperature Range -65 – 125 °C

[View on TE.com >](#)

Wire & Cable > Hook Up Wire



Cable Type: **Spec 99M**

Voltage Rating: **600 V**

Wire Color: **White**

Insulation Material: **Radiation-Crosslinked, Modified Polyester**

Conductor Material: **Tin-Plated Copper**

Features

Product Type Features

Product Type	Cable
Product Classification	Cable - Spec 99 & 100
Cable Style	Primary
Cable Type	Spec 99M

Configuration Features

Number of Conductors	1
Number of Strands	19

Electrical Characteristics

Voltage Rating	600 V
----------------	-------

Body Features

Wire Color	White
Insulation Material	Radiation-Crosslinked, Modified Polyester
Conductor Material	Tin-Plated Copper

Dimensions

Wire Diameter	1.55 mm[.061 in]
Overall Outside Diameter	1.75 mm[.0689 in]
Conductor Diameter	1.27 mm[.05 in]



Cable Insulation Thickness	.15 mm[.006 in]
----------------------------	-----------------

Strand Size	30 AWG
-------------	--------

Wire Size	.82 mm ²
-----------	---------------------

Usage Conditions

Operating Temperature Range	-65 – 125 °C
-----------------------------	--------------

Other

Wire Source	United Kingdom
-------------	----------------

Product Compliance

[For compliance documentation, visit the product page on TE.com>](#)

EU RoHS Directive 2011/65/EU	Compliant
------------------------------	-----------

EU ELV Directive 2000/53/EC	Compliant
-----------------------------	-----------

China RoHS 2 Directive MIIT Order No 32, 2016	No Restricted Materials Above Threshold
---	---

EU REACH Regulation (EC) No. 1907/2006	Current ECHA Candidate List: JUN 2020 (209) Candidate List Declared Against: JUN 2020 (209) Does not contain REACH SVHC
--	---

Halogen Content	Out of Scope - excluded from Halogen requirements
-----------------	---

Solder Process Capability	Not applicable for solder process capability
---------------------------	--

Product Compliance Disclaimer

This information is provided based on reasonable inquiry of our suppliers and represents our current actual knowledge based on the information they provided. This information is subject to change. The part numbers that TE has identified as EU RoHS compliant have a maximum concentration of 0.1% by weight in homogenous materials for lead, hexavalent chromium, mercury, PBB, PBDE, DBP, BBP, DEHP, DIBP, and 0.01% for cadmium, or qualify for an exemption to these limits as defined in the Annexes of Directive 2011/65/EU (RoHS2). Finished electrical and electronic equipment products will be CE marked as required by Directive 2011/65/EU. Components may not be CE marked. Additionally, the part numbers that TE has identified as EU ELV compliant have a maximum concentration of 0.1% by weight in homogenous materials for lead, hexavalent chromium, and mercury, and 0.01% for cadmium, or qualify for an exemption to these limits as defined in the Annexes of Directive 2000/53/EC (ELV). Regarding the REACH Regulation, the information TE provides on SVHC in articles for this part number is based on the latest European Chemicals Agency (ECHA) 'Guidance on requirements for substances in articles' posted at this URL: <https://echa.europa.eu/guidance-documents/guidance-on-reach>

Compatible Parts



TE Model / Part # 650075-000
D-436-37

Customers Also Bought

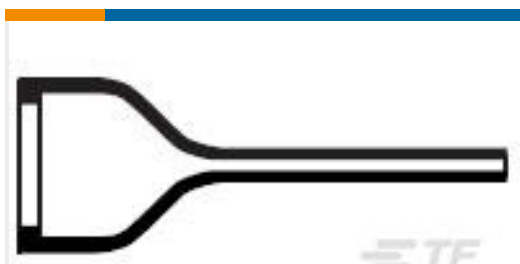

TE Model / Part #756165-000
202D921-100/180-0

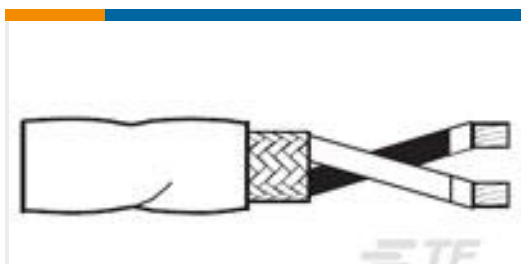

TE Model / Part #7220453001
99M1121-22-2/6-0

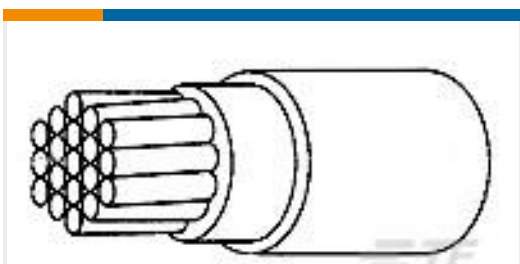

TE Model / Part #3396533001
99M0111-18-2

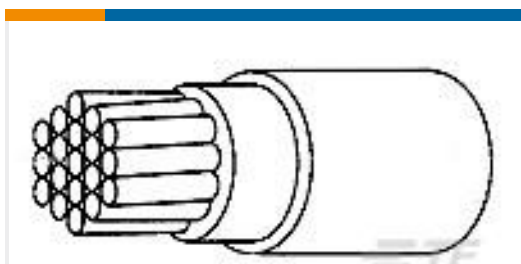

TE Model / Part #2645073001
99M0111-12-9



TE Model / Part #969147-000
B-150-03

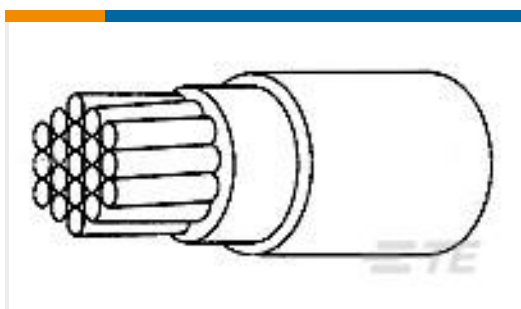

TE Model / Part #1266673001
99M0111-18-0



TE Model / Part #695992-000
B-058-01

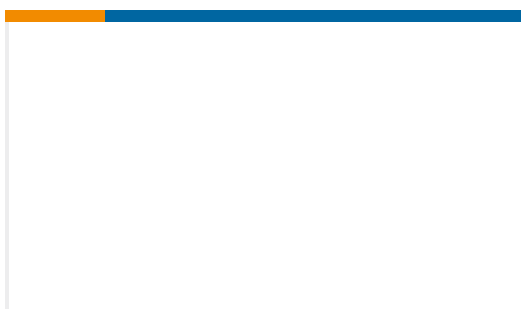

TE Model / Part #HC2246
TAPER PIN WG

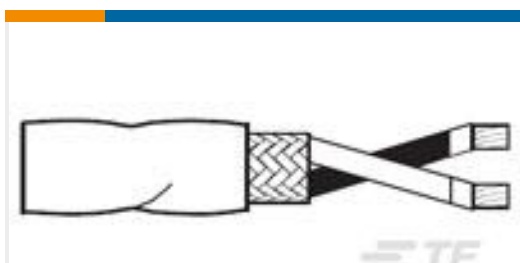

TE Model / Part #4112813001
99M1121-20-2/6-0

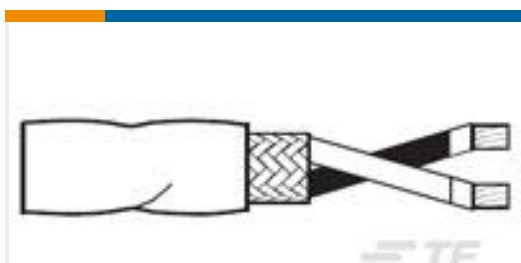

TE Model / Part #8811853001
99M1121-24-0/9-0

Documents

Product Drawings

[99M0111-18-9](#)

English

Datasheets & Catalog Pages

[1654025_Sec9_Type99M](#)

English

[Raychem Wire and Cable Quick Reference Guide](#)

English

99M0111-18-9

Hook Up Wire, Spec 99M, 600V Voltage Rating, White Wire Color, 18AWG Wire Size, .
82mm² Wire Size, Operating Temperature Range -65 – 125 °C

