



# Part No. 1000146

## Wi-Fi 6 & Wi-Fi 6E or CBRS/n78 Stamped Metal Embedded Antenna

2.4 / 5 GHz or 3.3 – 3.8 GHz

Supports: Wi-Fi applications, Wi-Fi 6/6E, Bluetooth, BLE, Zigbee, WLAN

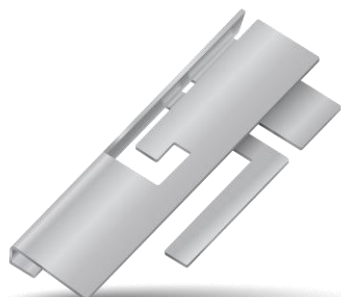

\*CBRS/n78 layout offered in Appendix 1

### Wi-Fi 6 & Wi-Fi 6E or CBRS/n78 Stamped Metal Embedded Antenna

2.400 GHz – 2.485 GHz;  
 3.300 - 3.800 GHz;  
 5.150 GHz – 5.825 GHz;  
 5.975 GHz – 7.125 GHz

#### KEY BENEFITS

##### Stay-in-Tune

KYOCERA AVX antenna technology provides superior RF field containment, resulting in less interaction with surrounding components.

##### Quicker Time-to-Market

By optimizing antenna size, performance and emissions, customer and regulatory specifications are more easily met.

##### Environmental Compliance

Products are the latest RoHS version compliant

#### APPLICATIONS

- Embedded design
- Gateway, Access Point
- Handheld
- Telematics
- Tracking
- Healthcare Applications (FDA ClassI)
- M2M, Industrial devices
- Smart Grid
- OBD-II
- Smart Home

KYOCERA AVX Stamped Metal series of Isolated Magnetic Dipole™ (IMD) antennas deliver on the key needs of device designers for higher functionality and performance in smaller/thinner designs. These innovative antennas provide compelling advantages for full WIFI 6 and WiFi 6E handheld devices, media players and other mobile devices. 1000146 Automotive A-series version offered.

#### Greater Flexibility

KYOCERA AVX first-in-class IMD technology enables you to develop concept designs that are more advanced and that deliver superior performance in reception critical applications. The 1000146 can also achieve CBRS/n78 performance with proper tuning and layout shown on Appendix 1.

#### Electrical Specifications

Typical Characteristics, on 125 x 45 mm PCB

Frequency (GHz)	2.400 – 2.485	5150 – 5.825	5925 - 7125	3.300– 3.800
Peak Gain	1.7 dBi	4.1 dBi	3.8 dBi	Refer to Appendix 1
Average Efficiency	81%	68%	64%	
VSWR Match	2.0:1 max	2.0:1 max	2.2:1 max	
Feed Point Impedance	50 ohms unbalanced			
Polarization	Linear			
Power Handling	0.5 Watt CW			
Additional Resources	<a href="#">Download Application Note</a>			

#### Mechanical Specifications & Ordering Part Number

Ordering Part Number	1000146
Size (mm)	17.85 x 6.9 x 4.3
Mounting	SMT
Weight (grams)	0.35
Packaging	Tape & Reel, 1000146 – 1,200 pieces per reel
Demo Board	1005456 (WiFi/WiFi6E) 1000146-03 (n78/CBRS)
Additional Resources	<a href="#">Download DXF, Gerber and 3D Fit Files</a>

Wi-Fi 6 & Wi-Fi 6E KYOCERA AVX Stamped Metal Embedded Antenna.  
 KYOCERA AVX produces a wide variety of standard and custom antennas to meet user needs.

### Antenna Dimensions

Typical antenna dimensions (mm)

Part Number	A	B	C
1000146	17.85 ± 0.3	6.9 ± 0.3	4.3 ± 0.4

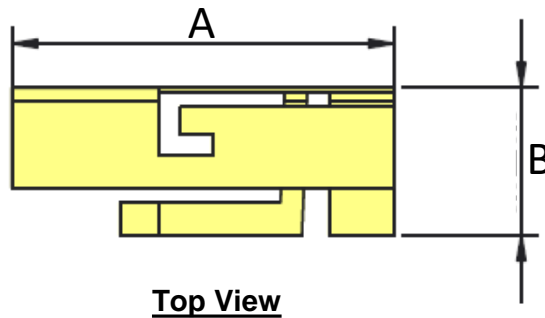
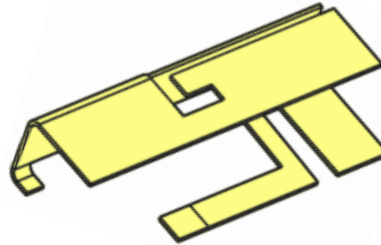

### Height

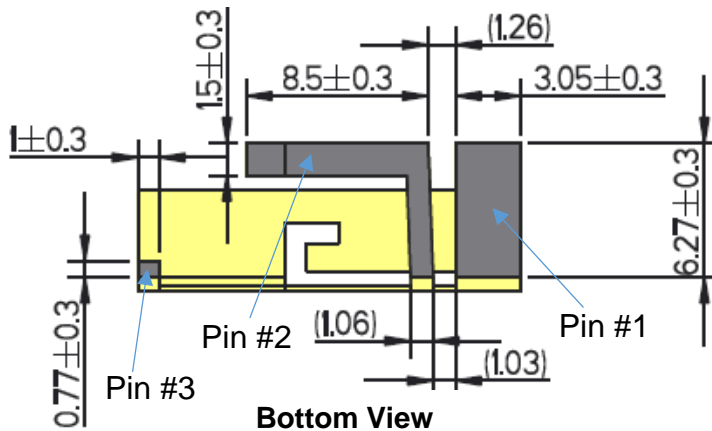

Pin	Description
1	Feed
2	Ground
3	Dummy Pad

Wi-Fi 6 & Wi-Fi 6E KYOCERA AVX Stamped Metal Embedded Antenna.  
KYOCERA AVX produces a wide variety of standard and custom antennas to meet user needs.

**Test Setup (1005456)**

Typical Performance on 125 x 45 mm PCB

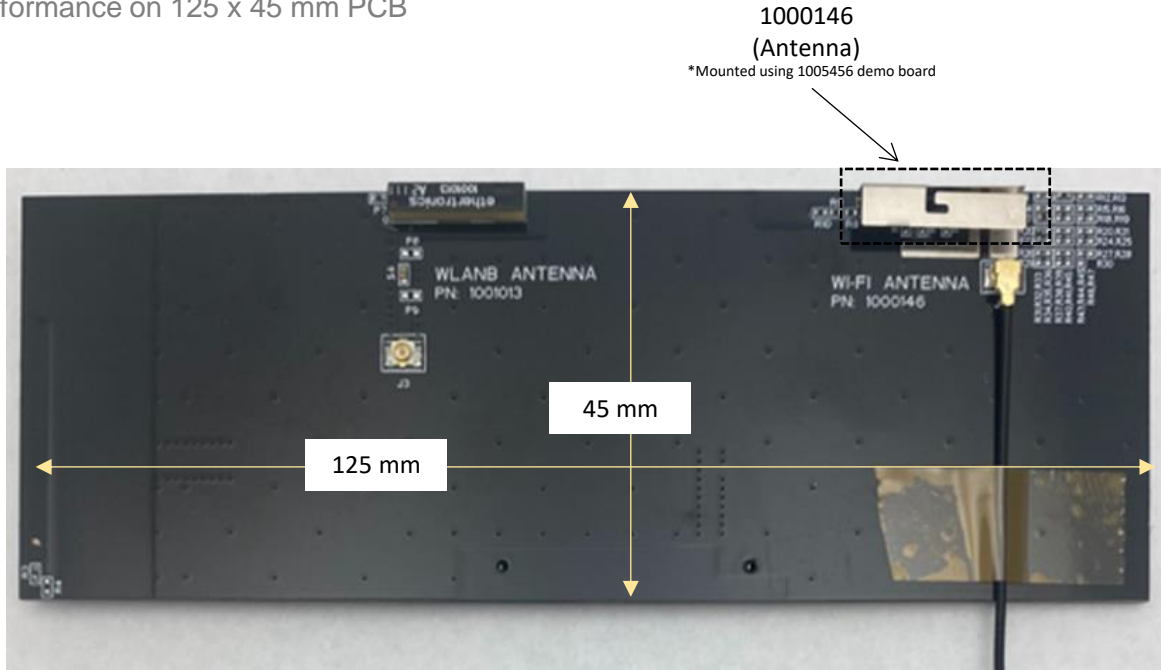

Wi-Fi 6 & Wi-Fi 6E KYOCERA AVX Stamped Metal Embedded Antenna.  
 KYOCERA AVX produces a wide variety of standard and custom antennas to meet user needs.

**VSWR, Efficiency, and Peak Gain Plots**

Typical Performance on 125 x 45 mm PCB

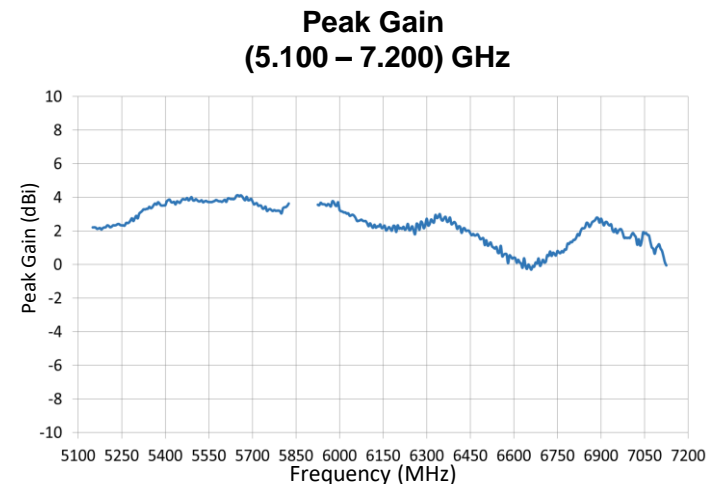
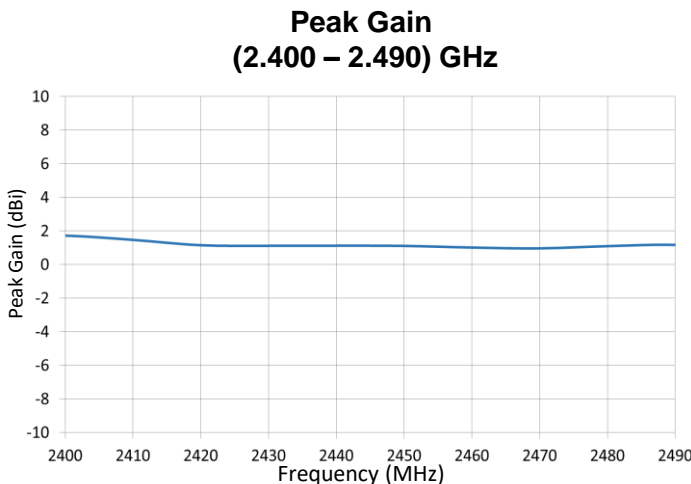
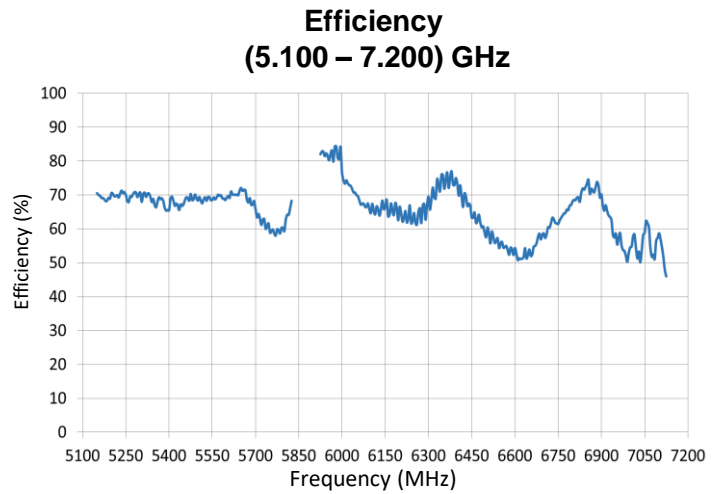
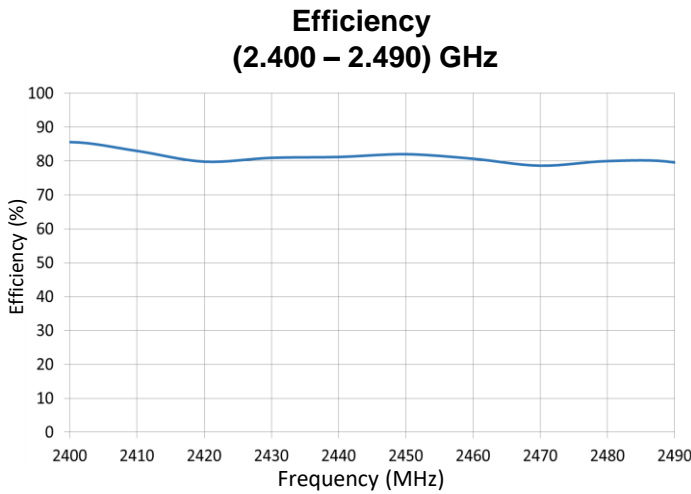
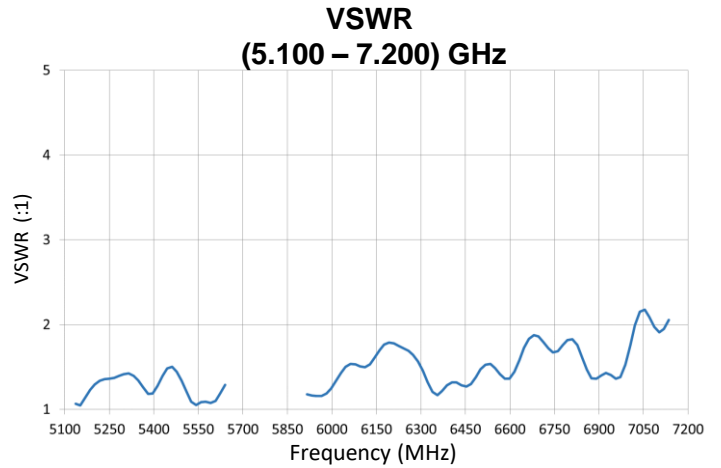
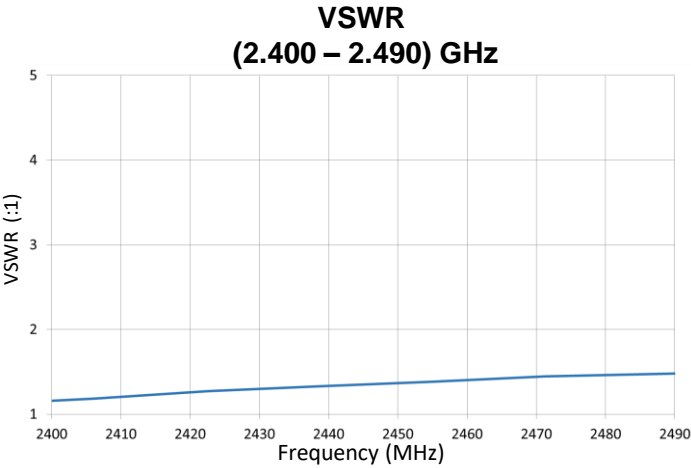

Wi-Fi 6 & Wi-Fi 6E KYOCERA AVX Stamped Metal Embedded Antenna.  
 KYOCERA AVX produces a wide variety of standard and custom antennas to meet user needs.

### Antenna Radiation Patterns

Typical Performance on 125 x 45 mm PCB  
 Measured @ 2.440 GHz

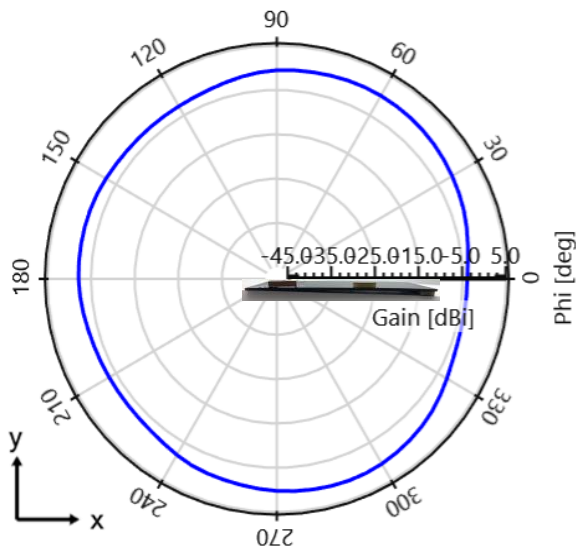
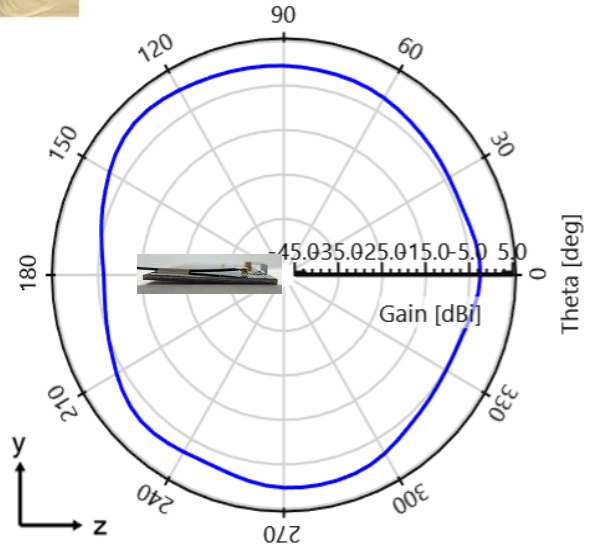
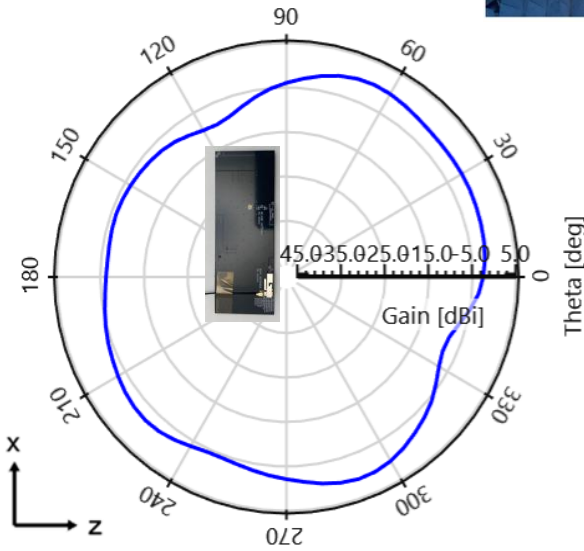
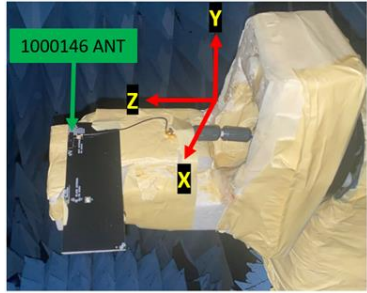

Wi-Fi 6 & Wi-Fi 6E KYOCERA AVX Stamped Metal Embedded Antenna.  
 KYOCERA AVX produces a wide variety of standard and custom antennas to meet user needs.

**Antenna Radiation Patterns**

Typical Performance on 125 x 45 mm PCB  
 Measured @ 5.550 GHz

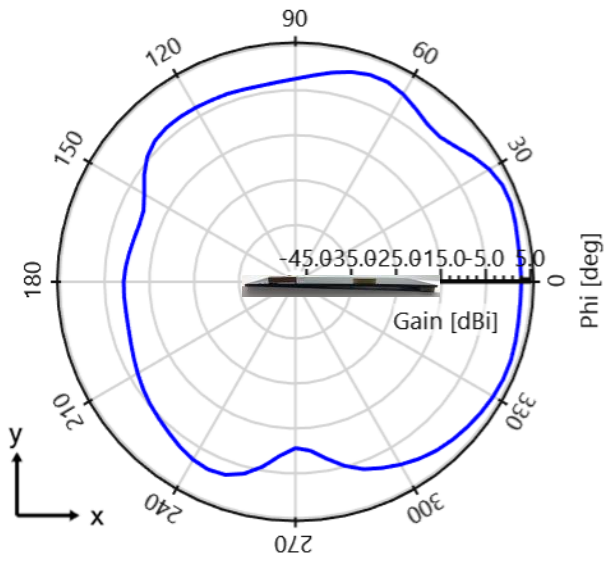
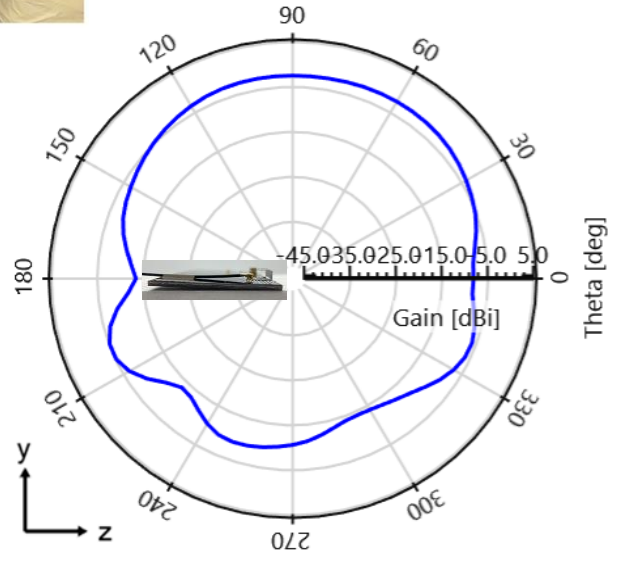
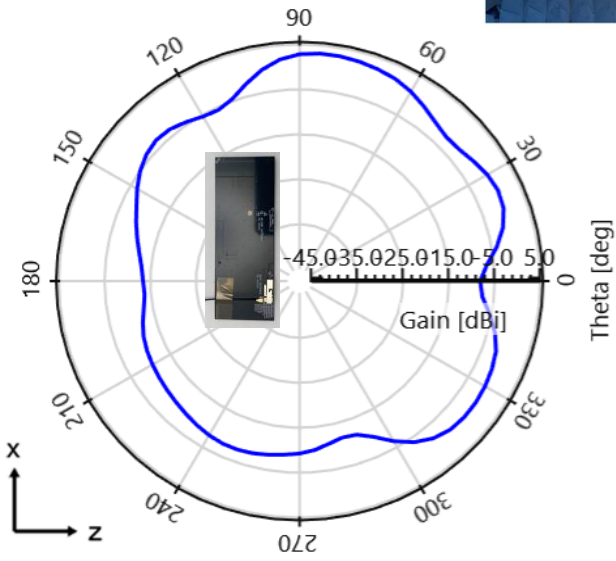
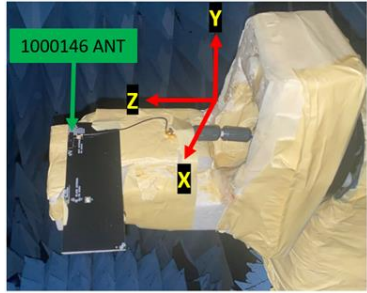

Wi-Fi 6 & Wi-Fi 6E KYOCERA AVX Stamped Metal Embedded Antenna.  
 KYOCERA AVX produces a wide variety of standard and custom antennas to meet user needs.

**Antenna Radiation Patterns**

Typical Performance on 125 x 45 mm PCB  
 Measured @ 6.425 GHz

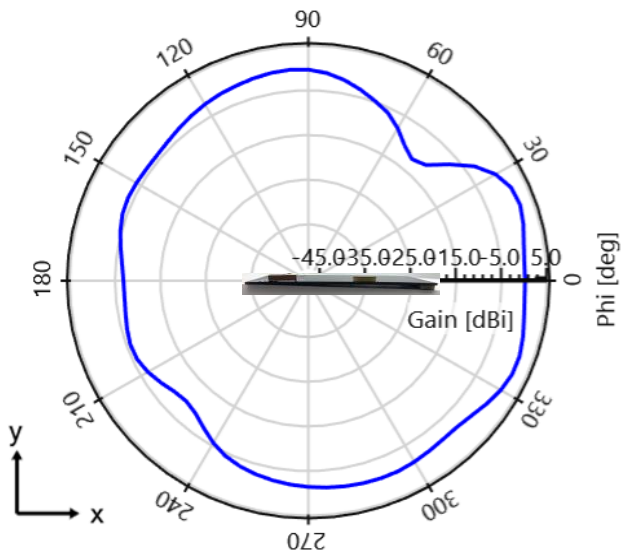
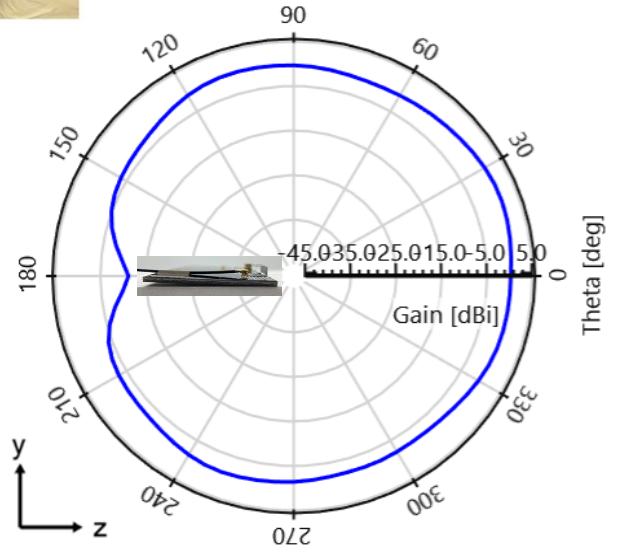
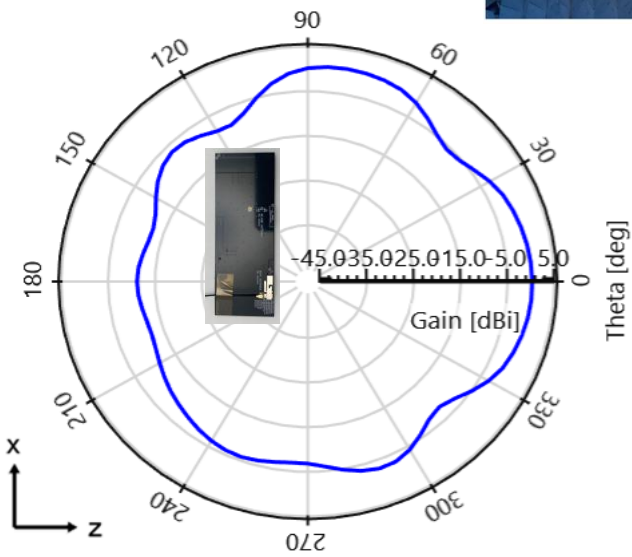
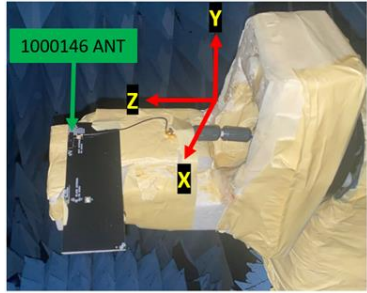

Wi-Fi 6 & Wi-Fi 6E KYOCERA AVX Stamped Metal Embedded Antenna.  
KYOCERA AVX produces a wide variety of standard and custom antennas to meet user needs.

### Antenna Layout (Minor Tuning Layout)

Typical layout dimensions (mm)

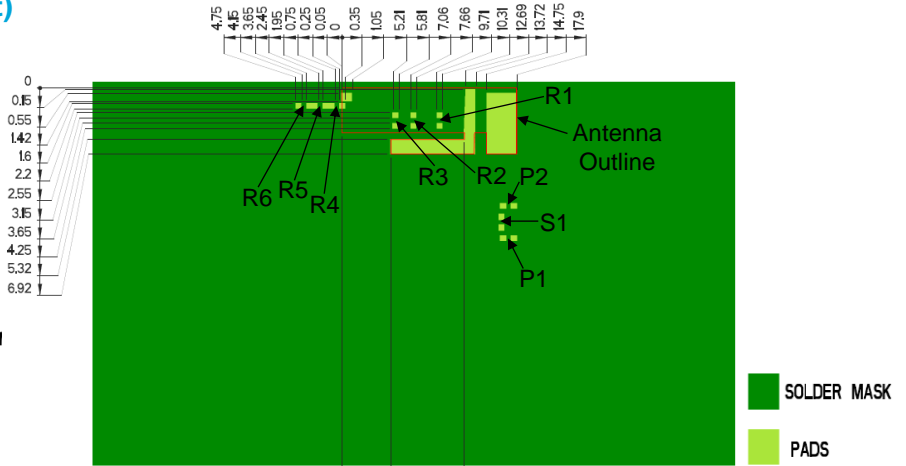
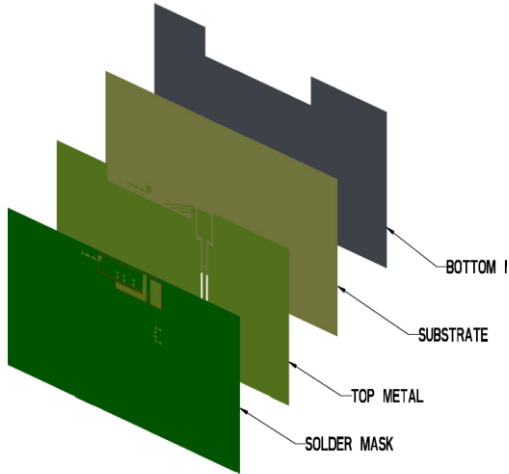

Note:  
Layout has minor tuning capabilities to allow for small antenna footprint.

#### Pin Descriptions

Pin#	Description
1	Feed
2	Ground
3	Dummy Pad

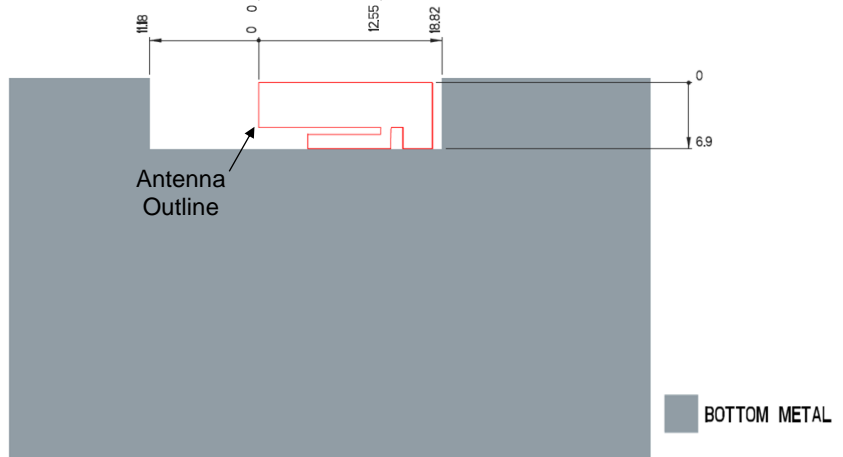
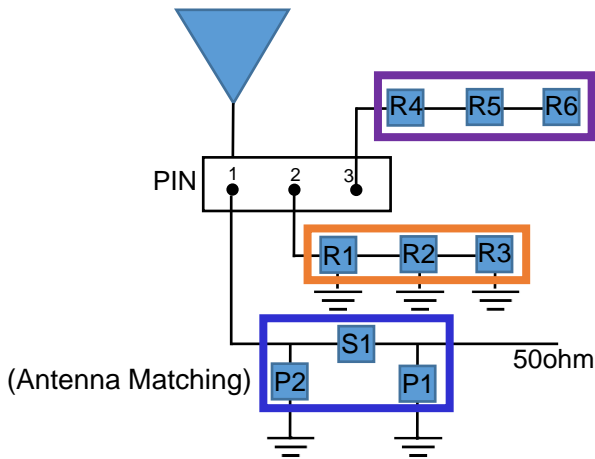
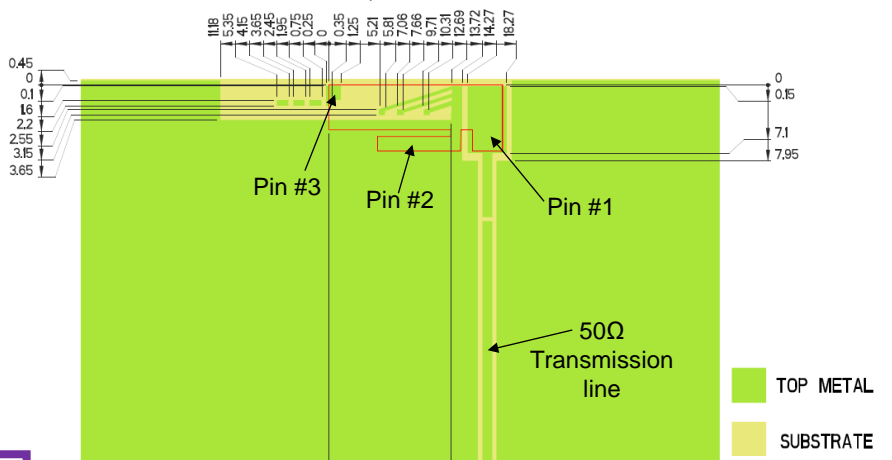

#### Antenna Matching & Tuning Component Values

	P1	S1	P2	R1 – R3	R4 – R6
Default Values	DNI	0Ω	DNI	DNI	DNI
Component Tolerance	N/A	N/A	N/A	N/A	N/A



Wi-Fi 6 & Wi-Fi 6E KYOCERA AVX Stamped Metal Embedded Antenna.  
 KYOCERA AVX produces a wide variety of standard and custom antennas to meet user needs.

### Antenna Layout (Major Tuning Layout)

Typical layout dimensions (mm)

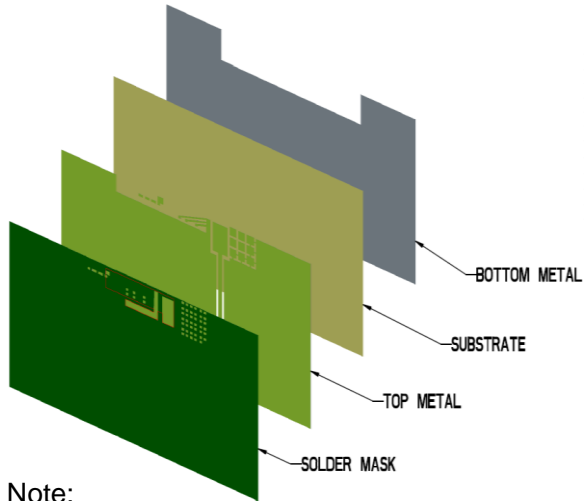

Note:  
 Layout has Major tuning capabilities to allow for robust tuning after board spin, instructions on [Antenna Matching Structure](#) page.

#### Pin Descriptions

Pin#	Description
1	Feed
2	Ground
3	Dummy Pad

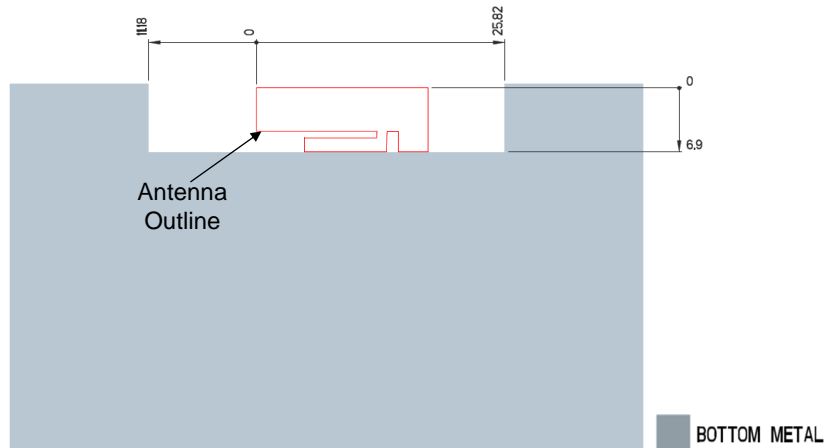
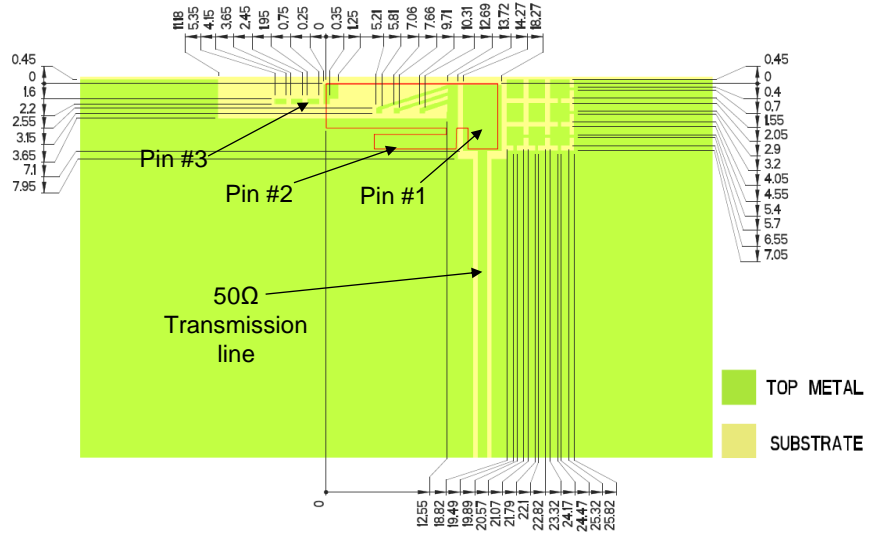
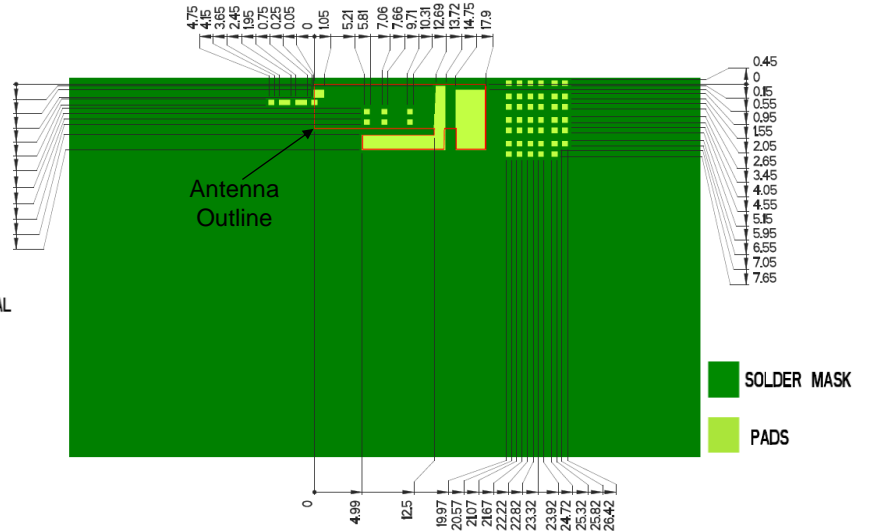

Wi-Fi 6 & Wi-Fi 6E KYOCERA AVX Stamped Metal Embedded Antenna.  
KYOCERA AVX produces a wide variety of standard and custom antennas to meet user needs.

### Antenna Matching Structure (Major Tuning Structure)

Typical matching values on 125 x 45 mm PCB

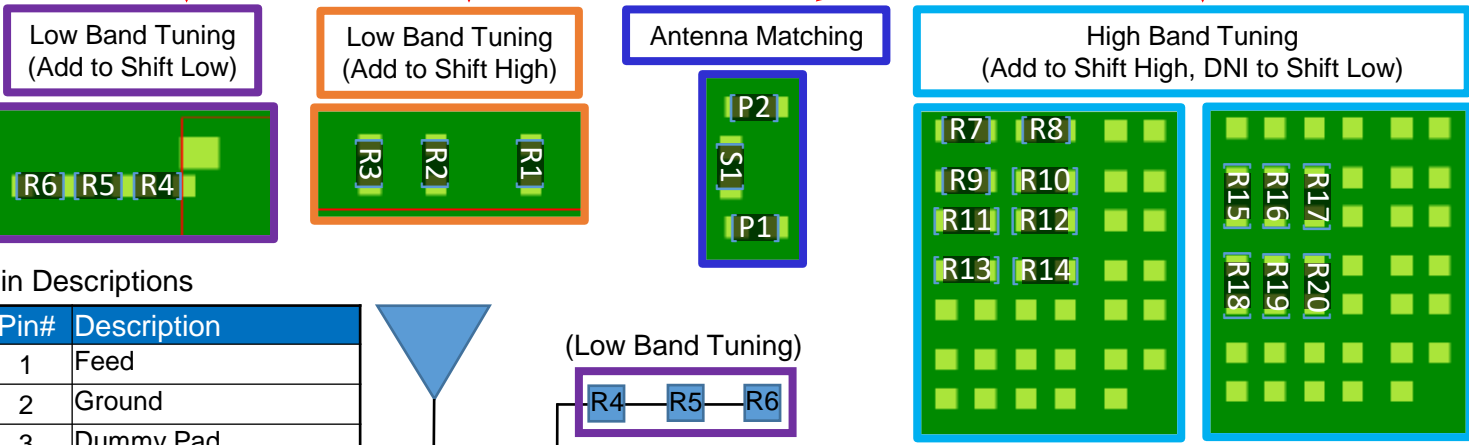
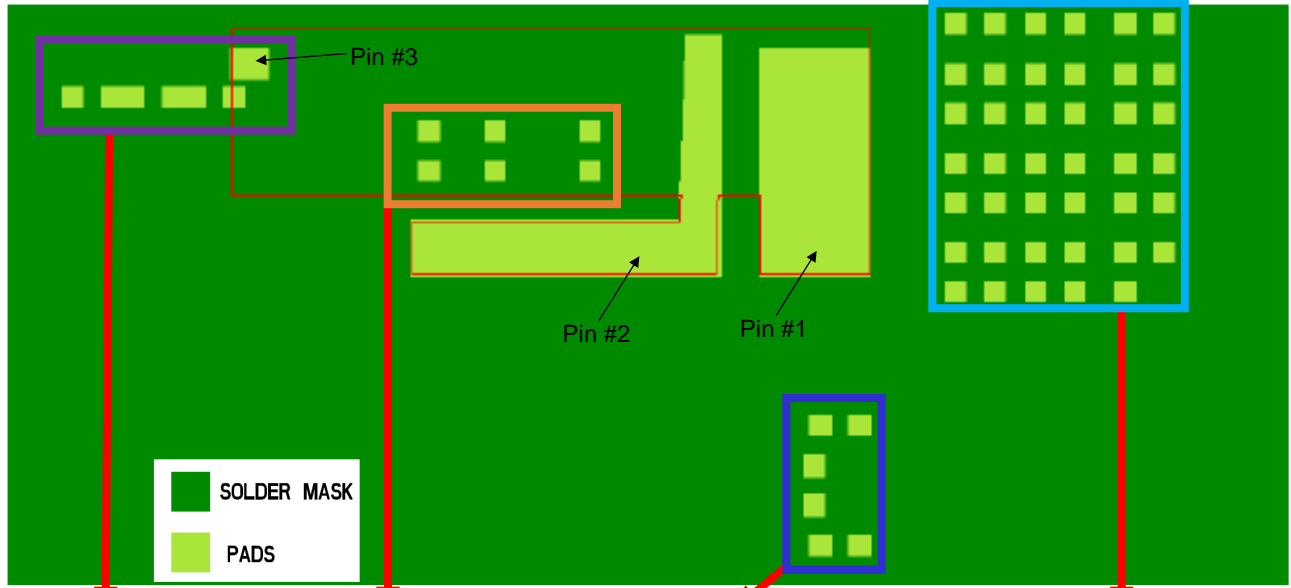

#### Pin Descriptions

Pin#	Description
1	Feed
2	Ground
3	Dummy Pad

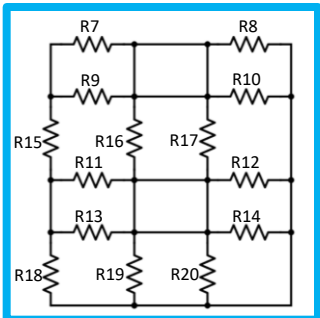
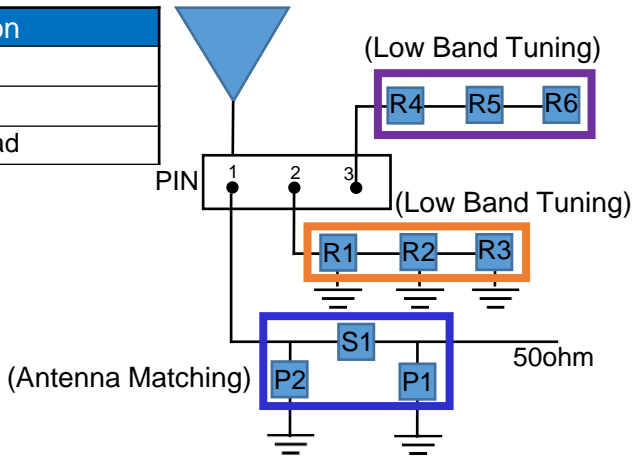

\*Extend ground towards antenna feed with 0Ω component(s). R7- R20 can improve high band bandwidth/ performance with ground coupling.

	P1	S1	P2	R1 – R3	R4 – R6	R7 – R14	R15 - R20
Default Values	DNI	0Ω	DNI	DNI	DNI	DNI	DNI
Tolerance	N/A	N/A	N/A	N/A	N/A	N/A	N/A

Appendix 1 CBRS/n78 KYOCERA AVX Stamped Metal Embedded Antenna.  
 KYOCERA AVX produces a wide variety of standard and custom antennas to meet user needs.

# Appendix 1

Appendix 1 gives instructions on how to achieve CBRS/n78 performances through layout and impedance matching network.  
**(3.300 – 3.800 GHz)**

Frequency (GHz)	3.300 – 3.800
Peak Gain	4.21 dBi
Average Efficiency	76%
VSWR Match	2.0:1 max
Feed Point Impedance	50 ohms unbalanced
Polarization	Linear
Power Handling	0.5 Watt CW

\*Data shown above has Appendix 1 matching applied on (1000146-03) 100 x 50 mm pcb.

Appendix 1 CBRS/n78 KYOCERA AVX Stamped Metal Embedded Antenna.  
KYOCERA AVX produces a wide variety of standard and custom antennas to meet user needs.

**Appendix 1 (1000146-03)**

Typical Performance on 100 x 50 mm PCB



Appendix 1 CBRS/n78 KYOCERA AVX Stamped Metal Embedded Antenna.  
 KYOCERA AVX produces a wide variety of standard and custom antennas to meet user needs.

**Appendix 1 VSWR and Efficiency Plots**  
 Typical Performance on 100 x 50 mm PCB



**VSWR**

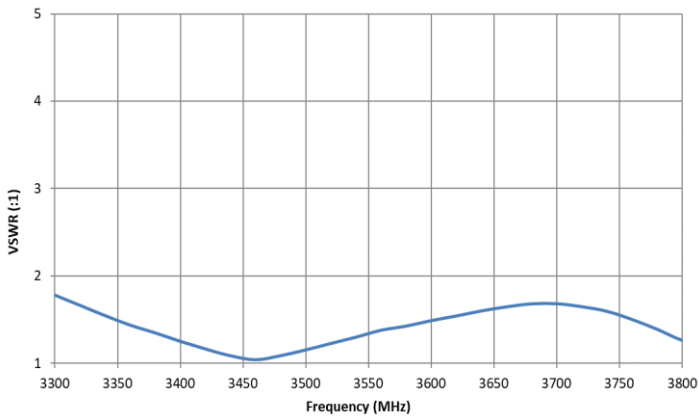

**Efficiency**

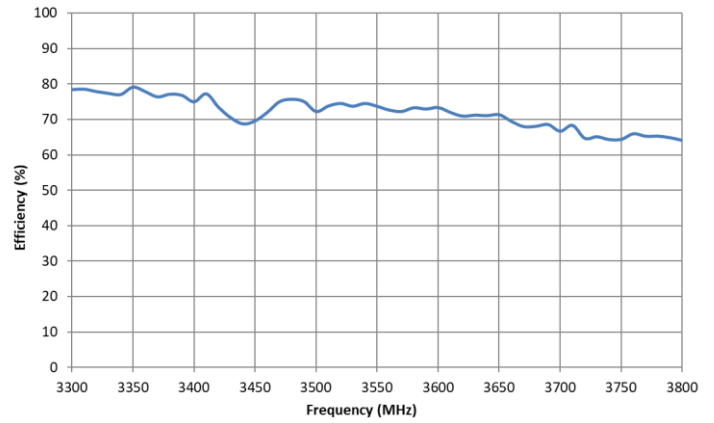

**Peak Gain**

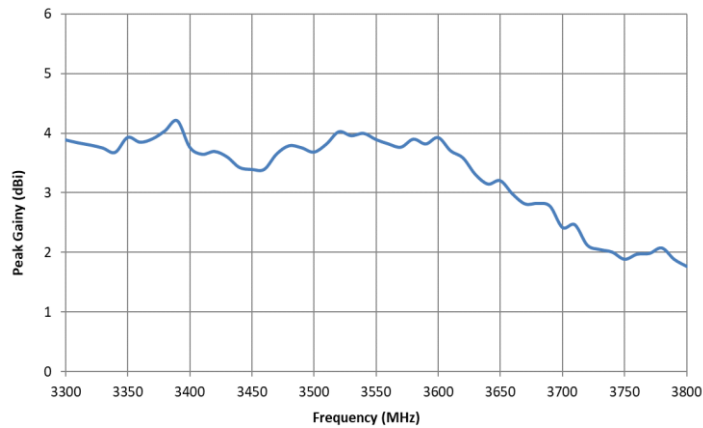

Appendix 1 CBRs/n78 KYOCERA AVX Stamped Metal Embedded Antenna.  
 KYOCERA AVX produces a wide variety of standard and custom antennas to meet user needs.

Appendix 1 Antenna Radiation Patterns

Typical Performance on 100 x 50 mm PCB  
 Measured @ 3500 MHz



Measured at 3500 MHz

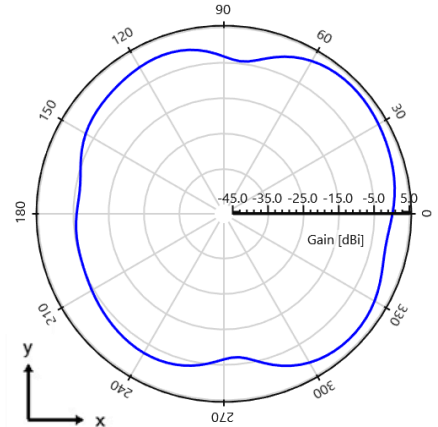
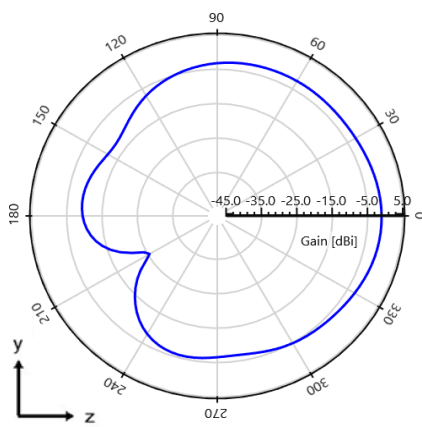
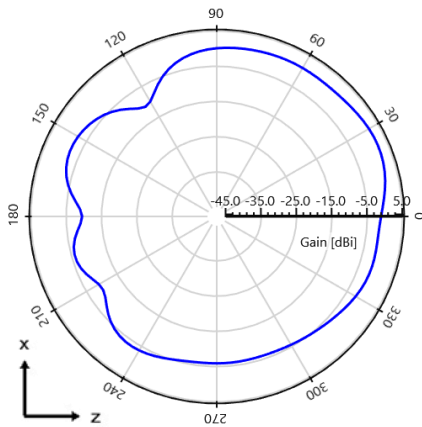

Appendix 1 CBRs/n78 KYOCERA AVX Stamped Metal Embedded Antenna.  
KYOCERA AVX produces a wide variety of standard and custom antennas to meet user needs.

**Antenna Layout (CBRS/n78 performances)**

Typical layout dimensions (mm)

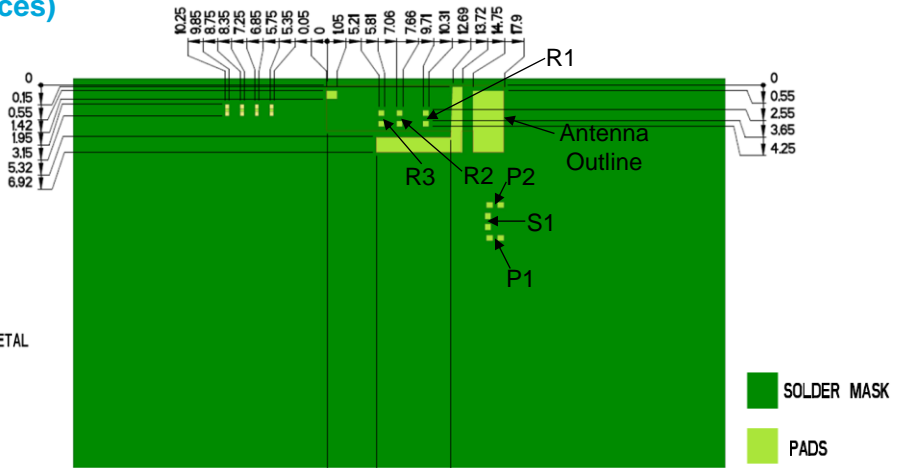
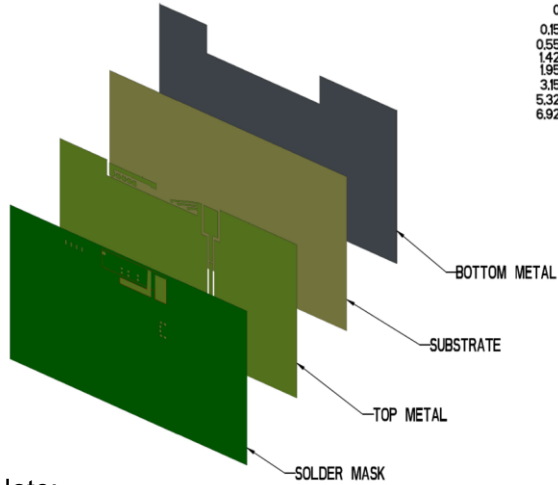

Note:  
Layout has minor tuning capabilities to allow for small antenna footprint.

**Pin Descriptions**

Pin#	Description
1	Feed
2	Ground
3	Dummy Pad

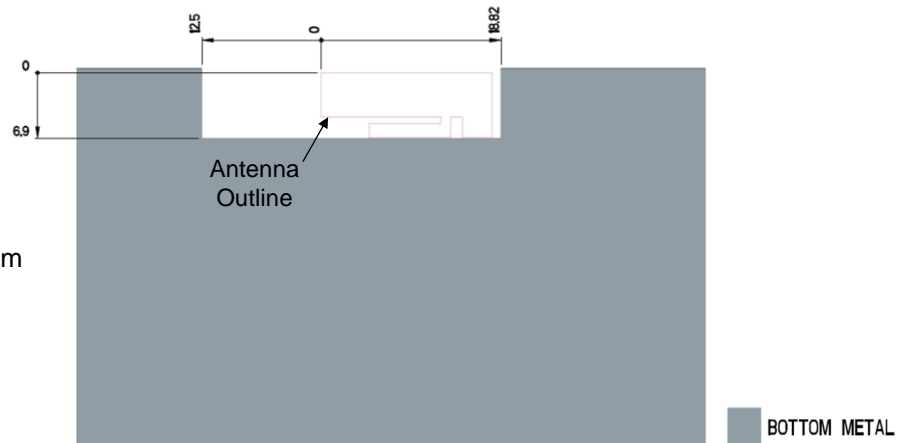
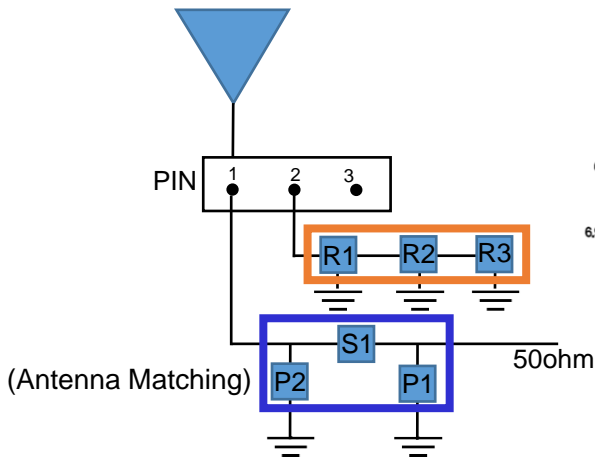
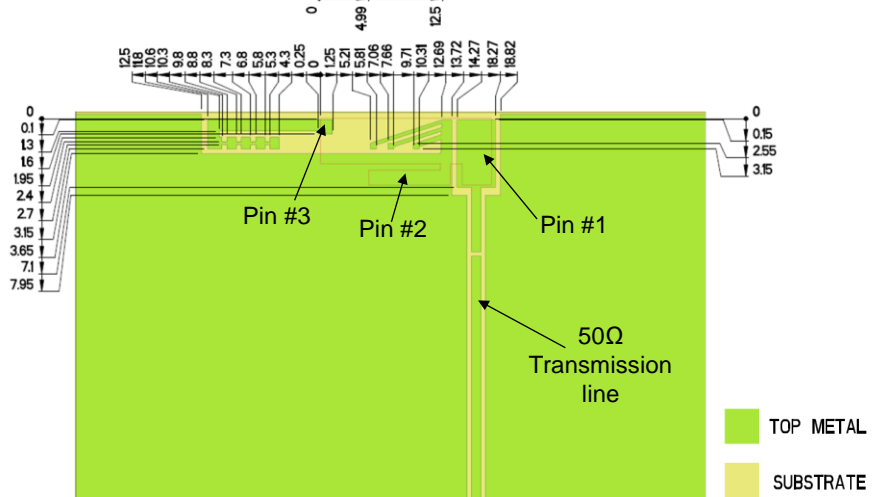

**Antenna Matching & Tuning Component Values**

	P1	S1	P2	R1 – R3
Default Values	DNI	1.5 nH	0.8 pF	DNI
Component Tolerance	N/A	(+/-0.05)	(+/-0.05)	N/A

Appendix 1 CBRS/n78 KYOCERA AVX Stamped Metal Embedded Antenna.  
 KYOCERA AVX produces a wide variety of standard and custom antennas to meet user needs.

### Antenna Matching Structure

Typical matching values on 100 x 50 mm PCB

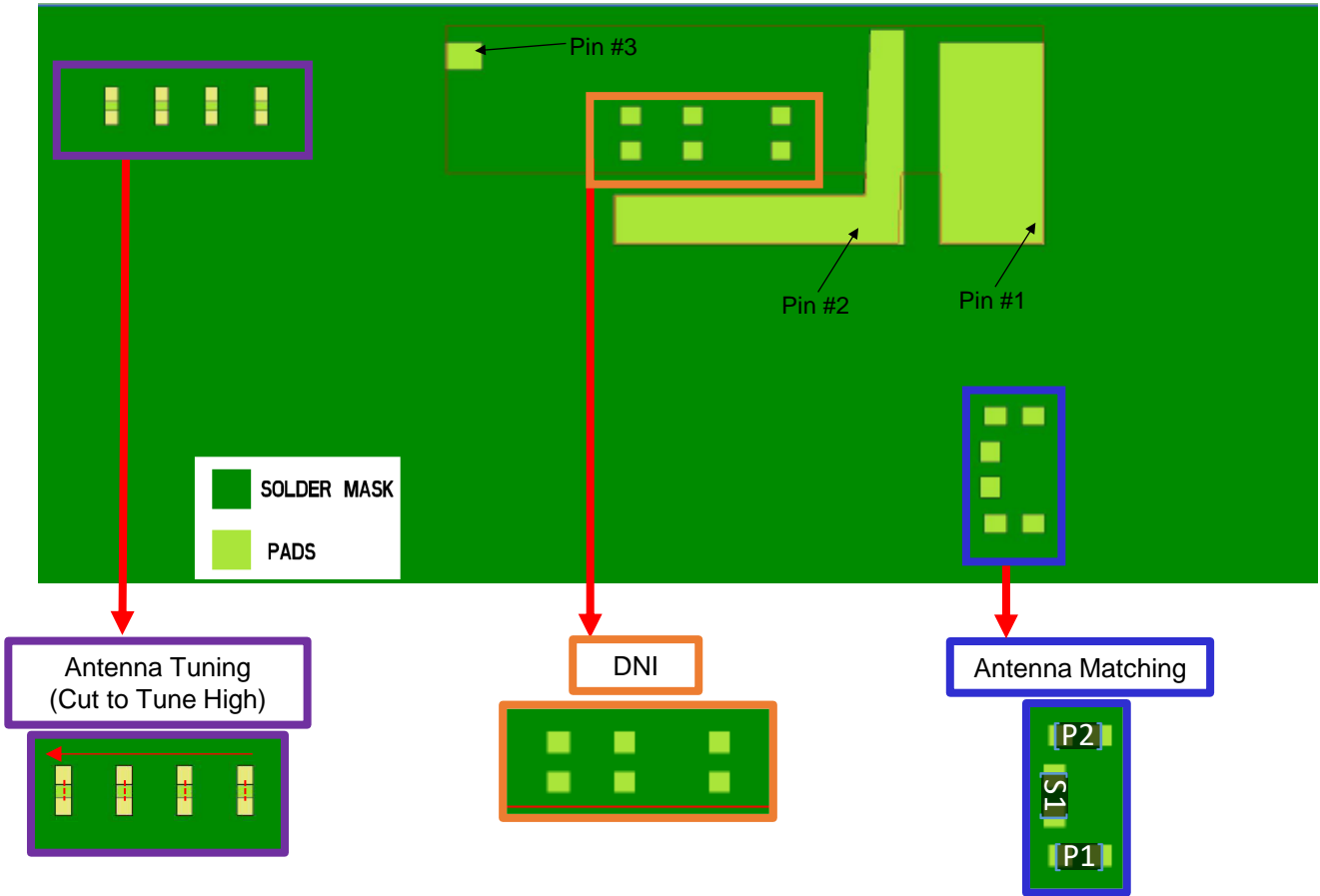

#### Pin Descriptions

Pin#	Description
1	Feed
2	Ground
3	Dummy Pad

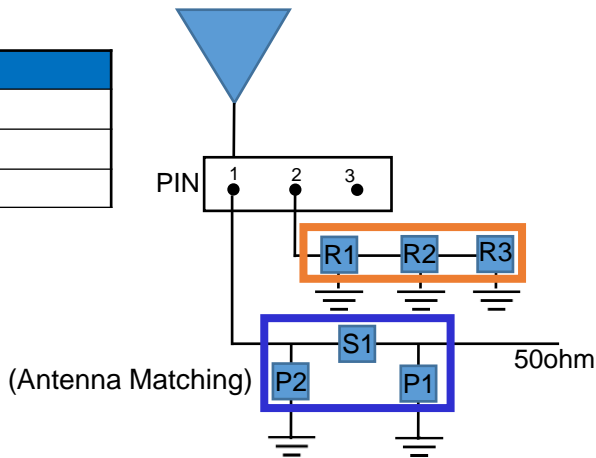

#### Antenna Matching & Tuning Component Values

	P1	S1	P2	R1 – R3
Default Values	DNI	1.5 nH	0.8 pF	DNI
Component Tolerance	N/A	(+/-0.05)	(+/-0.05)	N/A



Wi-Fi 6 & Wi-Fi 6E KYOCERA AVX Stamped Metal Embedded Antenna.  
KYOCERA AVX produces a wide variety of standard and custom antennas to meet user needs.

## Additional Resources – 1000146 CBRS / 5G NR n78 Stamped Metal Embedded Antenna

**Application Note:**

[https://www.kyocera-avx.com/docs/techinfo/ApplicationNotes/Antenna-AppNotes/AVX-E\\_AppNote-1000146.pdf](https://www.kyocera-avx.com/docs/techinfo/ApplicationNotes/Antenna-AppNotes/AVX-E_AppNote-1000146.pdf)

**3D Fit File:**

[https://www.kyocera-avx.com/download/antennas/ME-FIT/1000146\\_ME-fit.zip](https://www.kyocera-avx.com/download/antennas/ME-FIT/1000146_ME-fit.zip)

**DXF File:**

[https://www.kyocera-avx.com/download/antennas/3D-DXF/1000146-03\\_3D-DXF.zip](https://www.kyocera-avx.com/download/antennas/3D-DXF/1000146-03_3D-DXF.zip)

**Gerber File:**

[https://www.kyocera-avx.com/download/antennas/GERBER/1000146-03\\_GERBERS.zip](https://www.kyocera-avx.com/download/antennas/GERBER/1000146-03_GERBERS.zip)

## Additional Resources – 1000146 Wi-Fi 6E / Bluetooth Tri-Band Metal Embedded Antenna

**Application Note:**

[https://www.kyocera-avx.com/docs/techinfo/ApplicationNotes/Antenna-AppNotes/AVX-E\\_AppNote-1000146.pdf](https://www.kyocera-avx.com/docs/techinfo/ApplicationNotes/Antenna-AppNotes/AVX-E_AppNote-1000146.pdf)

**3D Fit File:**

[https://www.kyocera-avx.com/download/antennas/ME-FIT/1000146\\_ME-fit.zip](https://www.kyocera-avx.com/download/antennas/ME-FIT/1000146_ME-fit.zip)

**DXF File**

Standard Layout : [https://www.kyocera-avx.com/download/antennas/3D-DXF/1004796\\_3D-DXF.zip](https://www.kyocera-avx.com/download/antennas/3D-DXF/1004796_3D-DXF.zip)

Extended Layout : [https://www.kyocera-avx.com/download/antennas/3D-DXF/1000146-02\\_3D-DXF.zip](https://www.kyocera-avx.com/download/antennas/3D-DXF/1000146-02_3D-DXF.zip)

**Gerber File:**

Standard Layout : [https://www.kyocera-avx.com/download/antennas/GERBER/1000146-01\\_GERBERS.zip](https://www.kyocera-avx.com/download/antennas/GERBER/1000146-01_GERBERS.zip)

Extended Layout : [https://www.kyocera-avx.com/download/antennas/GERBER/1000146-02\\_GERBERS.zip](https://www.kyocera-avx.com/download/antennas/GERBER/1000146-02_GERBERS.zip)