







-  Flyback transformers designed for PoE (IEEE802.3af) powered devices with up to 3 Watts
-  Designed for 250kHz switching frequency (continuous mode) with input of 33 - 57V
-  Low Leakage Inductance
-  Hipot voltage: 1500Vrms
-  Operating temperature -40°C to +85°C.
-  RoHS compliant version is available
-  Custom design is also available



ELECTRICAL SPECIFICATION @ 25°C

Part Number	RoHS Part Number	Turns Ratio		Inductance at 0A (uH ± 10%)	Inductance at Ipk (uH Min)	Leakage Inductance (nH Max)	DCR (mOhm Max)			Ipk (A)	Secondary Output
		Pri : Sec	Pri : Bias				Pri	Bias	Sec		
835-00842	835-00842F	1 : 0.19	1 : 0.70	310	279.0	4.75	1020	2010	66	0.3	Vout=3.3V,0.91A
835-00843	835-00843F	1 : 0.28	1 : 0.70	310	279.0	4.50	1020	2010	118	0.3	Vout=5.0V,0.6A
835-00844	835-00844F	1 : 0.70	1 : 0.70	310	279.0	4.25	1040	2010	700	0.3	Vout=12V,0.25A

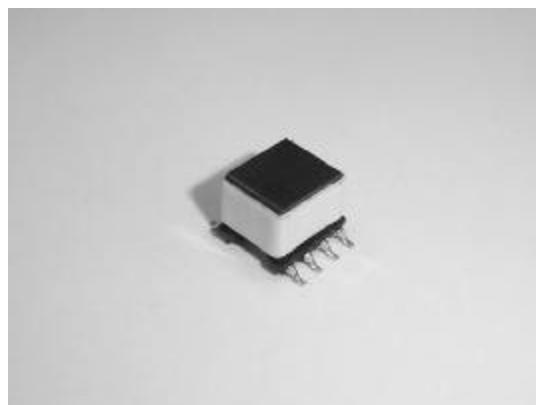
Notes:

1. Inductance is measured at 250kHz, 0.1Vrms, 0Adc.
2. Peak primary current, Ipk, is drawn at minimum input voltage.
3. DCR for the secondary is per winding.
4. Leakage Inductance measured between pins 3 and 4 with all other pins shorted.
5. Turns ratio is with the secondary windings connected in parallel.
6. Output of the secondary is with the windings connected in parallel. Bias winding output is 12V, 20mA.
7. Operating temperature range: -40°C to +85°C. The part temperature (ambient temperature + temperature rise) should not exceed the upper limit of the operating temperature under worst case operating conditions. Circuit design, component placement, PWB trace size and thickness, airflow and other cooling provisions all affect the part temperature. Part temperature should be verified in the end application.



MECHANICAL DIMENSIONS

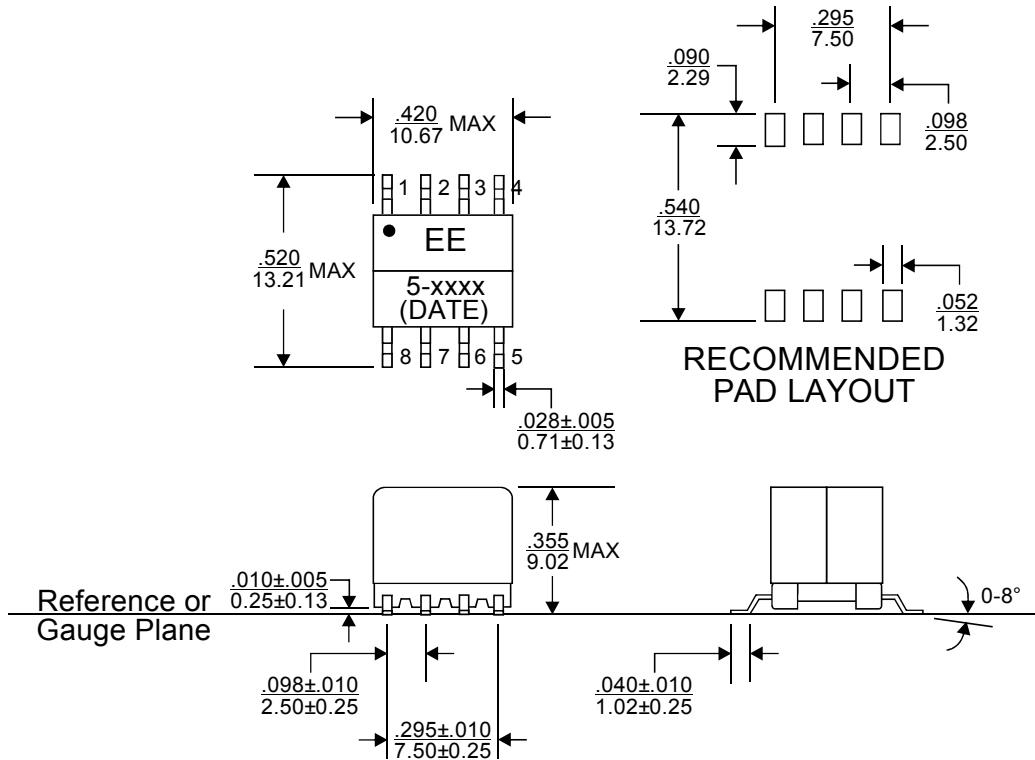

Notes:

8. All dimensions are specified in $\frac{\text{inches}}{\text{mm}}$ with higher precedence in inches.
9. Unless otherwise specified, all tolerances are $\pm \frac{.010}{0.25}$.
10. Coplanarity: $\frac{.004}{0.10}$ max.
11. For RoHS compliant version, 835-0yyyyF, the part will be marked with "5-yyyyF", instead of "5-yyyy".

Weight (in gram)	: 2.2 typ.
Tape & Reel	: 350 / reel

SCHEMATICS

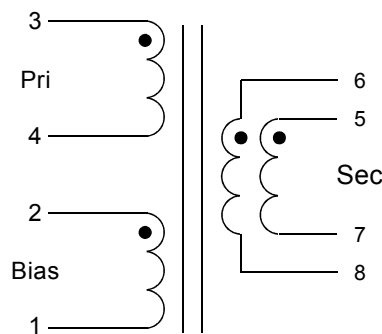

SCHEMATIC

FOR MORE INFORMATION, PLEASE CONTACT

HEADQUARTER
2/F Block A, Merit Industrial Centre,
94 Tokwawan Road, Kowloon,
Hong Kong
Tel: (852) 2765 3888
Fax: (852) 2954 3304
Email: eempl@eleceltek.com

Website: <http://www.eleceltek.com>

Information herein is for reference only and subject to change without notice. It does not constitute any representation, warranty or commitment of the company in respect of the products in any aspect. All logos, brands and product names mentioned herein are trademarks or registered trademarks of their respective owners. The company does not assume any liability arising out of the application or use of any product or circuit described herein. Copyrights 2006, E & E Magnetic Products Limited.