

## Wide Band Low Noise Amplifier 0.01GHz–50GHz



### Product Description

RLNA00M50GA is a wideband low noise amplifier with a frequency range of 0.01 to 50GHz.

The 1dB compression point of this amplifier is 21dBm. The typical small signal gain is 40dB with a gain flatness of  $\pm 5$ dB.

The power amplifier's input connector is 2.4mm and output connector is 2.4mm.

The operating temperature of this product is within -40 to +85°C.

### Features

- Wideband Low Noise Amplifier
- Small Signal Gain 40dB Typical
- Output P1dB 21dBm Typical
- Supply Voltage +12VDC
- 50 Ohm Matched Input/Output
- Gain Flatness +/-5dB

### Typical Applications

- Wireless Infrastructure
- Military and Aerospace Applications
- Test Instrumentation
- Radar Systems
- 5G Wireless Communications
- Microwave Radio Systems
- TR Modules
- Research and Development
- Cellular Base Stations

### Electrical Specifications (T<sub>A</sub>=+25°C)

Parameter	Min	Typ	Max	Min	Typ	Max	Units
Frequency Range		0.01 to 20			20 to 50		GHz
Small Signal Gain		45			35		dB
Gain Flatness		+/-3			+/-3		dB
Gain Variation Over Temperature (-40°C to +70°C)		+/-3			+/-3		dB
Input Return Loss		-15			-15		dB
Output Return Loss		-19			-15		dB
Noise Figure		4.5			6		dB
Output 1dB Compression Point (P1dB)		21			20		dBm
Saturated Output Power (Psat)		22			18		dBm
Supply Current		550	650		550	650	mA
Weight				0.3			lbs.
Impedance			50				Ohms
Input / Output Connectors				2.4mm (Input) – 2.4mm (Output)			
Package				Epoxy Sealed (Standard)			
				Hermetically Sealed (Optional)			

**Absolute Maximum Ratings**

Parameter	Rating
Positive Supply Voltage Range	+12VDC to +13VDC
*RF Input Power (RFIN)	Psat – Large Signal Gain

**Bias Up Procedure**

1. Connect ground
2. Connect input and output with 50 Ohm source/load.  
(In band VSWR < 1.9:1 or >10dB return loss.)
3. Connect positive supply and make sure power supply can handle max current.

**Bias Down Procedure**

1. Turn off power supply
2. Remove positive supply Connection
3. Remove RF Connection
4. Remove ground

**Environmental Specifications and Test Standards**

Parameter	Description
Operational Temperature	-40°C to +85°C (Case Temperature)
Storage Temperature	-55°C to +125°C
Thermal Shock	-40°C → +85°C (5 Cycles / 10 hours)
**Random Vibration	MIL-STD-202G Table 214-I, Test Condition Letter C 1.5 Hours Per Axis
High Temperature Burn In	Temperature +85°C for 72 Hours
Shock	1. Weight >20g, 50g Half sine wave for 11ms, Speed variation 3.44m/s 2. Weight <=20g, 100g Half sine wave for 6ms, Speed variation 3.75m/s 3. Total 18 times (6 directions, 3 repetitions per direction).
Altitude	Standard: 30,000 Ft (Epoxy Sealed Controlled Environment) Optional: Hermetically Sealed (60,000 ft. 1.0 PSI min)
Hermetically Sealed (Optional)	MIL-STD-883 (For Hermetically Sealed Units)

\*Maximum RF input power is set to assure safety of amplifier. Input power may be increased at own risk to achieve full power of amplifier. Please reference gain and power curves.

\*\*For vibration testing details please see additional information section.

**Typical Performance Plots**

**Input Return Loss vs Frequency @+25°C**

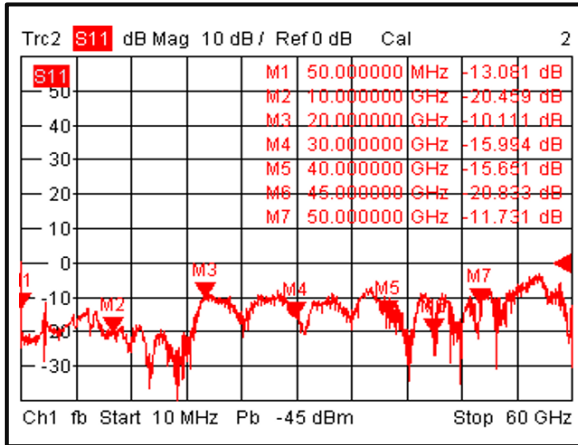

**Gain vs Frequency @+25°C**

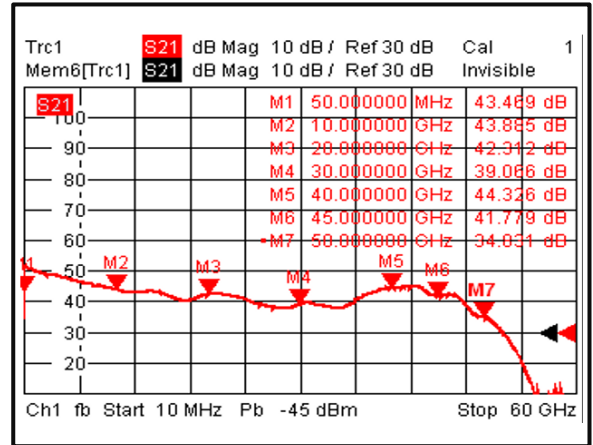

**Output Return Loss vs Frequency @+25°C**

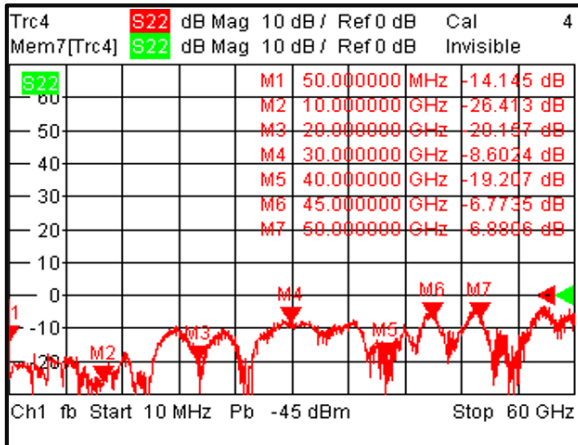

**Isolation vs Frequency @+25°C**

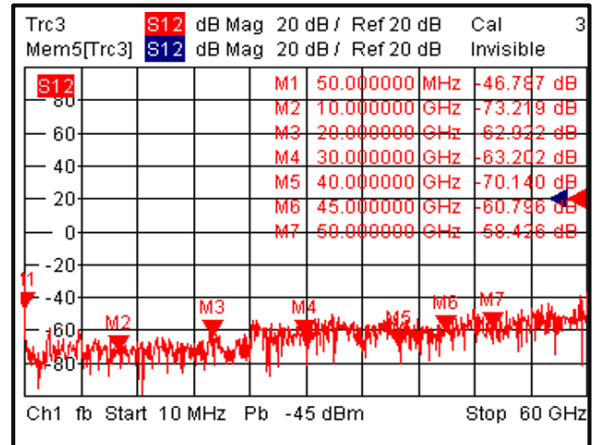

Note: Small signal VNA measurements include attenuators to protect equipment

**Typical Performance Plots**

**Gain vs Output Power**

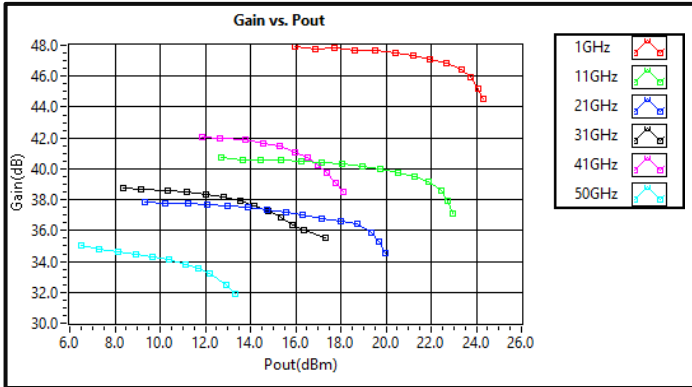

**Output vs Input Power**

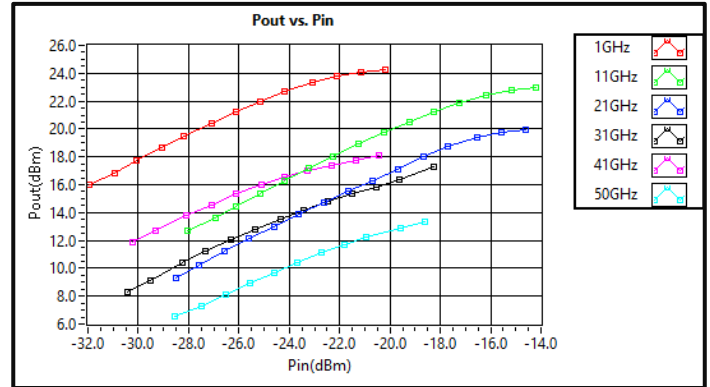

**PxdB vs Frequency**

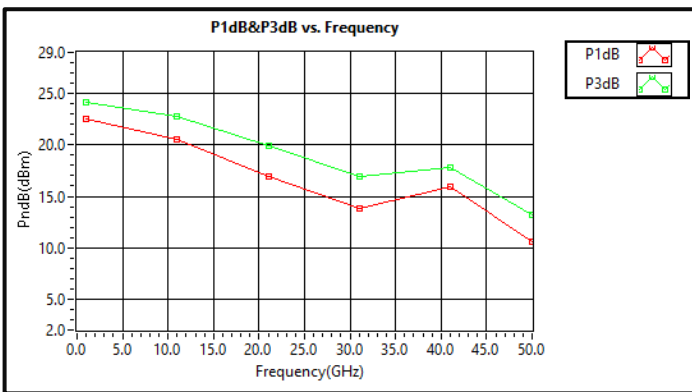

**Current vs Output Power**

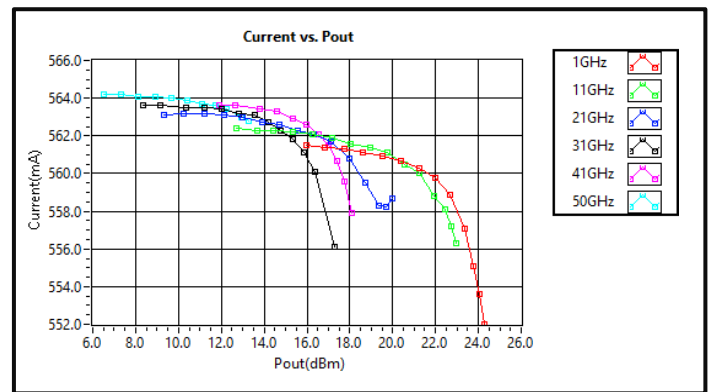

**Noise Figure vs Frequency**

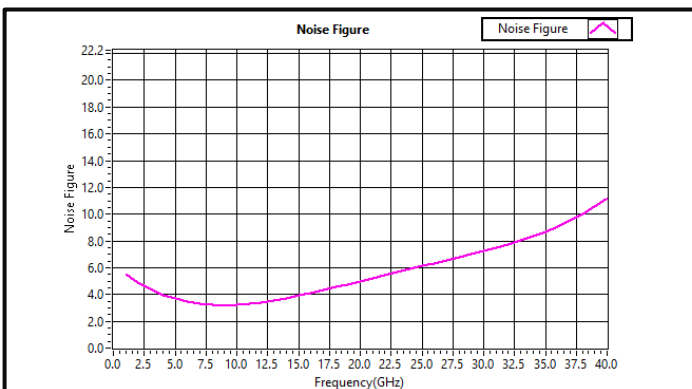

**OIP3 vs Frequency**

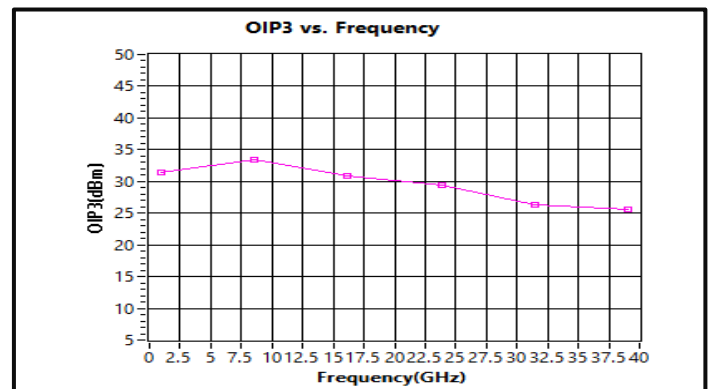

Typical Performance Plots

Left IM3 vs Output Power

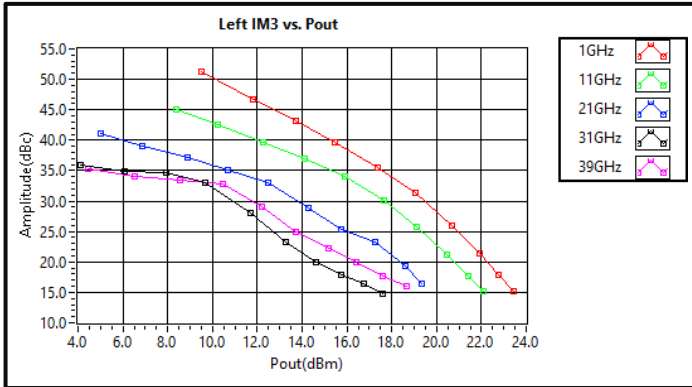

Right IM3 vs Output Power

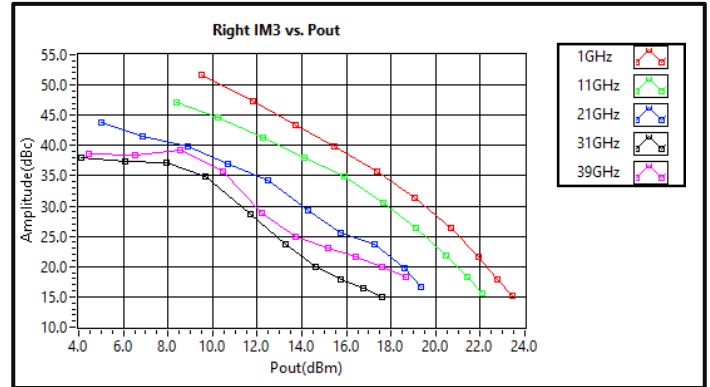

Delta IM3 vs Output Power

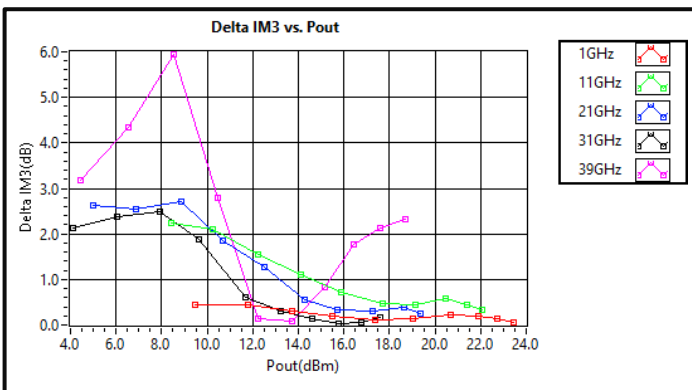

**Outline Drawing**

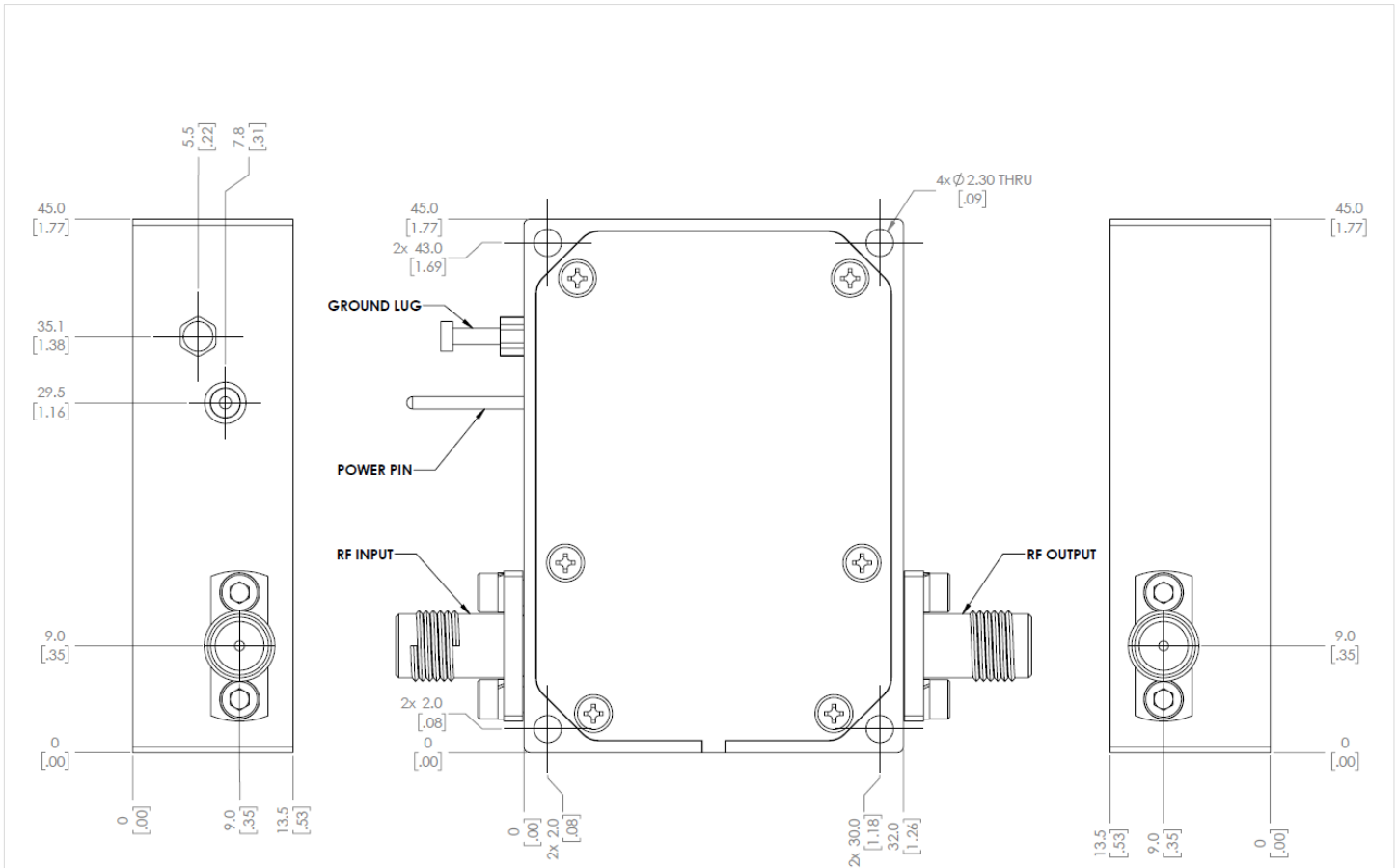

**Notes:**

1. Package Material: Aluminum and Copper
2. Plating: Gold
3. All dimensions are in millimeters [inches].
4. Tolerances  $\pm 0.25$  [0.010] unless otherwise specified.
5. Heat sink required during operation (sold separately). Matching heatsink is listed on our website. If customer would like to use their own cooling method, please make sure the amplifier will operate under the specs that listed in page 2 of this datasheet.

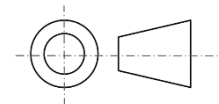

**Additional Information**

Documentation	Webpage
ESD Policy	<a href="https://rflambda.com/pdf/rflambda_esd_control.pdf">https://rflambda.com/pdf/rflambda_esd_control.pdf</a>
Heatsink Lookup Specifications	<a href="https://rflambda.com/search_heatsink.jsp">https://rflambda.com/search_heatsink.jsp</a>
Connector Torque Specifications	<a href="https://www.rflambda.com/pdf/Torque_Specifications.pdf">https://www.rflambda.com/pdf/Torque_Specifications.pdf</a>
Random Vibration Test Standard	<a href="https://www.rflambda.com/pdf/rflambda_random_vibration_MIL-STD-202G.pdf">https://www.rflambda.com/pdf/rflambda_random_vibration_MIL-STD-202G.pdf</a>

**Ordering Information**

Part Number	Modification	Description
RLNA00M50GA	Input connector 2.4mm and Output connector 2.4mm	0.01GHz-50GHz Power Amplifier
RAMP00M50GA	Input connector 2.4mm and Output connector 2.4mm	0.01GHz-50GHz AC Power Supplied Amplifier

**Amplifier Use**

Ensure that the amplifier input and output ports are safely terminated into a proper 50 ohm load before turning on the power. Never operate the amplifier without a load. A proper 50 ohm load is defined as a load with impedance less than 1.9:1 or return loss larger than 10dB relative to 50 Ohm within the specified operating band width.

Power Supply Requirements

Power supply must be able to provide adequate current for the amplifier. Power supply should be able to provide 1.5 times the typical current or 1.2 times the maximum current (whichever is greater).

In most cases, RF - Lambda amplifiers will withstand severe mismatches without damage. However, operation with poor loads is discouraged. If prolonged operation with poor or unknown loads is expected, an external device such as an isolator or circulator should be used to protect the amplifier.

Ensure that the power is off when connecting or disconnecting the input or output of the amp.

Prevent overdriving the amplifier. Do not exceed the recommended input power level.

Adequate heat-sinking required for RF amplifier modules. Please inquire.

Amplifiers do not contain Thermal protection, Reverse DC polarity protection or Over voltage protection with the exception of a few models. Please inquire.

Proper electrostatic discharge (ESD) precautions are recommended to avoid performance degradation or loss of functionality.

**What is not covered with warranty?**

Each RF - Lambda amplifier will go through power and temperature stress testing.

Since the die, ICs or MMICs are fragile, these are not covered by warranty. Any damage to these will NOT be free to repair.

**Important Notice**

The information contained herein is believed to be reliable. RF-Lambda makes no warranties regarding the information contained herein. RF-Lambda assumes no responsibility or liability whatsoever for any of the information contained herein. RF-Lambda assumes no responsibility or liability whatsoever for the use of the information contained herein. The information contained herein is provided "AS IS, WHERE IS" and with all faults, and the entire risk associated with such information is entirely with the user. All information contained herein is subject to change without notice. Customers should obtain and verify the latest relevant information before placing orders for RF-Lambda products. The information contained herein or any use of such information does not grant, explicitly or implicitly, to any party any patent rights, licenses, or any other intellectual property rights, whether with regard to such information itself or anything described by such information.

RF-Lambda products are not warranted or authorized for use as critical components in medical, life-saving, or life sustaining applications, or other applications where a failure would reasonably be expected to cause severe personal injury or death.