

SANYO

No.4794B

LC3564S, SS, SM, ST-70/85/10**64K (8192words × 8 bits)SRAM****Overview**

The LC3564S, LC3564SS, LC3564SM, and LC3564ST are asynchronous silicon gate CMOS static RAMs with an 8192-word X 8-bit organization. These SRAMs are full CMOS type SRAMs with a six-transistor memory cell and feature high-speed access, a low operating current, and an ultra-low standby current. Control signal inputs include an \overline{OE} input for high-speed memory access and two chip enable inputs, $\overline{CE1}$ and $\overline{CE2}$, for power-down and device selection. Thus these products are optimal for systems that require low power and/or battery backup and they support easy expansion of memory capacities. The ultra-low standby mode current drain allows capacitors to be used for backup and 3V operation makes these devices an excellent choice for use in battery operated portable equipment.

Features

- Supply voltage : 2.7 to 5.5V
 - 5V operation : $5.0V \pm 10\%$
 - 3V operation : $3.0V \pm 10\%$
- Address access time (t_{AA})
 - 5V operation
 - LC3564S, SS, SM, ST-70 : 70ns (max.)
 - LC3564S, SS, SM, ST-85 : 85ns (max.)
 - LC3564S, SS, SM, ST-10 : 100ns (max.)
 - 3V operation
 - LC3564S, SS, SM, SS-70 : 200ns (max.)
 - LC3564S, SS, SM, SS-85 : 250ns (max.)
 - LC3564S, SS, SM, SS-10 : 500ns (max.)
- Ultra-low standby current
 - 5V operation : $1.0\mu A$ ($T_a \leq 70^\circ C$)
 $3.0\mu A$ ($T_a \leq 85^\circ C$)
 - 3V operation : $0.8\mu A$ ($T_a \leq 70^\circ C$)
 $2.5\mu A$ ($T_a \leq 85^\circ C$)
- Operating temperature
 - 3V operation : $-40^\circ C$ to $+85^\circ C$
 - 5V operation : $-40^\circ C$ to $+85^\circ C$
- Data retention voltage : 2.0 to 5.5V
- All I/O levels
 - 5V operation : TTL compatible
 - 3V operation : $V_{CC} - 0.2V/0.2V$
- Three control inputs (\overline{OE} , $\overline{CE1}$, $\overline{CE2}$)
- Common input/output pins, three-state outputs
- No clock or timing signals required

• Package :

- 28-pin DIP (600mil)plastic package : LC3564S
- 28-pin DIP (300mil)plastic package : LC3564SS
- 28-pin SOP (450mil)plastic package : LC3564SM
- 28-pin TSOP (8 × 13.4mm)plastic package : LC3564ST

Package Dimensions

unit : mm

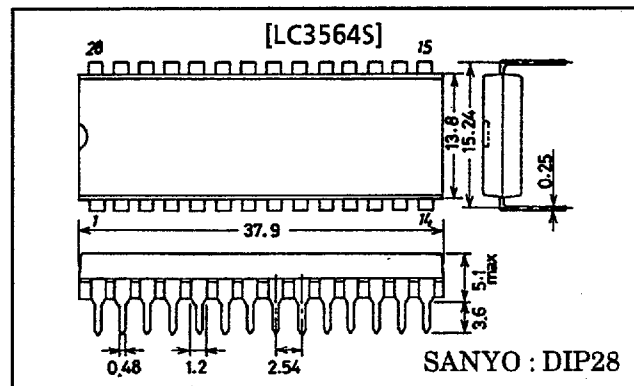
3012A-DIP28

unit : mm

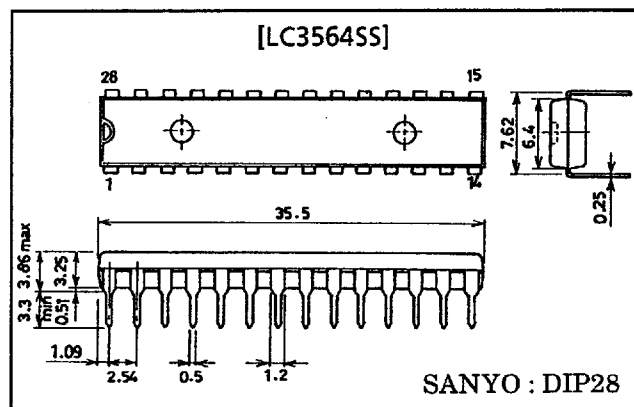
3133-DIP28**SANYO Electric Co., Ltd. Semiconductor Business Headquarters**

TOKYO OFFICE Tokyo Bldg., 1-10, 1 Chome, Ueno, Taito-ku, TOKYO, 110 JAPAN

7997076 0017121 9T5

51596HA (KT)/33195TH (KOTO)/20895TH (KOTO) No.4794-1/10

Pin Assignments

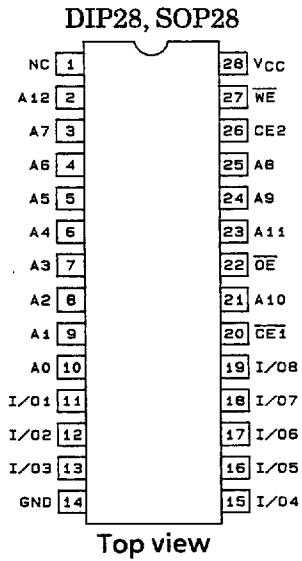

Package Dimensions

unit : mm
3187-SOP28

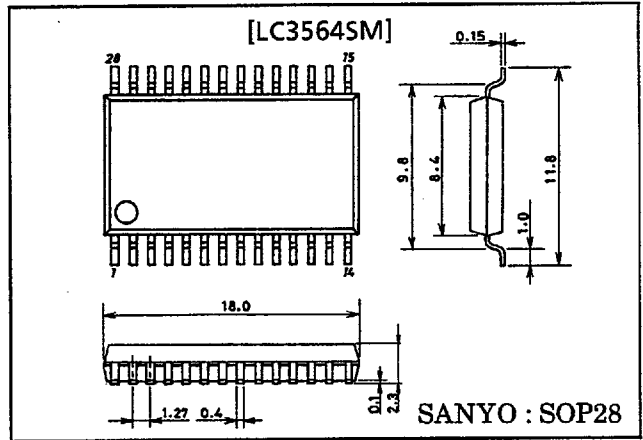

unit : mm
3221-TSOP28

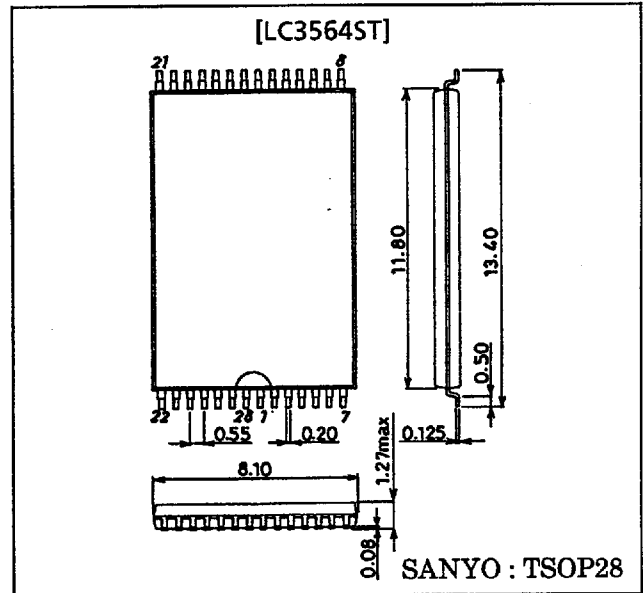
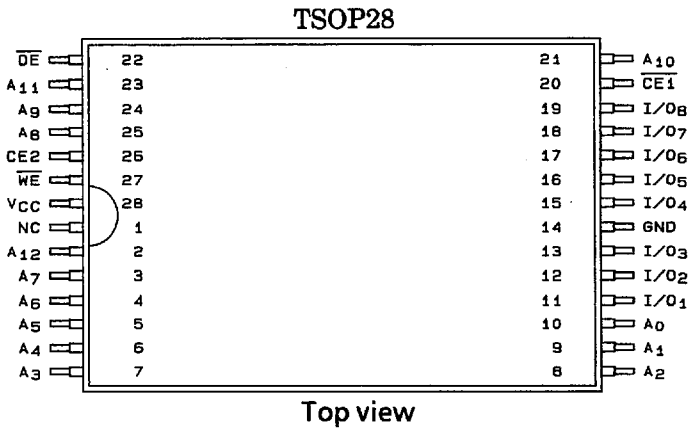

A0 to A12	Address input
\overline{WE}	Write enable
\overline{OE}	Output enable
$\overline{CE1}$, $\overline{CE2}$	Chip enable
I/O ₁ to I/O ₈	Data input/output
V _{CC} , GND	Power, ground

Block Diagram

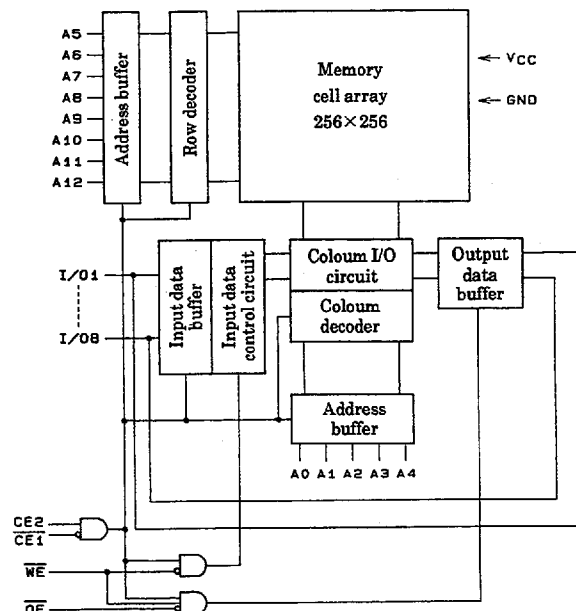

Pin Functions

Mode	$\overline{CE1}$	CE2	\overline{OE}	\overline{WE}	I/O	Current
Read Cycle	L	H	L	H	Data output	I_{CCA}
Write Cycle	L	H	×	L	Data input	I_{CCA}
Output Disable	L	H	H	H	High impedance	I_{CCA}
Unselected	H	×	×	×	High impedance	I_{CCS}
	×	L	×	×	High impedance	I_{CCS}

× : Arbitrary H or L

Specifications

Absolute Maximum Ratings at $T_a = 25^\circ\text{C}$

Parameter	Symbol	Conditions	Ratings	Unit
Max supply voltage	$V_{CC\ max}$		7.0	V
Input voltage	V_{IN}		-0.3* to $V_{CC} + 0.3$	V
I/O voltage	$V_{I/O}$		-0.3 to $V_{CC} + 0.3$	V
Operating temperature range	T_{opr}		-40 to +85	$^\circ\text{C}$
Storage temperature range	T_{stg}		-55 to +125	$^\circ\text{C}$

*) The inputs may undershoot to -3.0V (min.) for periods less than 30ns.

I/O Capacitance at $T_a = 25^\circ\text{C}$, $f = 1\text{MHz}$

Parameter	Symbol	Conditions	min	typ	max	Unit
Input/output capacitance	$C_{I/O}$	$V_{I/O} = 0\text{V}$		6	10	pF
Input capacitance	C_I	$V_{IN} = 0\text{V}$		6	10	pF

(Note) This parameter is sampled and not 100% tested.

5V Operation

DC Recommended Operating Ranges at $T_a = -40$ to $+85^\circ\text{C}$, $V_{CC} = 4.5$ to 5.5V

Parameter	Symbol	min	typ	max	Unit
Supply voltage	V_{CC}	4.5	5.0	5.5	V
Input voltage	V_{IH}	2.2		$V_{CC} + 0.3$	V
	V_{IL}	-0.3*		+0.8	V

*) The inputs may undershoot to -3.0V (min.) for periods less than 30ns.

DC Electrical Characteristics at $T_a = -40$ to $+85^\circ\text{C}$, $V_{CC} = 4.5$ to 5.5V

Parameter	Symbol	Conditions	min	typ*	max	Unit		
Input leakage current	I_{LI}	$V_{IN} = 0$ to V_{CC}	-1.0		+1.0	μA		
I/O leakage current	I_{LO}	$V_{CE1} = V_{IH}$ or $V_{CE2} = V_{IL}$ or $V_{OE} = V_{IH}$ or $V_{WE} = V_{IL}$, $V_{IO} = 0$ to V_{CC}	-1.0		+1.0	μA		
Output high level voltage	V_{OH}	$I_{OH} = -1.0\text{mA}$	2.4			V		
Output low level voltage	V_{OL}	$I_{OL} = 2.0\text{mA}$			0.4	V		
Operating current	$V_{CC} - 0.2\text{V}/0.2\text{V}$ input	I_{CCA1}	$V_{CE1} \leq 0.2\text{V}$, $V_{CE2} \geq V_{CC} - 0.2\text{V}$, $I_{IO} = 0\text{mA}$, $V_{IN} \leq 0.2\text{V}$ or $V_{IN} \geq V_{CC} - 0.2\text{V}$	$T_a \leq 70^\circ\text{C}$	0.01	1.0	μA	
				$T_a \leq 85^\circ\text{C}$		3.0		
	TTL input	I_{CCA4}	$V_{CE1} \leq 0.2\text{V}$, $V_{CE2} \geq V_{CC} - 0.2\text{V}$, $I_{IO} = 0\text{mA}$, DUTY 100%	min cycle	LC3564S, SS, SM, ST-70		35	mA
					LC3564S, SS, SM, ST-85		35	
					LC3564S, SS, SM, ST-10		30	
				$1\mu\text{s}$ cycle		4		
	TTL input	I_{CCA2}	$V_{CE1} = V_{IL}$, $V_{CE2} = V_{IH}$, $I_{IO} = 0\text{mA}$, $V_{IN} = V_{IH}$ or V_{IL}			7	mA	
				min cycle	LC3564S, SS, SM, SS-70			40
					LC3564S, SS, SM, SS-85			40
				$1\mu\text{s}$ cycle		7		
Standby current	$V_{CC} - 0.2\text{V}/0.2\text{V}$ input	I_{CCS1}	$V_{CE2} \leq 0.2\text{V}$ or $V_{CE1} \geq V_{CC} - 0.2\text{V}$ or $V_{CE2} \geq V_{CC} - 0.2\text{V}$	$T_a \leq 70^\circ\text{C}$	0.01	1.0	μA	
				$T_a \leq 85^\circ\text{C}$		3.0		
	TTL input	I_{CCS2}	$V_{CE2} = V_{IL}$ or $V_{CE1} = V_{IH}$, $V_{IN} = 0$ to V_{CC}			2.0	mA	

*) Reference value at $V_{CC} = 5\text{V}$, $T_a = 25^\circ\text{C}$

LC3564S, SS, SM, ST-70/85/10

AC Electrical Characteristics at Ta = -40 to +85°C, V_{CC} = 4.5 to 5.5V

AC test conditions

- Input pulse levels : V_{IH} = 2.4V, V_{IL} = 0.6V
- Input rise and fall time : 5ns
- Input and output timing reference levels : 1.5V
- Output load LC3564S, SS, SM, ST-70 : 30pF + 1TTL gate
(including jig capacitance)
- LC3564S, SS, SM, ST-85/10 : 100pF + 1TTL gate
(including jig capacitance)

Read Cycle

Parameter	Symbol	LC3564S, SS, SM, ST						Unit
		-70		-85		-10		
		min	max	min	max	min	max	
Read cycle time	t _{RC}	70		85		100		ns
Address access time	t _{AA}		70		85		100	ns
$\overline{CE1}$ access time	t _{CA1}		70		85		100	ns
CE2 access time	t _{CA2}		70		85		100	ns
\overline{OE} access time	t _{OA}		35		45		50	ns
Output hold time	t _{OH}	10		10		10		ns
$\overline{CE1}$ - output enable time	t _{COE1}	10		10		10		ns
CE2 - output enable time	t _{COE2}	10		10		10		ns
\overline{OE} - output enable time	t _{OOE}	5		5		5		ns
$\overline{CE1}$ - output disable time	t _{COD1}		30		35		35	ns
CE2 - output disable time	t _{COD2}		30		35		35	ns
\overline{OE} - output disable time	t _{OOD}		25		25		25	ns

Write Cycle

Parameter	Symbol	LC3564S, SS, SM, ST						Unit
		-70		-85		-10		
		min	max	min	max	min	max	
Write cycle time	t _{WC}	70		85		100		ns
Address setup time	t _{AS}	0		0		0		ns
Write pulse width	t _{WP}	50		55		55		ns
$\overline{CE1}$ setup time	t _{CW1}	60		65		65		ns
CE2 setup time	t _{CW2}	60		65		65		ns
Write recovery time	t _{WR}	0		0		0		ns
$\overline{CE1}$ write recovery time	t _{WR1}	0		0		0		ns
CE2 write recovery time	t _{WR2}	0		0		0		ns
Data setup time	t _{DS}	35		40		40		ns
Data hold time	t _{DH}	0		0		0		ns
$\overline{CE1}$ data hold time	t _{DH1}	0		0		0		ns
CE2 data hold time	t _{DH2}	0		0		0		ns
\overline{WE} - output enable time	t _{WOE}	5		5		5		ns
\overline{WE} - output disable time	t _{WOD}		30		35		35	ns

3V Operation

DC Recommended Operating Ranges at $T_a = -40$ to $+85^\circ\text{C}$, $V_{CC} = 2.7$ to 3.3V

Parameter	Symbol	min	typ	max	Unit
Supply voltage	V_{CC}	2.7	3.0	3.3	V
Input voltage	V_{IH}	$V_{CC} - 0.2$		V_{CC}	V
	V_{IL}	0		0.2	V

DC Electrical Characteristics at $T_a = -40$ to $+85^\circ\text{C}$, $V_{CC} = 2.7$ to 3.3V

Parameter		Symbol	Conditions	min	typ*	max	Unit		
Input leakage current		I_{LI}	$V_{IN} = 0$ to V_{CC}	-1.0		+1.0	μA		
I/O leakage current		I_{LO}	$V_{CE1} = V_{IH}$ or $V_{CE2} = V_{IL}$ or $V_{OE} = V_{IH}$ or $V_{WE} = V_{IL}$, $V_{IO} = 0$ to V_{CC}	-1.0		+1.0	μA		
Output high level voltage		V_{OH}	$I_{OH} = -0.5\text{mA}$	$V_{CC} - 0.2\text{V}$			V		
Output low level voltage		V_{OL}	$I_{OL} = 1.0\text{mA}$			0.2	V		
Operating current	$V_{CC} - 0.2\text{V}/$ 0.2V input	I_{CCA1}	$V_{CE1} \leq V_{IL}$, $V_{CE2} \geq V_{IH}$, $I_{IO} = 0\text{mA}$, $V_{IN} \leq V_{IL}$, $V_{IN} \geq V_{IH}$	$T_a \leq 70^\circ\text{C}$		0.01	0.8	μA	
				$T_a \leq 85^\circ\text{C}$			2.5		
		I_{CCA4}	$V_{CE1} \leq V_{IL}$, $V_{CE2} \geq V_{IH}$, $I_{IO} = 0\text{mA}$, DUTY = 100%	min cycle	LC3564S, SS, SM, ST-70			20	mA
					LC3564S, SS, SM, ST-85			20	
			LC3564S, SS, SM, ST-10			10			
				1 μs cycle		3	mA		
Standby current	$V_{CC} - 0.2\text{V}/$ 0.2V input	I_{CCS1}	$V_{CE2} \leq V_{IL}$ or $V_{CE1} \geq V_{IH}$ or $V_{CE2} \geq V_{IH}$	$T_a \leq 70^\circ\text{C}$		0.01	0.8	μA	
				$T_a \leq 85^\circ\text{C}$			2.5		

*) Reference value at $V_{CC} = 3\text{V}$, $T_a = 25^\circ\text{C}$

LC3564S, SS, SM, ST-70/85/10

AC Electrical Characteristics at $T_a = -40$ to $+85^\circ\text{C}$, $V_{CC} = 2.7$ to 3.3V

AC test conditions

Input pulse levels	:	$V_{IH} = V_{CC} - 0.2\text{V}$, $V_{IL} = 0.2\text{V}$
Input rise and fall time	:	10ns
Input and output timing reference levels	:	1.5V
Output load	LC3564S, SS, SM, ST-70	: 30pF (including scope and jig)
	LC3564S, SS, SM, ST-85/10	: 100pF (including scope and jig)

Read Cycle

Parameter	Symbol	LC3564S, SS, SM, ST						Unit
		-70		-85		-10		
		min	max	min	max	min	max	
Read cycle time	t_{RC}	200		250		500		ns
Address access time	t_{AA}		200		250		500	ns
$\overline{CE1}$ access time	t_{CA1}		200		250		500	ns
CE2 access time	t_{CA2}		200		250		500	ns
\overline{OE} access time	t_{OA}		100		130		250	ns
Output hold time	t_{OH}	20		20		20		ns
$\overline{CE1}$ - output enable time	t_{COE1}	20		20		20		ns
CE2 - output enable time	t_{COE2}	20		20		20		ns
\overline{OE} - output enable time	t_{OOE}	10		10		10		ns
$\overline{CE1}$ - output disable time	t_{COD1}		60		80		120	ns
CE2 - output disable time	t_{COD2}		60		80		120	ns
\overline{OE} - output disable time	t_{OOD}		50		70		100	ns

Write Cycle

Parameter	Symbol	LC3564S, SS, SM, ST						Unit
		-70		-85		-10		
		min	max	min	max	min	max	
Write cycle time	t_{WC}	200		250		500		ns
Address setup time	t_{AS}	0		0		0		ns
Write pulse width	t_{WP}	140		160		200		ns
$\overline{CE1}$ setup time	t_{CW1}	150		180		250		ns
CE2 setup time	t_{CW2}	150		180		250		ns
Write recovery time	t_{WR}	0		0		0		ns
$\overline{CE1}$ write recovery time	t_{WR1}	0		0		0		ns
CE2 write recovery time	t_{WR2}	0		0		0		ns
Data setup time	t_{DS}	130		150		180		ns
Data hold time	t_{DH}	0		0		0		ns
$\overline{CE1}$ data hold time	t_{DH1}	0		0		0		ns
CE2 data hold time	t_{DH2}	0		0		0		ns
\overline{WE} - output enable time	t_{WOE}	10		10		10		ns
\overline{WE} - output disable time	t_{WOD}		60		80		120	ns

Timing Waveform

Read Cycle Note (1)

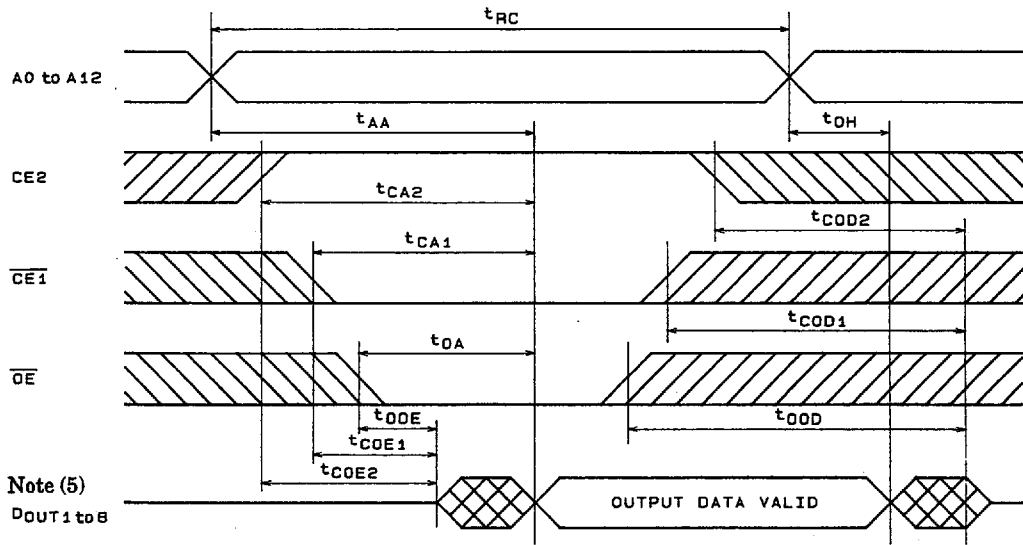

Write Cycle 1 (\overline{WE} Write) Note (6)

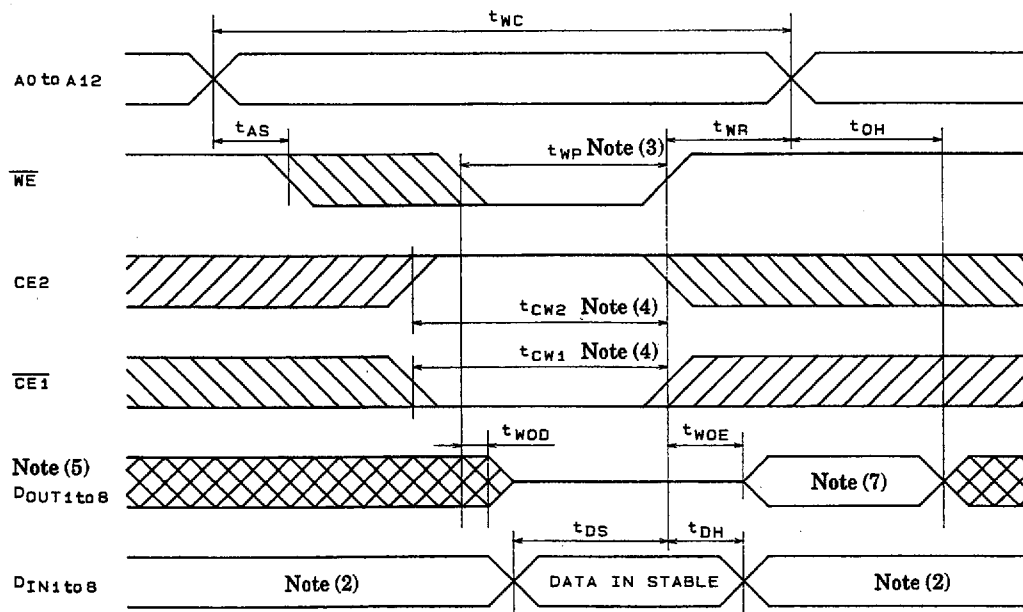

Write Cycle 2 ($\overline{CE1}$ Write) Note (6)

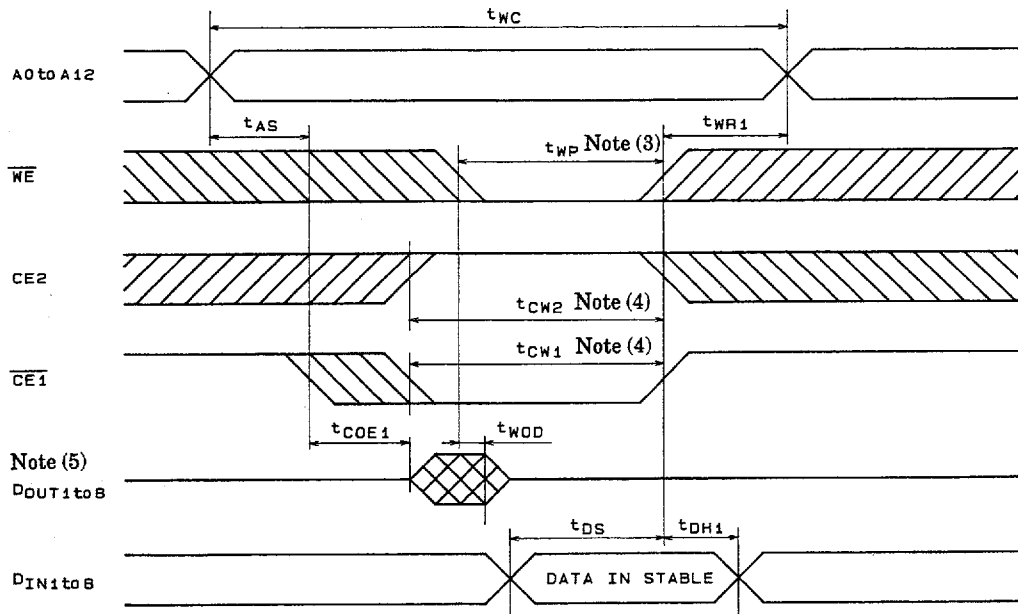

Write Cycle 3 (CE2 Write) Note (6)

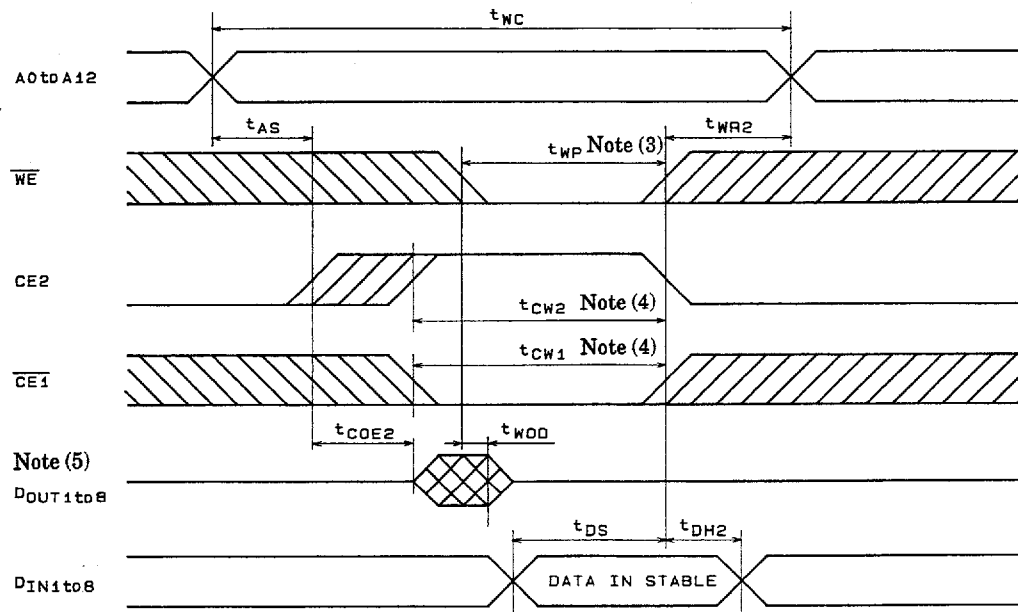

Notes : (1) In Read Cycle, \overline{WE} should be high.

(2) During this period, I/O pins are in the output state, therefore the input signals of opposite phase to the outputs must not be applied.

(3) A write occurs during the overlap of a low $\overline{CE1}$, a high CE2 and a low \overline{WE} .

A write begins at the latest transition among $\overline{CE1}$ going low, CE2 going high and \overline{WE} going low.

A write ends at the earliest transition among $\overline{CE1}$ going high, CE2 going low and \overline{WE} going high.

t_{WP} is measured from the beginning of write to the end of write.

(4) t_{CW1} , t_{CW2} are measured from the later of $\overline{CE1}$ going low or CE2 going high to the end of write.

(5) If one of these conditions (\overline{OE} is high, $\overline{CE1}$ is high, CE2 is low, \overline{WE} is low) at least is satisfied, D_{OUT} goes to high impedance state.

(6) In Write Cycle, $\overline{OE} = V_{IH}$ or V_{IL} .

(7) D_{OUT} is in the same phase of written data of this cycle.

Data Retention Characteristics at $T_a = -40$ to $+85^\circ\text{C}$

Parameter	Symbol	Conditions	min	typ	max	Unit
Date retention supply voltage	V_{DR}	$V_{CE2} \leq 0.2\text{V}$, or $V_{CE1} \geq V_{CC} - 0.2\text{V}$ or $V_{CE2} \geq V_{CC} - 0.2\text{V}$	2.0		5.5	V
Data retention current	I_{CCDR}	$V_{CC} = 3\text{V}$, $V_{CE2} \leq 0.2\text{V}$, or $V_{CE1} \geq V_{CC} - 0.2\text{V}$ or $V_{CE2} \geq V_{CC} - 0.2\text{V}$			0.8	μA
					2.5	
Chip enable setup time	t_{CDR}		0			ns
Chip enable hold time	t_R		t_{RC}^*			ns

*) t_{RC} = Read Cycle Time

Data Retention Waveform (1) ($\overline{CE1}$ CONTROL)

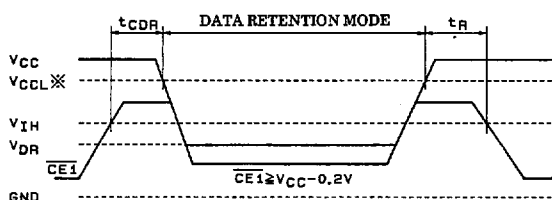

Data Retention Waveform (2) (CE2 CONTROL)

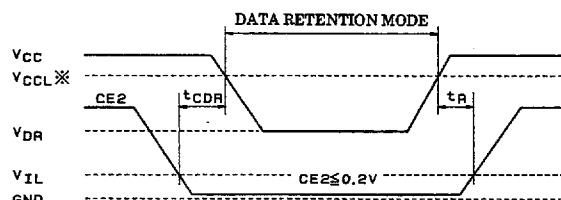

*) V_{CCCL} — 5V operation : 4.5V
3V operation : 2.7V

■ No products described or contained herein are intended for use in surgical implants, life-support systems, aerospace equipment, nuclear power control systems, vehicles, disaster/crime-prevention equipment and the like, the failure of which may directly or indirectly cause injury, death or property loss.

■ Anyone purchasing any products described or contained herein for an above-mentioned use shall:

- ① Accept full responsibility and indemnify and defend SANYO ELECTRIC CO., LTD., its affiliates, subsidiaries and distributors and all their officers and employees, jointly and severally, against any and all claims and litigation and all damages, cost and expenses associated with such use:
- ② Not impose any responsibility for any fault or negligence which may be cited in any such claim or litigation on SANYO ELECTRIC CO., LTD., its affiliates, subsidiaries and distributors or any of their officers and employees jointly or severally.

■ Information (including circuit diagrams and circuit parameters) herein is for example only; it is not guaranteed for volume production. SANYO believes information herein is accurate and reliable, but no guarantees are made or implied regarding its use or any infringements of intellectual property rights or other rights of third parties.

This catalog provides information as of May, 1996. Specifications and information herein are subject to change without notice.