

# Three Level NPC Q2Pack Module

## NXH350N100H4Q2F2P1G, NXH350N100H4Q2F2S1G, NXH350N100H4Q2F2S1G-R

This high-density, integrated power module combines high-performance IGBTs with rugged anti-parallel diodes.

### Features

- Extremely Efficient Trench with Field Stop Technology
- Low Switching Loss Reduces System Power Dissipation
- Module Design Offers High Power Density
- Low Inductive Layout
- Low Package Height
- These Devices are Pb-Free, Halogen Free/BFR Free and are RoHS Compliant

### Typical Applications

- Solar Inverters
- Uninterruptable Power Supplies Systems

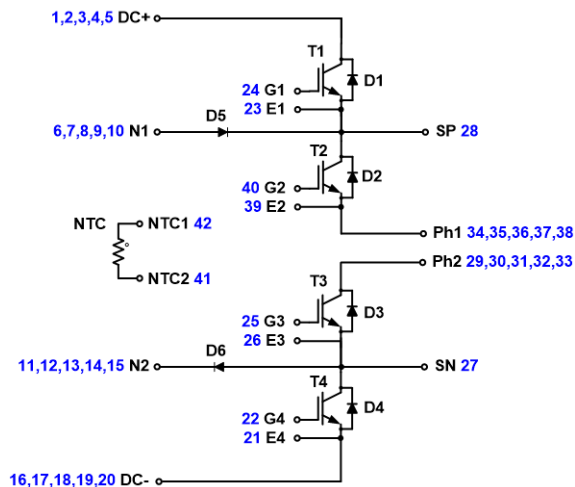
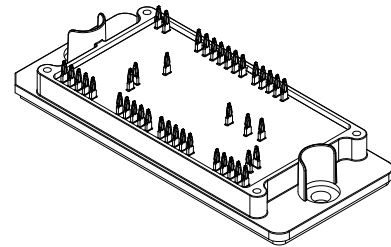
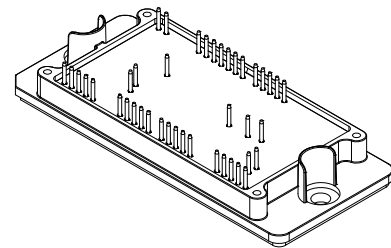

Figure 1. NXH350N100H4Q2F2P1G/S1G/SG-R Schematic Diagram

### PACKAGE PICTURE



Q2PACK INPC PRESS FIT PINS  
CASE 180BH



Q2PACK INPC SOLDER PINS  
CASE 180BS

### MARKING DIAGRAM

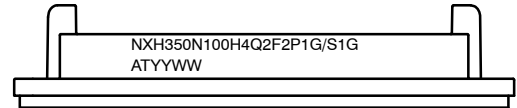

G = Pb-Free Package  
AT = Assembly & Test Site Code  
YYWW = Year and Work Week Code

### PIN CONNECTIONS

See details pin connections on page 2 of this data sheet.

### ORDERING INFORMATION

See detailed ordering and shipping information on page 5 of this data sheet.

PIN CONNECTIONS

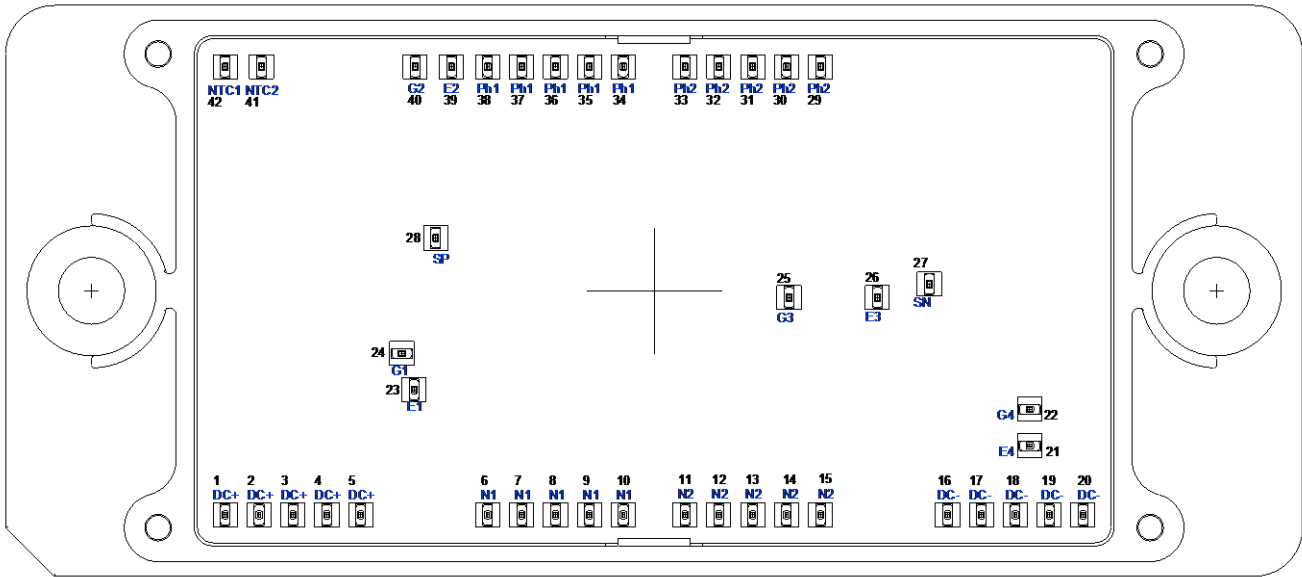

Figure 2. Pin Connections

**ABSOLUTE MAXIMUM RATINGS** ( $T_J = 25^\circ\text{C}$  unless otherwise noted)

Rating	Symbol	Value	Unit
<b>OUTER IGBT (T1, T4)</b>			
Collector-Emitter Voltage	$V_{CES}$	1000	V
Gate-Emitter Voltage	$V_{GE}$	$\pm 20$	V
Positive Transient Gate-Emitter Voltage ( $T_{pulse} = 5 \mu\text{s}$ , $D < 0.10$ )		30	
Continuous Collector Current @ $T_C = 80^\circ\text{C}$	$I_C$	303	A
Pulsed Peak Collector Current @ $T_C = 80^\circ\text{C}$ ( $T_J = 150^\circ\text{C}$ )	$I_{C(Pulse)}$	909	A
Maximum Power Dissipation ( $T_J = 150^\circ\text{C}$ )	$P_{tot}$	592	W
Minimum Operating Junction Temperature	$T_{JMIN}$	-40	$^\circ\text{C}$
Maximum Operating Junction Temperature	$T_{JMAX}$	175	$^\circ\text{C}$
<b>INNER IGBT (T2, T3)</b>			
Collector-Emitter Voltage	$V_{CES}$	1000	V
Gate-Emitter Voltage	$V_{GE}$	$\pm 20$	V
Positive Transient Gate-Emitter Voltage ( $T_{pulse} = 5 \mu\text{s}$ , $D < 0.10$ )		30	
Continuous Collector Current @ $T_C = 80^\circ\text{C}$	$I_C$	298	A
Pulsed Peak Collector Current @ $T_C = 80^\circ\text{C}$ ( $T_J = 150^\circ\text{C}$ )	$I_{C(Pulse)}$	894	A
Maximum Power Dissipation ( $T_J = 175^\circ\text{C}$ )	$P_{tot}$	731	W
Minimum Operating Junction Temperature	$T_{JMIN}$	-40	$^\circ\text{C}$
Maximum Operating Junction Temperature	$T_{JMAX}$	175	$^\circ\text{C}$
<b>IGBT INVERSE DIODE (D1, D2, D3, D4)</b>			
Peak Repetitive Reverse Voltage	$V_{RRM}$	1000	V
Continuous Forward Current @ $T_C = 80^\circ\text{C}$	$I_F$	133	A
Repetitive Peak Forward Current ( $T_J = 175^\circ\text{C}$ )	$I_{FRM}$	399	A
Maximum Power Dissipation ( $T_J = 175^\circ\text{C}$ )	$P_{tot}$	276	W

# NXH350N100H4Q2F2P1G, NXH350N100H4Q2F2S1G, NXH350N100H4Q2F2S1G-R

## ABSOLUTE MAXIMUM RATINGS ( $T_J = 25^\circ\text{C}$ unless otherwise noted) (continued)

Rating	Symbol	Value	Unit
--------	--------	-------	------

### IGBT INVERSE DIODE (D1, D2, D3, D4)

Minimum Operating Junction Temperature	$T_{JMIN}$	-40	$^\circ\text{C}$
Maximum Operating Junction Temperature	$T_{JMAX}$	175	$^\circ\text{C}$

### NEUTRAL POINT DIODE (D5, D6)

Peak Repetitive Reverse Voltage	$V_{RRM}$	1200	V
Continuous Forward Current @ $T_C = 80^\circ\text{C}$	$I_F$	98	A
Repetitive Peak Forward Current ( $T_J = 175^\circ\text{C}$ )	$I_{FRM}$	294	A
Maximum Power Dissipation ( $T_J = 175^\circ\text{C}$ )	$P_{tot}$	239	W
Minimum Operating Junction Temperature	$T_{JMIN}$	-40	$^\circ\text{C}$
Maximum Operating Junction Temperature	$T_{JMAX}$	175	$^\circ\text{C}$

### THERMAL PROPERTIES

Operating Temperature under Switching Condition	$T_{VJOP}$	-40 to +150	$^\circ\text{C}$
Storage Temperature Range	$T_{stg}$	-40 to +125	$^\circ\text{C}$

### INSULATION PROPERTIES

Isolation Test Voltage, $t = 1$ s, 50 Hz (Note 2)	$V_{is}$	4000	$V_{RMS}$
Creepage Distance		12.7	mm
Comparative Tracking Index	CTI	> 600	

Stresses exceeding those listed in the Maximum Ratings table may damage the device. If any of these limits are exceeded, device functionality should not be assumed, damage may occur and reliability may be affected.

1. Refer to [ELECTRICAL CHARACTERISTICS](#) and/or APPLICATION INFORMATION for Safe Operating parameters.
2. 4000 VAC<sub>RMS</sub> for 1 second duration is equivalent to 3333 VAC<sub>RMS</sub> for 1 minute duration.

## ELECTRICAL CHARACTERISTICS ( $T_J = 25^\circ\text{C}$ unless otherwise specified)

Characteristic	Test Conditions	Symbol	Min	Typ	Max	Unit
----------------	-----------------	--------	-----	-----	-----	------

### OUTER IGBT (T1, T4) CHARACTERISTICS

Collector-Emitter Cutoff Current	$V_{GE} = 0$ V, $V_{CE} = 1000$ V	$I_{CES}$	-	-	1000	$\mu\text{A}$	
Collector-Emitter Saturation Voltage	$V_{GE} = 15$ V, $I_C = 375$ A, $T_J = 25^\circ\text{C}$	$V_{CE(sat)}$	-	1.63	2.3	V	
	$V_{GE} = 15$ V, $I_C = 375$ A, $T_J = 150^\circ\text{C}$		-	1.92	-		
Gate-Emitter Threshold Voltage	$V_{GE} = V_{CE}$ , $I_C = 375$ mA	$V_{GE(TH)}$	3.8	4.84	6.1	V	
Gate Leakage Current	$V_{GE} = \pm 20$ V, $V_{CE} = 0$ V	$I_{GES}$	-	-	$\pm 2000$	nA	
Turn-on Delay Time	$T_J = 25^\circ\text{C}$ $V_{CE} = 600$ V, $I_C = 150$ A $V_{GE} = -9$ V, 15 V, $R_G = 6$ $\Omega$	$t_{d(on)}$	-	85	-	ns	
Rise Time		$t_r$	-	27	-		
Turn-off Delay Time		$t_{d(off)}$	-	319	-		
Fall Time		$t_f$	-	52	-		
Turn-on Switching Loss per Pulse		$E_{on}$	-	2.5	-		mJ
Turn-off Switching Loss per Pulse		$E_{off}$	-	4.9	-		
Turn-on Delay Time		$T_J = 125^\circ\text{C}$ $V_{CE} = 600$ V, $I_C = 150$ A $V_{GE} = -9$ V, 15 V, $R_G = 6$ $\Omega$	$t_{d(on)}$	-	80		-
Rise Time	$t_r$		-	31	-		
Turn-off Delay Time	$t_{d(off)}$		-	355	-		
Fall Time	$t_f$		-	70	-		
Turn-on Switching Loss per Pulse	$E_{on}$		-	3.1	-	mJ	
Turn-off Switching Loss per Pulse	$E_{off}$		-	7.3	-		

# NXH350N100H4Q2F2P1G, NXH350N100H4Q2F2S1G, NXH350N100H4Q2F2S1G-R

## ELECTRICAL CHARACTERISTICS (T<sub>J</sub> = 25°C unless otherwise specified) (continued)

Characteristic	Test Conditions	Symbol	Min	Typ	Max	Unit	
<b>OUTER IGBT (T1, T4) CHARACTERISTICS</b>							
Input Capacitance	V <sub>CE</sub> = 20 V, V <sub>GE</sub> = 0 V, f = 1 MHz	C <sub>ies</sub>	–	24146	–	pF	
Output Capacitance		C <sub>oes</sub>	–	1027	–		
Reverse Transfer Capacitance		C <sub>res</sub>	–	106	–		
Total Gate Charge	V <sub>CE</sub> = 600 V, I <sub>C</sub> = 375 A, V <sub>GE</sub> = -15 V~15 V	Q <sub>g</sub>	–	1249	–	nC	
Thermal Resistance – Chip-to-Heatsink	Thermal grease, Thickness = 2.1 Mil ±2% λ = 2.9 W/mK	R <sub>thJH</sub>	–	0.22	–	K/W	
Thermal Resistance – Chip-to-Case		R <sub>thJC</sub>	–	0.12	–	K/W	
<b>NEUTRAL POINT DIODE (D5, D6) CHARACTERISTICS</b>							
Diode Forward Voltage	I <sub>F</sub> = 100 A, T <sub>J</sub> = 25°C	V <sub>F</sub>	–	1.50	1.85	V	
	I <sub>F</sub> = 100 A, T <sub>J</sub> = 150°C		–	2.07	–		
Reverse Recovery Time	T <sub>J</sub> = 25°C V <sub>CE</sub> = 600 V, I <sub>C</sub> = 150 A V <sub>GE</sub> = -8 V, 15 V, R <sub>G</sub> = 6 Ω	t <sub>rr</sub>	–	19	–	ns	
Reverse Recovery Charge		Q <sub>rr</sub>	–	229	–	nC	
Peak Reverse Recovery Current		I <sub>RRM</sub>	–	19	–	A	
Reverse Recovery Energy		E <sub>rr</sub>	–	164	–	μJ	
Reverse Recovery Time	T <sub>J</sub> = 125°C V <sub>CE</sub> = 600 V, I <sub>C</sub> = 150 A V <sub>GE</sub> = -8 V, 15 V, R <sub>G</sub> = 6 Ω	t <sub>rr</sub>	–	34	–	ns	
Reverse Recovery Charge		Q <sub>rr</sub>	–	359	–	nC	
Peak Reverse Recovery Current		I <sub>RRM</sub>	–	17	–	A	
Reverse Recovery Energy		E <sub>rr</sub>	–	211	–	μJ	
Thermal Resistance – Chip-to-Heatsink	Thermal grease, Thickness = 2.1 Mil ±2% λ = 2.9 W/mK	R <sub>thJH</sub>	–	0.42	–	K/W	
Thermal Resistance – Chip-to-Case		R <sub>thJC</sub>	–	0.29	–	K/W	
<b>INNER IGBT (T2, T3) CHARACTERISTICS</b>							
Collector-Emitter Cutoff Current	V <sub>GE</sub> = 0 V, V <sub>CE</sub> = 1000 V	I <sub>CES</sub>	–	–	500	μA	
Collector-Emitter Saturation Voltage	V <sub>GE</sub> = 15 V, I <sub>C</sub> = 400 A, T <sub>J</sub> = 25°C	V <sub>CE(sat)</sub>	–	1.75	2.3	V	
	V <sub>GE</sub> = 15 V, I <sub>C</sub> = 400 A, T <sub>J</sub> = 150°C		–	2.11	–		
Gate-Emitter Threshold Voltage	V <sub>GE</sub> = V <sub>CE</sub> , I <sub>C</sub> = 400 mA	V <sub>GE(TH)</sub>	4.1	5	6.1	V	
Gate Leakage Current	V <sub>GE</sub> = ±20 V, V <sub>CE</sub> = 0 V	I <sub>GES</sub>	–	–	±2000	nA	
Turn-on Delay Time	T <sub>J</sub> = 25°C V <sub>CE</sub> = 600 V, I <sub>C</sub> = 150 A V <sub>GE</sub> = -9 V, 15 V, R <sub>G</sub> = 11 Ω	t <sub>d(on)</sub>	–	70	–	ns	
Rise Time		t <sub>r</sub>	–	31	–		
Turn-off Delay Time		t <sub>d(off)</sub>	–	423	–		
Fall Time		t <sub>f</sub>	–	74	–		
Turn-on Switching Loss per Pulse		E <sub>on</sub>	–	6.4	–		mJ
Turn-off Switching Loss per Pulse		E <sub>off</sub>	–	4.2	–		
Turn-on Delay Time	T <sub>J</sub> = 125°C V <sub>CE</sub> = 600 V, I <sub>C</sub> = 150 A V <sub>GE</sub> = -9 V, 15 V, R <sub>G</sub> = 11 Ω	t <sub>d(on)</sub>	–	66	–	ns	
Rise Time		t <sub>r</sub>	–	31	–		
Turn-off Delay Time		t <sub>d(off)</sub>	–	509	–		
Fall Time		t <sub>f</sub>	–	88	–		
Turn-on Switching Loss per Pulse		E <sub>on</sub>	–	9.7	–		mJ
Turn-off Switching Loss per Pulse		E <sub>off</sub>	–	8.2	–		
Input Capacitance	V <sub>CE</sub> = 20 V, V <sub>GE</sub> = 0 V, f = 1 MHz	C <sub>ies</sub>	–	26093	–	pF	
Output Capacitance		C <sub>oes</sub>	–	1012	–		
Reverse Transfer Capacitance		C <sub>res</sub>	–	104	–		

# NXH350N100H4Q2F2P1G, NXH350N100H4Q2F2S1G, NXH350N100H4Q2F2S1G-R

## ELECTRICAL CHARACTERISTICS ( $T_J = 25^\circ\text{C}$ unless otherwise specified) (continued)

Characteristic	Test Conditions	Symbol	Min	Typ	Max	Unit
<b>INNER IGBT (T2, T3) CHARACTERISTICS</b>						
Internal Gage Resistor		$R_{gint}$	–	1.25	–	$\Omega$
Total Gate Charge	$V_{CE} = 600\text{ V}$ , $I_C = 400\text{ A}$ , $V_{GE} = -15\text{ V} \sim 15\text{ V}$	$Q_g$	–	1304	–	nC
Thermal Resistance – Chip-to-Heatsink	Thermal grease, Thickness = 2.1 Mil $\pm 2\%$ $\lambda = 2.9\text{ W/mK}$	$R_{thJH}$	–	0.24	–	K/W
Thermal Resistance – Chip-to-Case		$R_{thJC}$	–	0.13	–	K/W

## IGBT INVERSE DIODE (D1, D2, D3, D4) CHARACTERISTICS

Diode Forward Voltage	$I_F = 150\text{ A}$ , $T_J = 25^\circ\text{C}$	$V_F$	–	2.06	2.6	V
	$I_F = 150\text{ A}$ , $T_J = 150^\circ\text{C}$		–	1.77	–	
Reverse Recovery Time	$T_J = 25^\circ\text{C}$ $V_{CE} = 600\text{ V}$ , $I_C = 150\text{ A}$ $V_{GE} = -8\text{ V}$ , $15\text{ V}$ , $R_G = 6\ \Omega$	$t_{rr}$	–	105	–	ns
Reverse Recovery Charge		$Q_{rr}$	–	4179	–	nC
Peak Reverse Recovery Current		$I_{RRM}$	–	97	–	A
Reverse Recovery Energy		$E_{rr}$	–	4665	–	$\mu\text{J}$
Reverse Recovery Time	$T_J = 125^\circ\text{C}$ $V_{CE} = 600\text{ V}$ , $I_C = 150\text{ A}$ $V_{GE} = -8\text{ V}$ , $15\text{ V}$ , $R_G = 6\ \Omega$	$t_{rr}$	–	179	–	ns
Reverse Recovery Charge		$Q_{rr}$	–	11900	–	nC
Peak Reverse Recovery Current		$I_{RRM}$	–	133	–	A
Reverse Recovery Energy		$E_{rr}$	–	3783	–	$\mu\text{J}$
Thermal Resistance – Chip-to-Heatsink	Thermal grease, Thickness = 2.1 Mil $\pm 2\%$ $\lambda = 2.9\text{ W/mK}$	$R_{thJH}$	–	0.39	–	K/W
Thermal Resistance – Chip-to-Case		$R_{thJC}$	–	0.25	–	K/W

## THERMISTOR CHARACTERISTICS

Nominal Resistance	$T = 25^\circ\text{C}$	$R_{25}$	–	22	–	k $\Omega$
Nominal Resistance	$T = 100^\circ\text{C}$	$R_{100}$	–	1486	–	k $\Omega$
Deviation of R25		$\Delta R/R$	-5	–	5	%
Power Dissipation		$P_D$	–	200	–	mW
Power Dissipation Constant			–	2	–	mW/K
B-value	B(25/50), tolerance $\pm 3\%$		–	3950	–	K
B-value	B(25/100), tolerance $\pm 3\%$		–	3998	–	K

Product parametric performance is indicated in the Electrical Characteristics for the listed test conditions, unless otherwise noted. Product performance may not be indicated by the Electrical Characteristics if operated under different conditions.

## ORDERING INFORMATION

Part Number	Marking	Package	Shipping
NXH350N100H4Q2F2P1G PRESS FIT PINS	NXH350N100H4Q2F2P1G	Q2PACK (Pb-Free/Halide-Free)	12 Units / Blister Tray
NXH350N100H4Q2F2S1G, NXH350N100H4Q2F2S1G-R SOLDER PINS	NXH350N100H4Q2F2S1G, NXH350N100H4Q2F2S1G-R	Q2PACK (Pb-Free/Halide-Free)	12 Units / Blister Tray

TYPICAL CHARACTERISTICS – OUTER IGBT

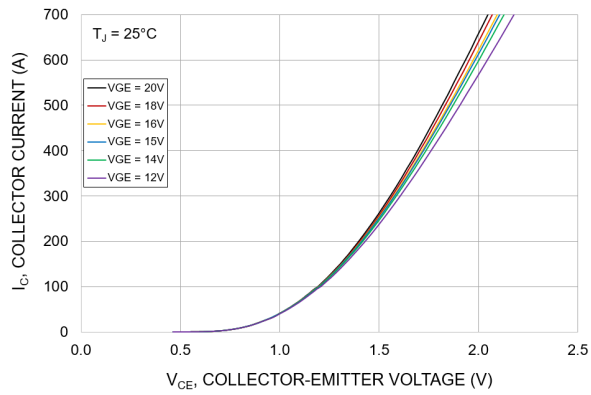

Figure 3. Typical Output Characteristics – Outer IGBT

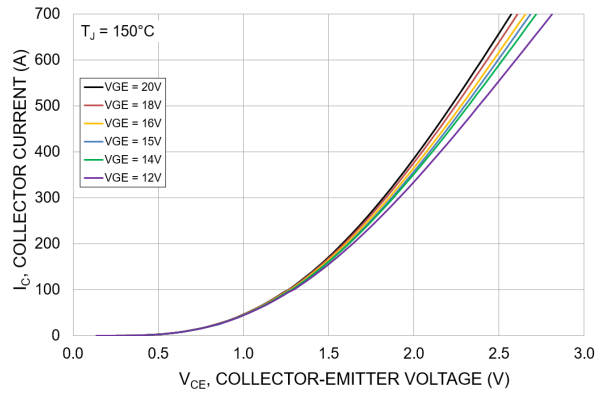

Figure 4. Typical Output Characteristics – Outer IGBT

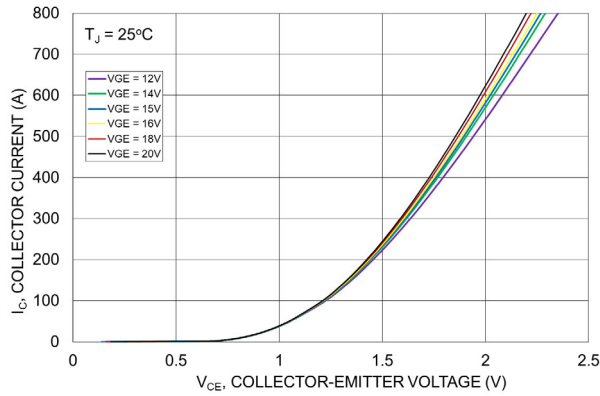

Figure 5. Typical Output Characteristics – Inner IGBT

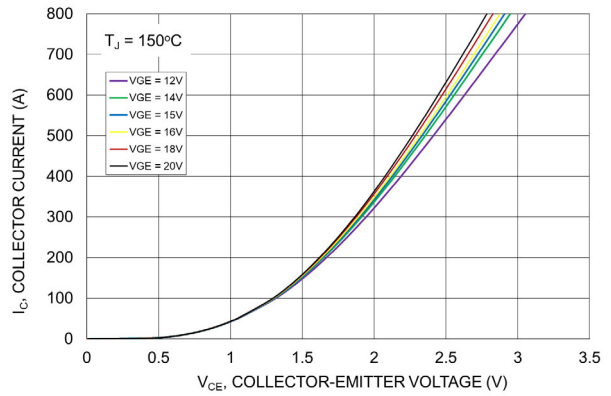

Figure 6. Typical Output Characteristics – Inner IGBT

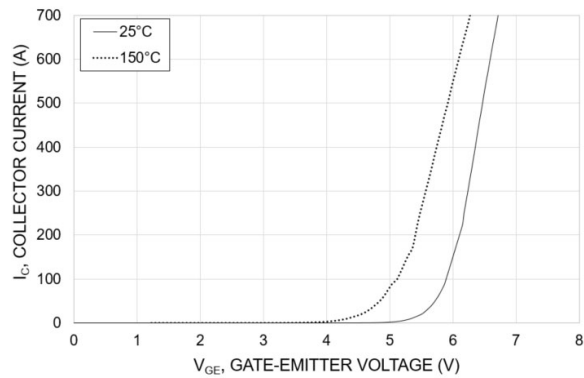

Figure 7. Transfer Characteristics – Outer IGBT

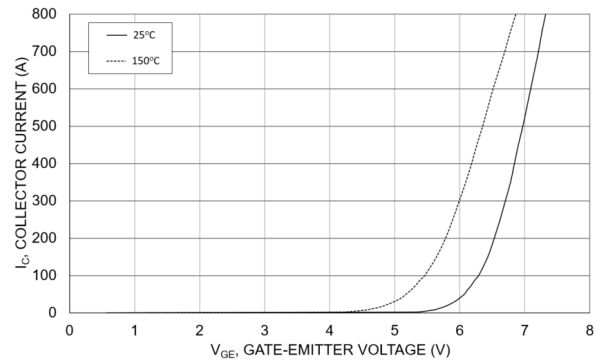

Figure 8. Transfer Characteristics – Inner IGBT

TYPICAL CHARACTERISTICS – OUTER IGBT, INNER IGBT, IGBT INVERSE DIODE AND NEUTRAL POINT DIODE

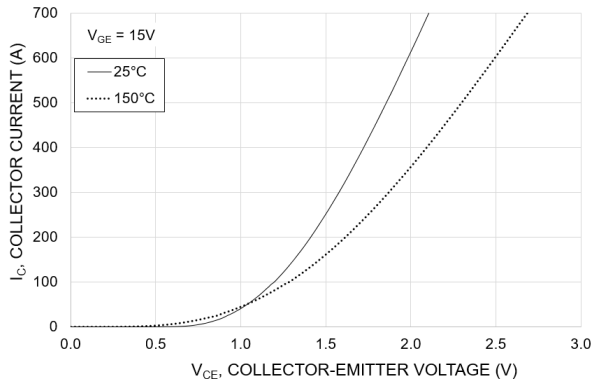

Figure 9. Typical Saturation Voltage Characteristics – Outer IGBT

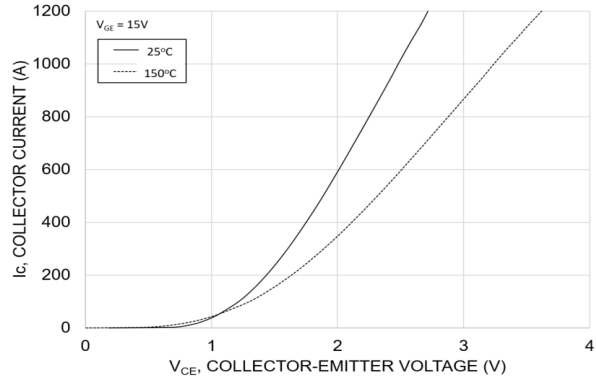

Figure 10. Typical Saturation Voltage Characteristics – Inner IGBT

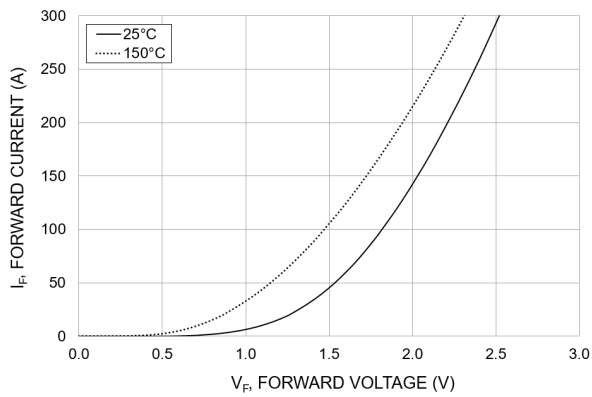

Figure 11. Inverse Diode Forward Characteristics

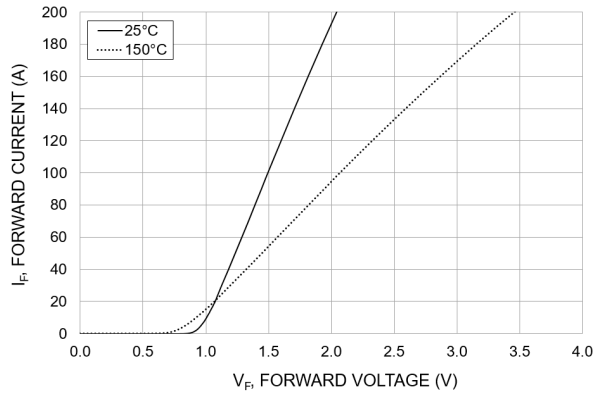

Figure 12. Buck Diode Forward Characteristics

TYPICAL SWITCHING CHARACTERISTICS – OUTER IGBT

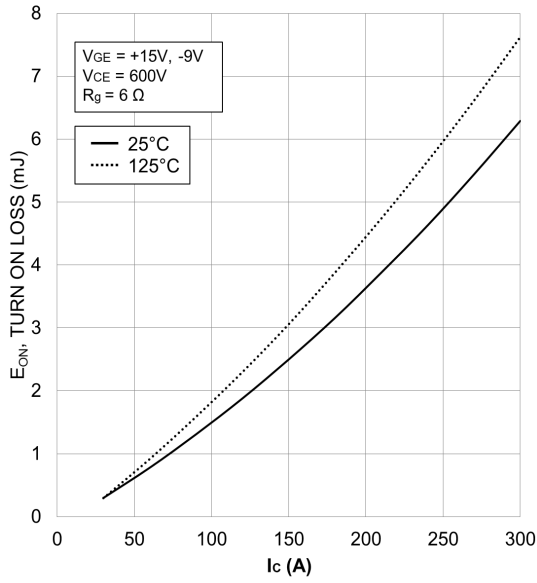

Figure 13. Typical Turn On Loss vs.  $I_C$

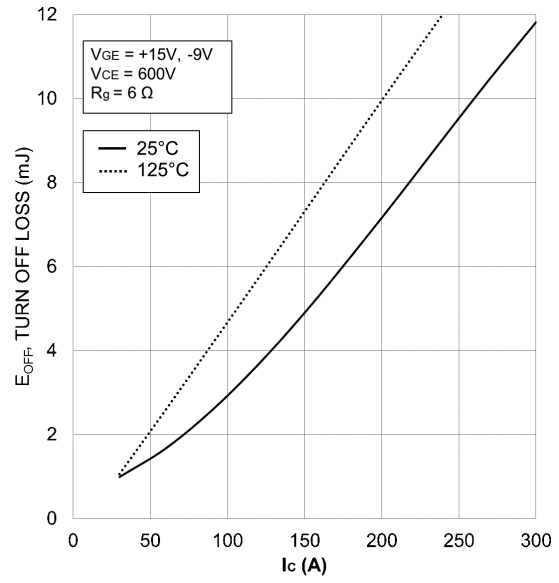

Figure 14. Typical Turn Off Loss vs.  $I_C$

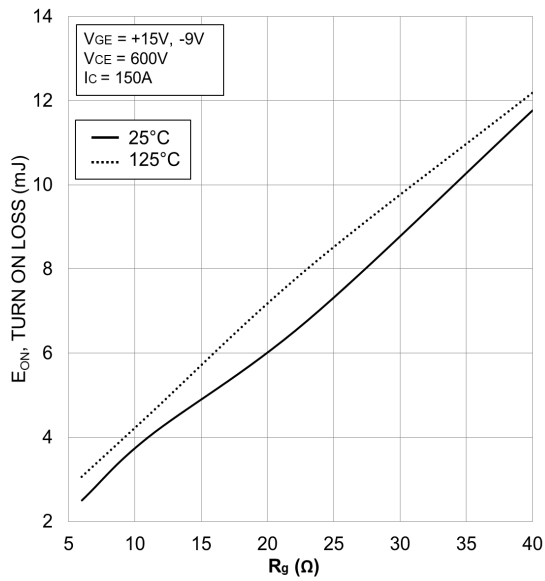

Figure 15. Typical Turn On Loss vs.  $R_G$

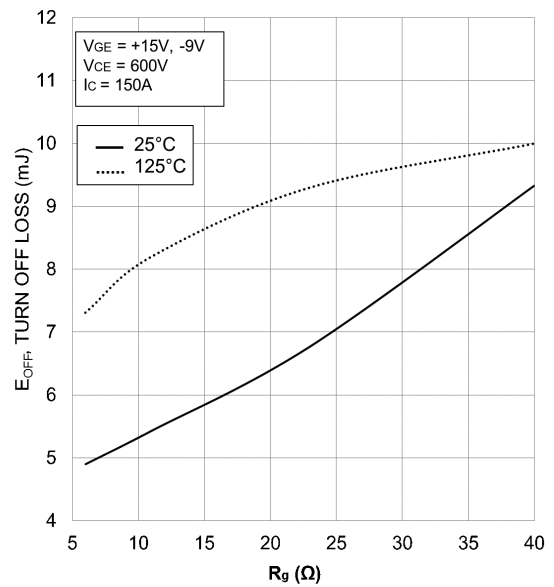

Figure 16. Typical Turn Off Loss vs.  $R_G$

TYPICAL SWITCHING CHARACTERISTICS – OUTER IGBT (Continued)

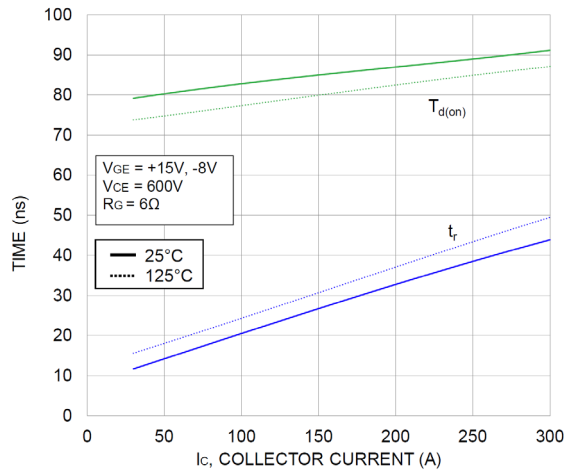

Figure 17. Typical Turn On Switching Time vs.  $I_C$

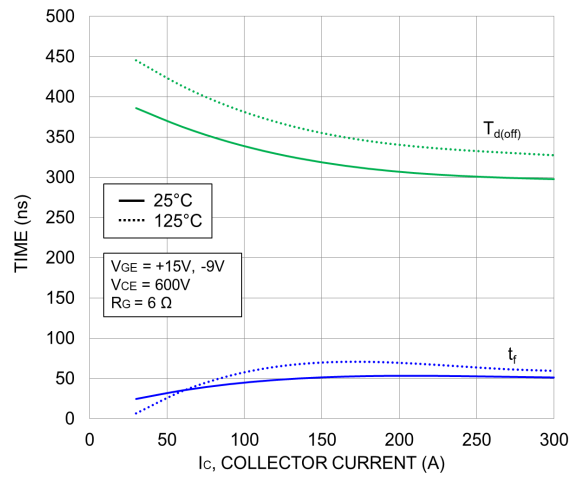

Figure 18. Typical Turn Off Switching Time vs.  $I_C$

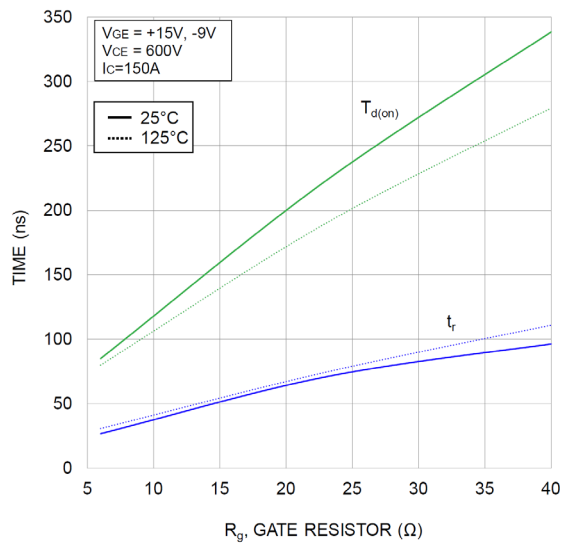

Figure 19. Typical Turn On Switching Time vs.  $R_G$

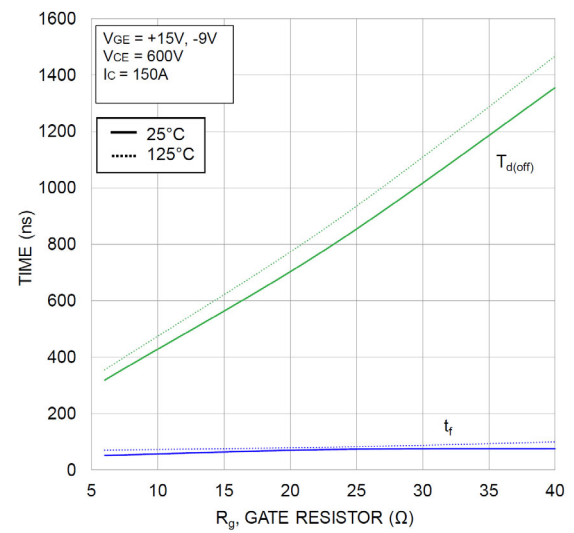

Figure 20. Typical Turn Off Switching Time vs.  $R_G$

TYPICAL SWITCHING CHARACTERISTICS – INNER IGBT

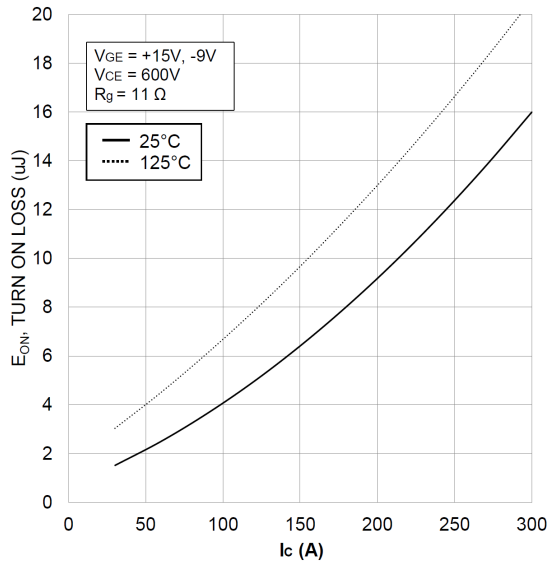

Figure 21. Typical Turn On Loss vs.  $I_c$

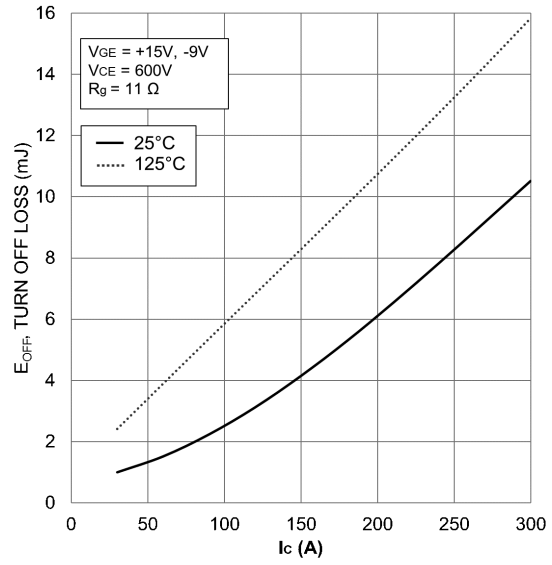

Figure 22. Typical Turn Off Loss vs.  $I_c$

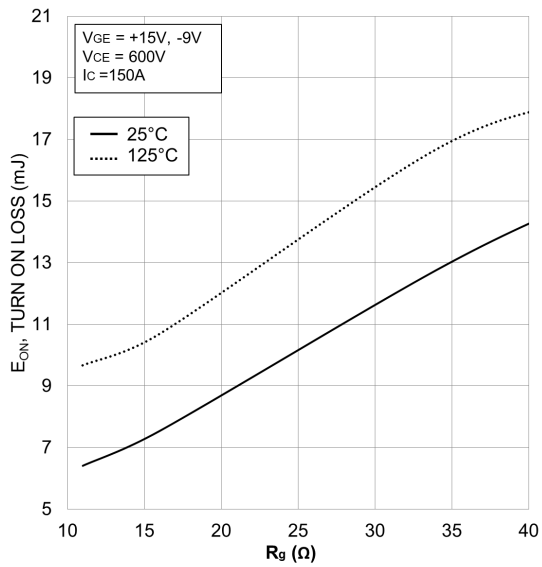

Figure 23. Typical Turn On Loss vs.  $R_g$

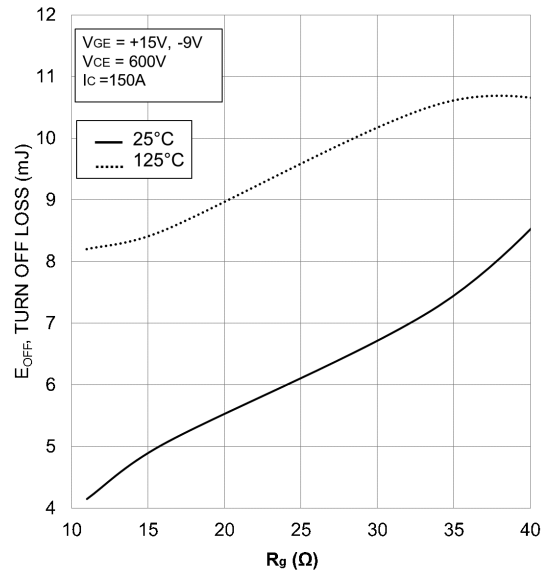

Figure 24. Typical Turn Off Loss vs.  $R_g$

TYPICAL SWITCHING CHARACTERISTICS – INNER IGBT (Continued)

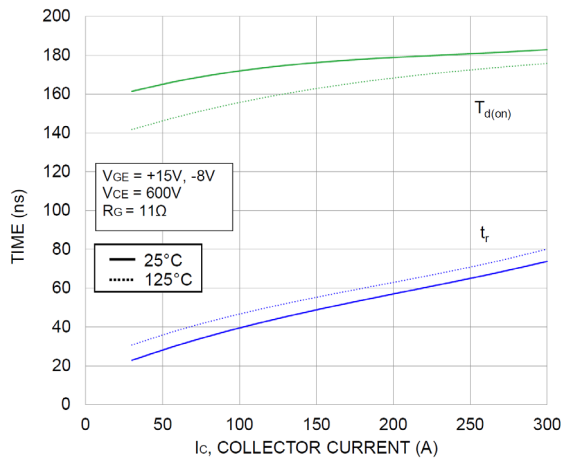

Figure 25. Typical Turn On Switching Time vs. I<sub>C</sub>

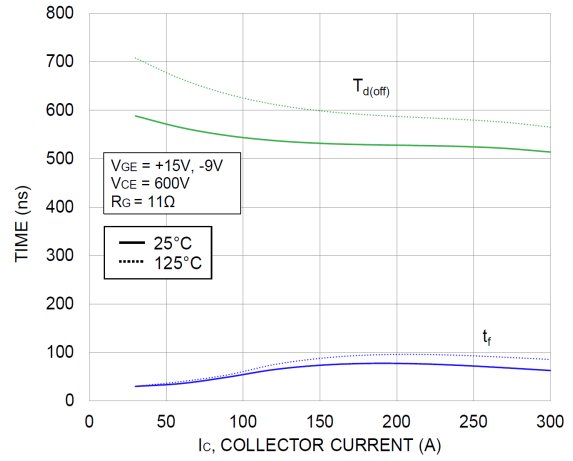

Figure 26. Typical Turn Off Switching Time vs. I<sub>C</sub>

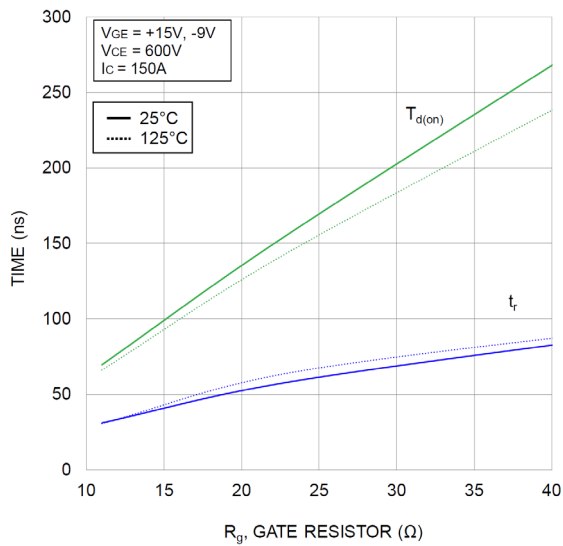

Figure 27. Typical Turn On Switching Time vs. R<sub>G</sub>

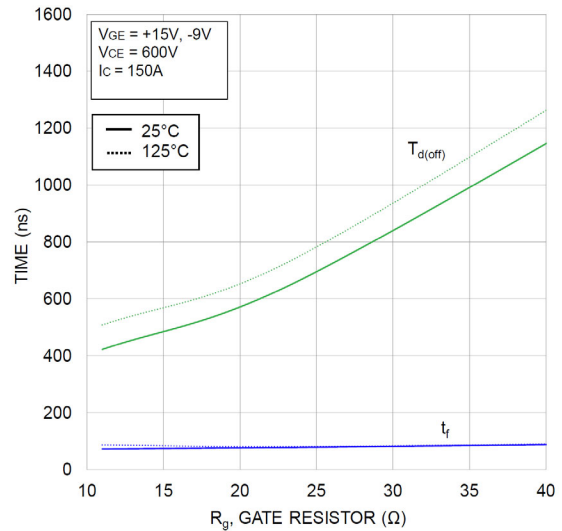

Figure 28. Typical Turn Off Switching Time vs. R<sub>G</sub>

TYPICAL SWITCHING CHARACTERISTICS – INVERSE DIODE

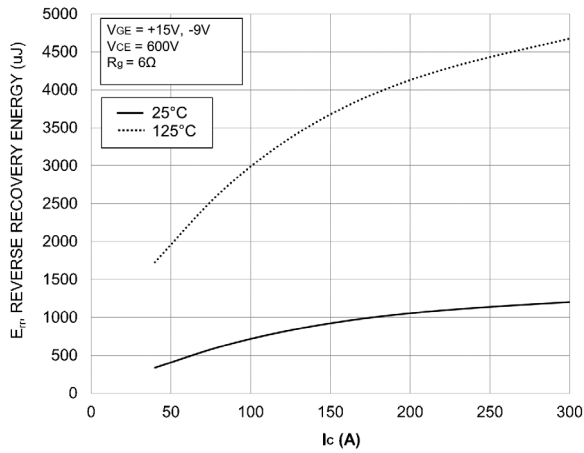

Figure 29. Typical Reverse Recovery Energy Loss vs.  $I_C$

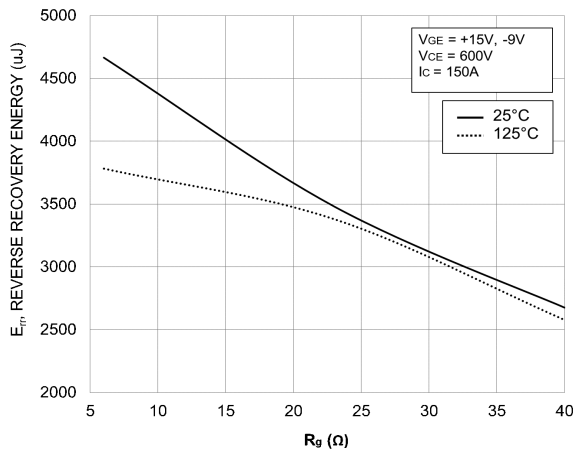

Figure 30. Typical Reverse Recovery Energy Loss vs.  $R_G$

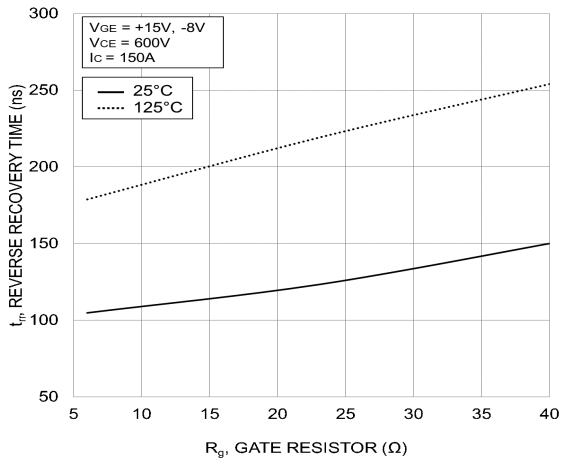

Figure 31. Typical Reverse Recovery Time vs.  $R_G$

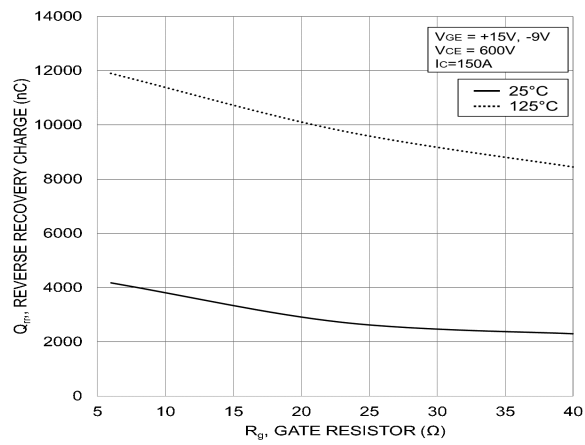

Figure 32. Typical Reverse Recovery Charge vs.  $R_G$

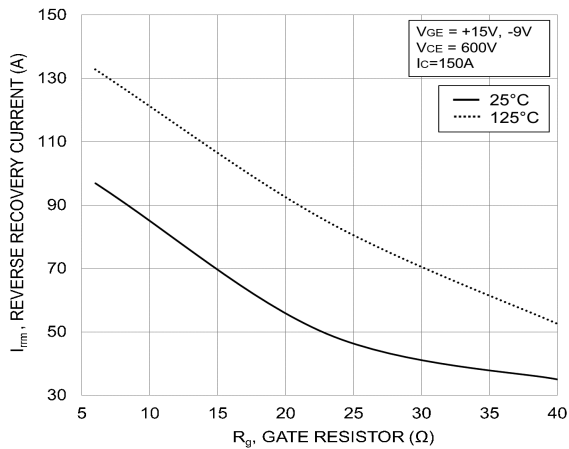

Figure 33. Typical Reverse Recovery Peak Current vs.  $R_G$

TYPICAL SWITCHING CHARACTERISTICS – NEUTRAL POINT DIODE

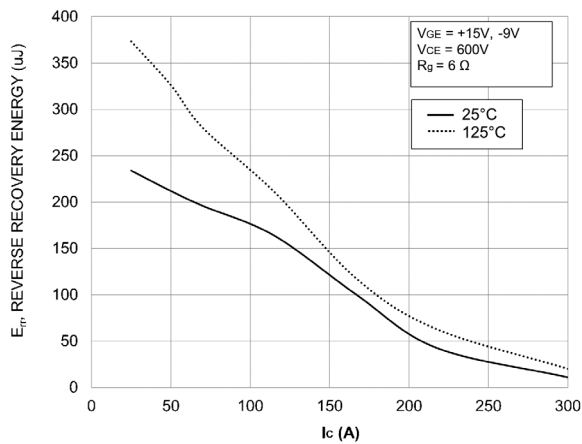

Figure 34. Typical Reverse Recovery Energy Loss vs.  $I_C$

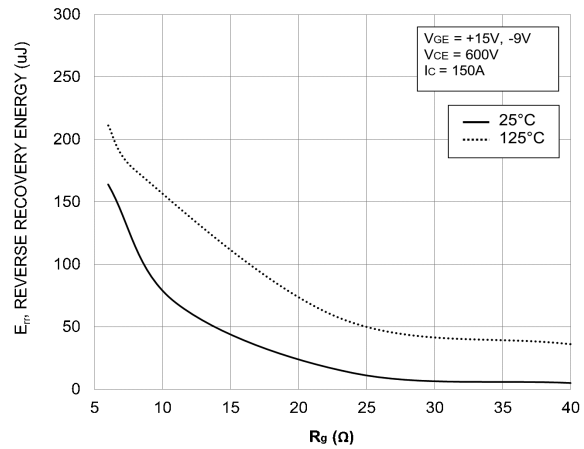

Figure 35. Typical Reverse Recovery Energy Loss vs.  $R_G$

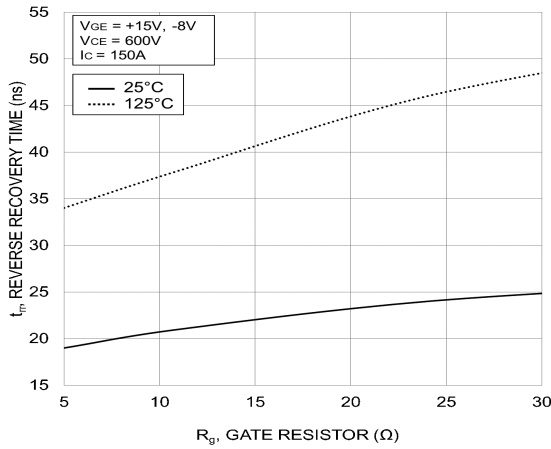

Figure 36. Typical Reverse Recovery Time vs.  $R_G$

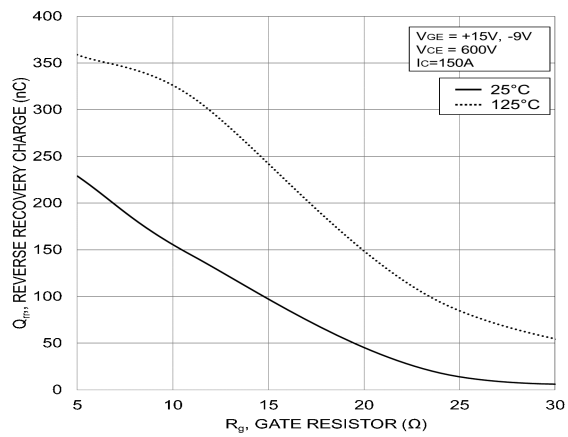

Figure 37. Typical Reverse Recovery Charge vs.  $R_G$

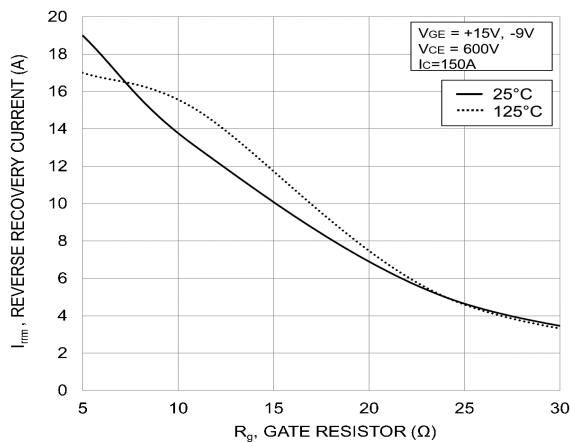

Figure 38. Typical Reverse Recovery Peak Current vs.  $R_G$

TRANSIENT THERMAL IMPEDANCE

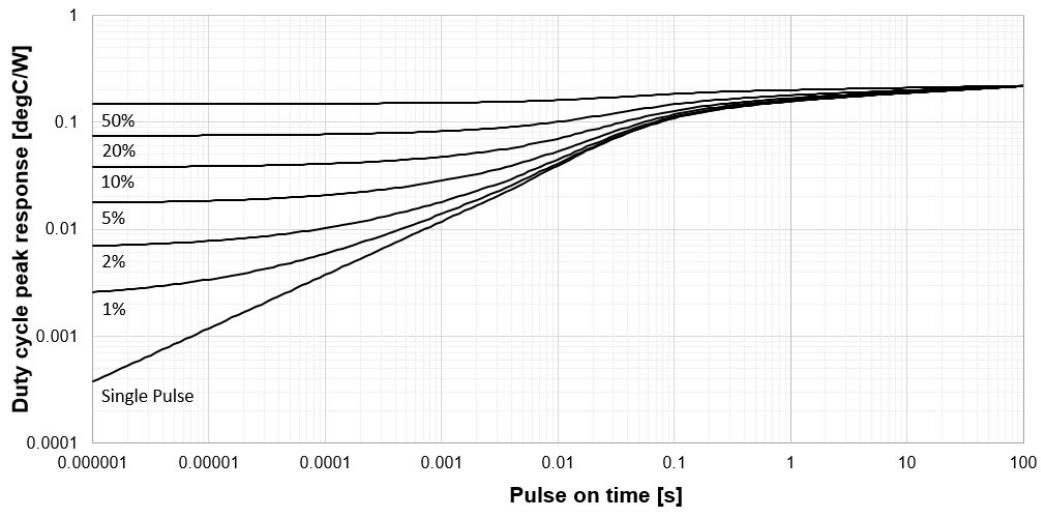

Figure 39. Transient Thermal Impedance – Outer IGBT

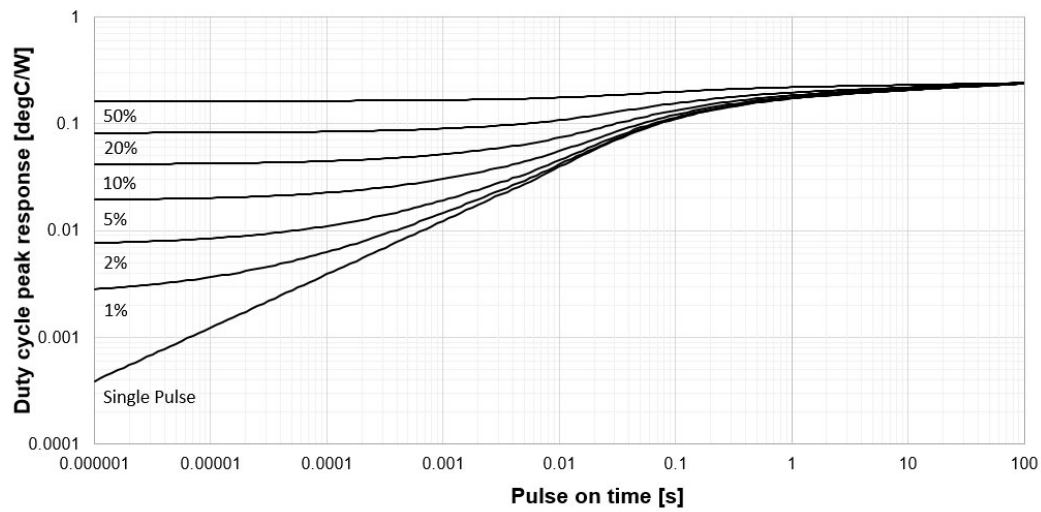

Figure 40. Transient Thermal Impedance – Inner IGBT

TRANSIENT THERMAL IMPEDANCE (Continued)

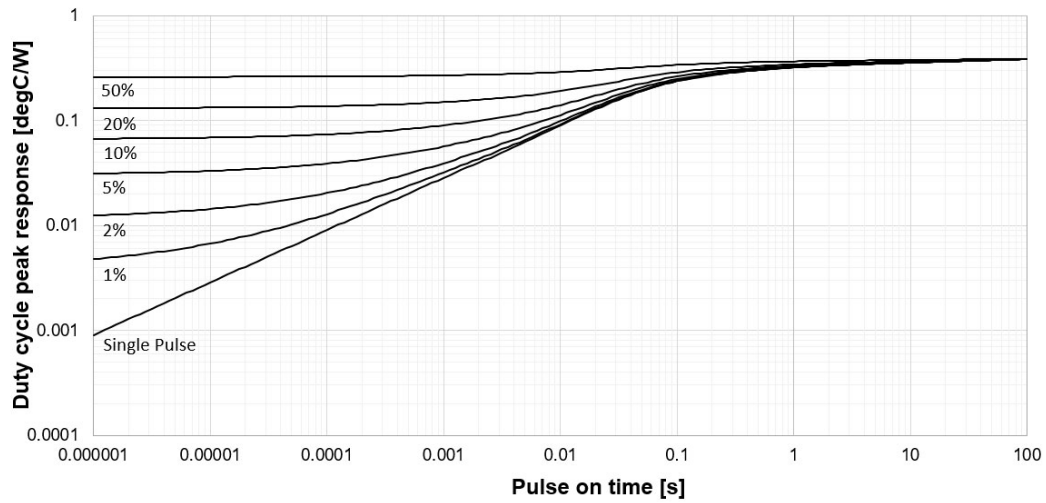

Figure 41. Transient Thermal Impedance – Inverse Diode

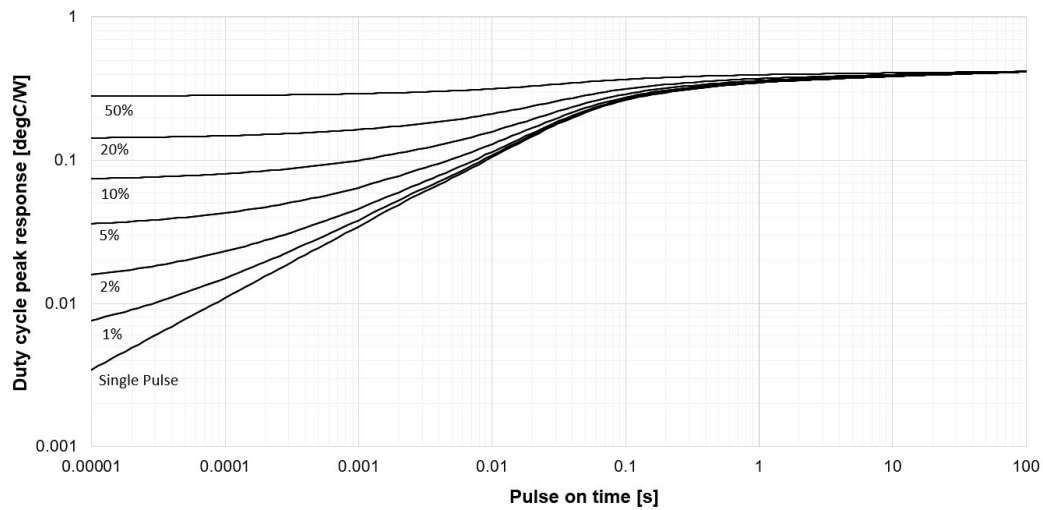

Figure 42. Transient Thermal Impedance – Neutral Point Diode

SAFE OPERATING AREA

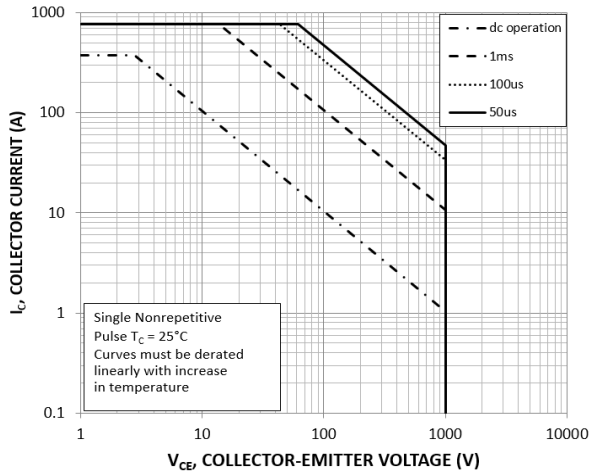

Figure 43. FBSOA – Outer IGBT

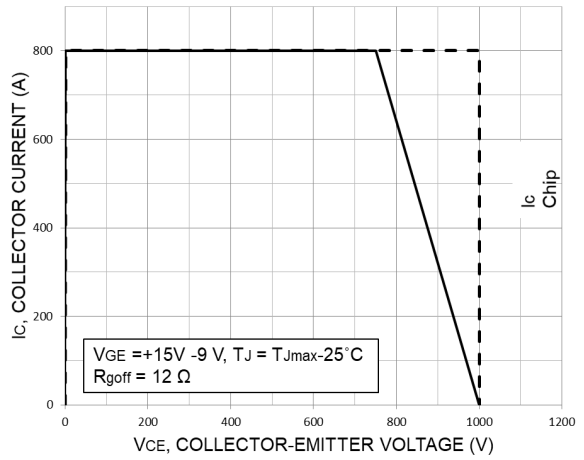

Figure 44. RBSOA – Outer IGBT

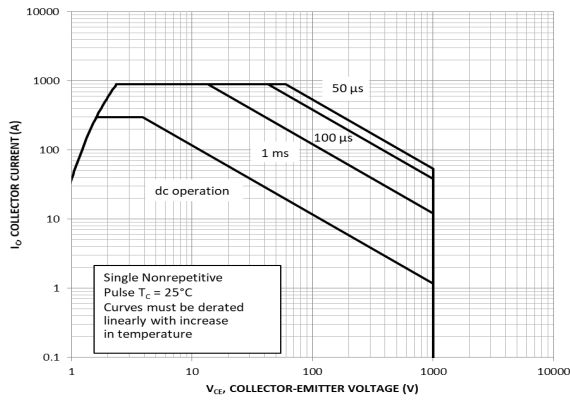

Figure 45. FBSOA – Inner IGBT

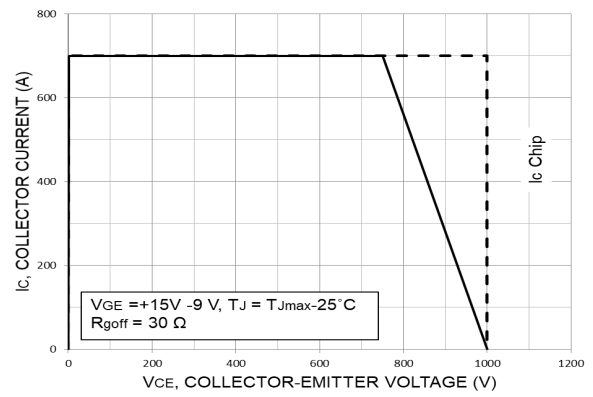

Figure 46. RBSOA – Inner IGBT

GATE CHARGE AND CAPACITANCE

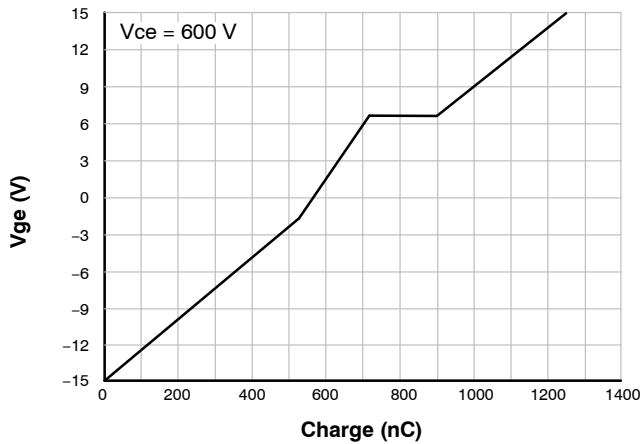

Figure 47. Gate Voltage vs. Gate Charge – Outer IGBT

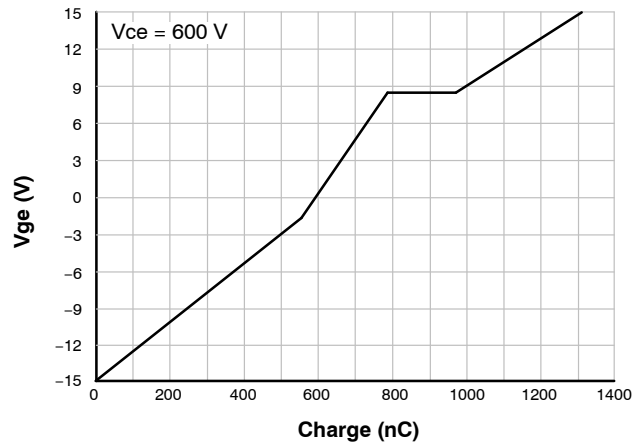

Figure 48. Gate Voltage vs. Gate Charge – Inner IGBT

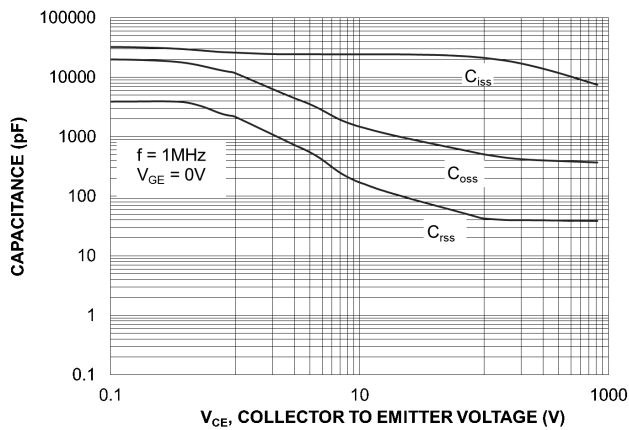

Figure 49. Capacitance Charge – Outer IGBT

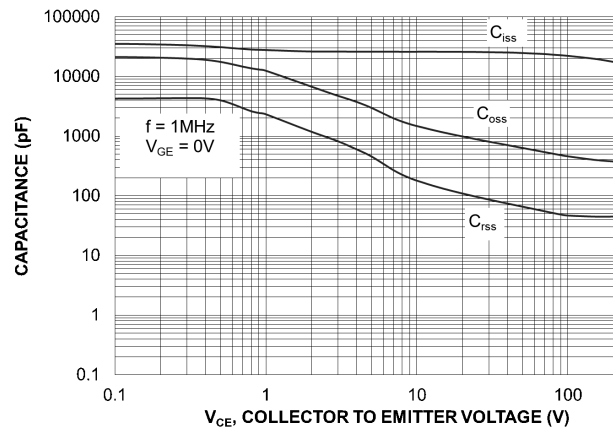

Figure 50. Capacitance Charge – Inner IGBT

TYPICAL CHARACTERISTICS – THERMISTOR

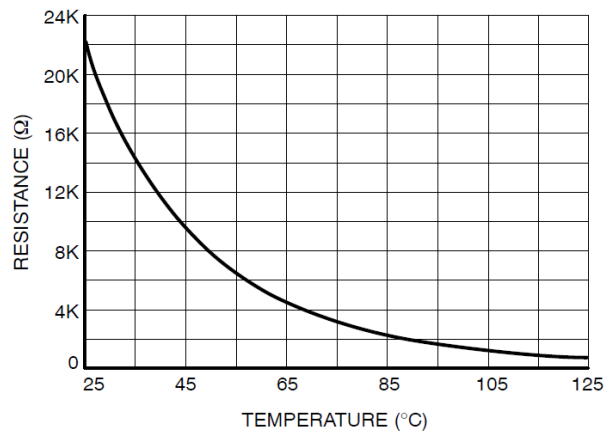

Figure 51. Thermistor Characteristics

# MECHANICAL CASE OUTLINE PACKAGE DIMENSIONS

ON Semiconductor®



## PIM42, 93x47 (PRESSFIT) CASE 180BH ISSUE O

DATE 06 AUG 2019

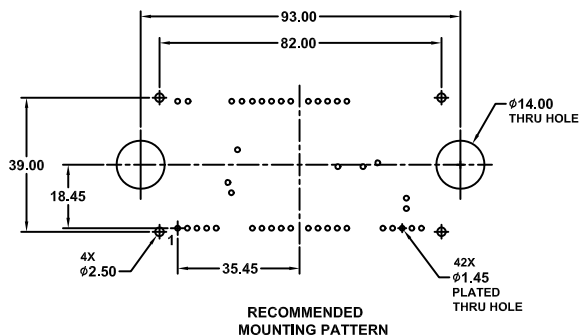
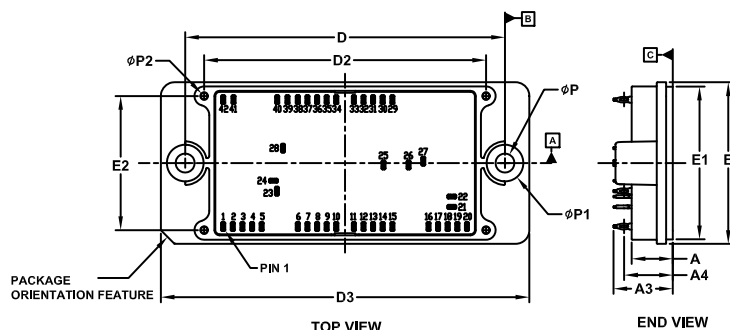
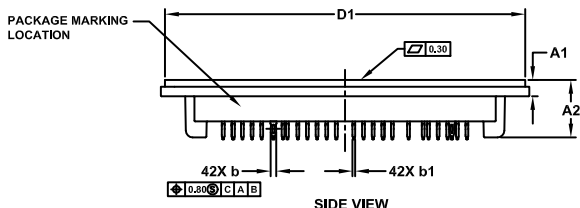
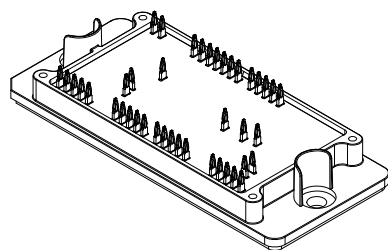

NOTES:

1. DIMENSIONING AND TOLERANCING PER ASME Y14.5M, 2009.
2. CONTROLLING DIMENSION: MILLIMETERS
3. DIMENSIONS b AND b1 APPLY TO THE PLATED TERMINALS AND ARE MEASURED AT DIMENSION A4.
4. POSITION OF THE CENTER OF THE TERMINALS IS DETERMINED FROM DATUM B THE CENTER OF DIMENSION D, X DIRECTION, AND FROM DATUM A, Y DIRECTION. POSITIONAL TOLERANCE, AS NOTED IN DRAWING, APPLIES TO EACH TERMINAL IN BOTH DIRECTIONS.
5. PACKAGE MARKING IS LOCATED AS SHOWN ON THE SIDE OPPOSITE THE PACKAGE ORIENTATION FEATURES.

DIM	MILLIMETERS			PIN POSITION		PIN POSITION			
	MIN.	NOM.	MAX.	X	Y	PIN	X	Y	
A	11.70	12.00	12.30	1	0.00	0.00	22	66.50	8.70
A1	4.40	4.70	5.00	2	2.80	0.00	23	15.60	10.30
A2	16.40	16.70	17.00	3	5.60	0.00	24	14.60	13.30
A3	16.90	17.30	17.70	4	8.40	0.00	25	46.60	17.90
A4	13.97	14.18	14.39	5	11.20	0.00	26	53.90	17.90
b	1.61	1.66	1.71	6	21.70	0.00	27	58.20	19.00
b1	0.75	0.80	0.85	7	24.50	0.00	28	17.40	22.80
D	92.90	93.00	93.10	8	27.30	0.00	29	49.20	36.90
D1	104.45	104.75	105.05	9	30.10	0.00	30	46.40	36.90
D2	81.80	82.00	82.20	10	32.90	0.00	31	43.60	36.90
D3	106.90	107.20	107.50	11	38.00	0.00	32	40.80	36.90
E	46.70	47.00	47.30	12	40.80	0.00	33	38.00	36.90
E1	44.10	44.40	44.70	13	43.60	0.00	34	32.90	36.90
E2	38.80	39.00	39.10	14	46.40	0.00	35	30.10	36.90
P	5.40	5.50	5.60	15	49.20	0.00	36	27.30	36.90
P1	10.60	10.70	10.80	16	59.70	0.00	37	24.50	36.90
P2	1.80	2.00	2.20	17	62.50	0.00	38	21.70	36.90
				18	65.30	0.00	39	18.70	36.90
				19	68.10	0.00	40	15.70	36.90
				20	70.90	0.00	41	3.00	36.90
				21	66.50	5.70	42	0.00	36.90

### GENERIC MARKING DIAGRAM\*

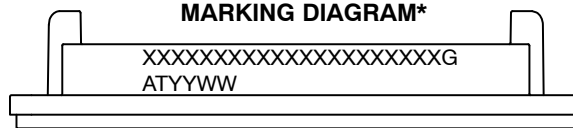

XXXXX = Specific Device Code  
G = Pb-Free Package  
AT = Assembly & Test Site Code  
YYWW = Year and Work Week Code

\*This information is generic. Please refer to device data sheet for actual part marking. Pb-Free indicator, "G" or microdot "μ", may or may not be present. Some products may not follow the Generic Marking.

DOCUMENT NUMBER:	98AON09951H	Electronic versions are uncontrolled except when accessed directly from the Document Repository. Printed versions are uncontrolled except when stamped "CONTROLLED COPY" in red.
DESCRIPTION:	PIM42 93X47 (PRESS FIT)	PAGE 1 OF 1

ON Semiconductor and are trademarks of Semiconductor Components Industries, LLC dba ON Semiconductor or its subsidiaries in the United States and/or other countries. ON Semiconductor reserves the right to make changes without further notice to any products herein. ON Semiconductor makes no warranty, representation or guarantee regarding the suitability of its products for any particular purpose, nor does ON Semiconductor assume any liability arising out of the application or use of any product or circuit, and specifically disclaims any and all liability, including without limitation special, consequential or incidental damages. ON Semiconductor does not convey any license under its patent rights nor the rights of others.

# MECHANICAL CASE OUTLINE

## PACKAGE DIMENSIONS

ON Semiconductor®



### PIM42, 93x47 (SOLDER PIN) CASE 180BS ISSUE O

DATE 03 DEC 2019

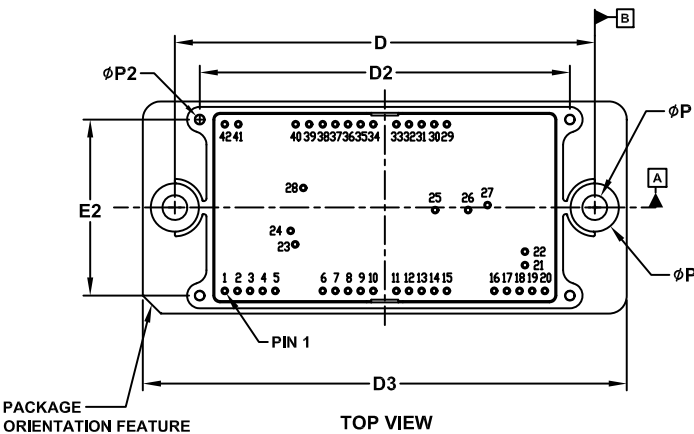
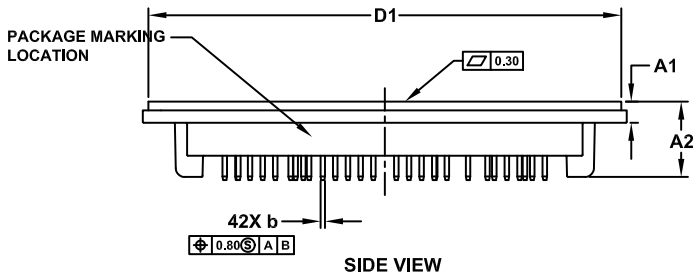
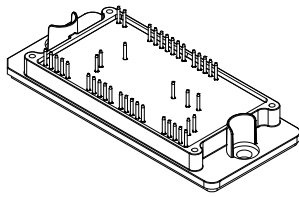

NOTES:

1. DIMENSIONING AND TOLERANCING PER ASME Y14.5M, 2009.
2. CONTROLLING DIMENSION: MILLIMETERS
3. DIMENSIONS b AND b1 APPLY TO THE PLATED TERMINALS AND ARE MEASURED AT DIMENSION A4.
4. POSITION OF THE CENTER OF THE TERMINALS IS DETERMINED FROM DATUM B THE CENTER OF DIMENSION D, X DIRECTION, AND FROM DATUM A, Y DIRECTION. POSITIONAL TOLERANCE, AS NOTED IN DRAWING, APPLIES TO EACH TERMINAL IN BOTH DIRECTIONS.
5. PACKAGE MARKING IS LOCATED AS SHOWN ON THE SIDE OPPOSITE THE PACKAGE ORIENTATION FEATURES.

DIM	MILLIMETERS		
	MIN.	NOM.	MAX.
A	11.70	12.00	12.30
A1	4.40	4.70	5.00
A2	16.40	16.70	17.00
A3	16.80	17.20	17.60
b	0.95	1.00	1.05
D	92.90	93.00	93.10
D1	104.45	104.75	105.05
D2	81.80	82.00	82.20
D3	106.90	107.20	107.50
E	46.70	47.00	47.30
E1	44.10	44.40	44.70
E2	38.80	39.00	39.10
P	5.40	5.50	5.60
P1	10.60	10.70	10.80
P2	1.80	2.00	2.20

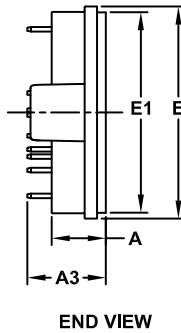

NOTE 4

PIN	PIN POSITION		PIN	PIN POSITION	
	X	Y		X	Y
1	0.00	0.00	22	66.50	8.70
2	2.80	0.00	23	15.60	10.30
3	5.60	0.00	24	14.60	13.30
4	8.40	0.00	25	46.60	17.90
5	11.20	0.00	26	53.90	17.90
6	21.70	0.00	27	58.20	19.00
7	24.50	0.00	28	17.40	22.80
8	27.30	0.00	29	49.20	36.90
9	30.10	0.00	30	46.40	36.90
10	32.90	0.00	31	43.60	36.90
11	38.00	0.00	32	40.80	36.90
12	40.80	0.00	33	38.00	36.90
13	43.60	0.00	34	32.90	36.90
14	46.40	0.00	35	30.10	36.90
15	49.20	0.00	36	27.30	36.90
16	59.70	0.00	37	24.50	36.90
17	62.50	0.00	38	21.70	36.90
18	65.30	0.00	39	18.70	36.90
19	68.10	0.00	40	15.70	36.90
20	70.90	0.00	41	3.00	36.90
21	66.50	5.70	42	0.00	36.90

### GENERIC MARKING DIAGRAM\*

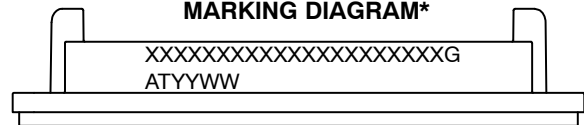

XXXXX = Specific Device Code  
G = Pb-Free Package  
AT = Assembly & Test Site Code  
YYWW = Year and Work Week Code

\*This information is generic. Please refer to device data sheet for actual part marking. Pb-Free indicator, "G" or microdot "•", may or may not be present. Some products may not follow the Generic Marking.

<b>DOCUMENT NUMBER:</b>	<b>98AON15232H</b>	Electronic versions are uncontrolled except when accessed directly from the Document Repository. Printed versions are uncontrolled except when stamped "CONTROLLED COPY" in red.
<b>DESCRIPTION:</b>	<b>PIM42 93X47 (SOLDER PIN)</b>	<b>PAGE 1 OF 1</b>

ON Semiconductor and ON are trademarks of Semiconductor Components Industries, LLC dba ON Semiconductor or its subsidiaries in the United States and/or other countries. ON Semiconductor reserves the right to make changes without further notice to any products herein. ON Semiconductor makes no warranty, representation or guarantee regarding the suitability of its products for any particular purpose, nor does ON Semiconductor assume any liability arising out of the application or use of any product or circuit, and specifically disclaims any and all liability, including without limitation special, consequential or incidental damages. ON Semiconductor does not convey any license under its patent rights nor the rights of others.

**onsemi**, **Onsemi**, and other names, marks, and brands are registered and/or common law trademarks of Semiconductor Components Industries, LLC dba "**onsemi**" or its affiliates and/or subsidiaries in the United States and/or other countries. **onsemi** owns the rights to a number of patents, trademarks, copyrights, trade secrets, and other intellectual property. A listing of **onsemi**'s product/patent coverage may be accessed at [www.onsemi.com/site/pdf/Patent-Marking.pdf](http://www.onsemi.com/site/pdf/Patent-Marking.pdf). **onsemi** reserves the right to make changes at any time to any products or information herein, without notice. The information herein is provided "as-is" and **onsemi** makes no warranty, representation or guarantee regarding the accuracy of the information, product features, availability, functionality, or suitability of its products for any particular purpose, nor does **onsemi** assume any liability arising out of the application or use of any product or circuit, and specifically disclaims any and all liability, including without limitation special, consequential or incidental damages. Buyer is responsible for its products and applications using **onsemi** products, including compliance with all laws, regulations and safety requirements or standards, regardless of any support or applications information provided by **onsemi**. "Typical" parameters which may be provided in **onsemi** data sheets and/or specifications can and do vary in different applications and actual performance may vary over time. All operating parameters, including "Typicals" must be validated for each customer application by customer's technical experts. **onsemi** does not convey any license under any of its intellectual property rights nor the rights of others. **onsemi** products are not designed, intended, or authorized for use as a critical component in life support systems or any FDA Class 3 medical devices or medical devices with a same or similar classification in a foreign jurisdiction or any devices intended for implantation in the human body. Should Buyer purchase or use **onsemi** products for any such unintended or unauthorized application, Buyer shall indemnify and hold **onsemi** and its officers, employees, subsidiaries, affiliates, and distributors harmless against all claims, costs, damages, and expenses, and reasonable attorney fees arising out of, directly or indirectly, any claim of personal injury or death associated with such unintended or unauthorized use, even if such claim alleges that **onsemi** was negligent regarding the design or manufacture of the part. **onsemi** is an Equal Opportunity/Affirmative Action Employer. This literature is subject to all applicable copyright laws and is not for resale in any manner.

## PUBLICATION ORDERING INFORMATION

### LITERATURE FULFILLMENT:

Email Requests to: [orderlit@onsemi.com](mailto:orderlit@onsemi.com)

**onsemi Website:** [www.onsemi.com](http://www.onsemi.com)

### TECHNICAL SUPPORT

**North American Technical Support:**

Voice Mail: 1 800-282-9855 Toll Free USA/Canada

Phone: 011 421 33 790 2910

**Europe, Middle East and Africa Technical Support:**

Phone: 00421 33 790 2910

For additional information, please contact your local Sales Representative

# Mouser Electronics

Authorized Distributor

Click to View Pricing, Inventory, Delivery & Lifecycle Information:

[onsemi:](#)

[NXH350N100H4Q2F2P1G](#) [NXH350N100H4Q2F2S1G](#)