

National Semiconductor is now part of
Texas Instruments.

Search <http://www.ti.com/> for the latest technical
information and details on our current products and services.

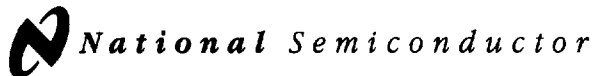

DS26C31T/DS26C31M CMOS Quad TRI-STATE® Differential Line Driver

General Description

The DS26C31 is a quad differential line driver designed for digital data transmission over balanced lines. The DS26C31T meets all the requirements of EIA standard RS-422 while retaining the low power characteristics of CMOS. The DS26C31M is compatible with EIA standard RS-422; however, one exception in test methodology is taken (see Note 8). This enables the construction of serial and terminal interfaces while maintaining minimal power consumption.

The DS26C31 accepts TTL or CMOS input levels and translates these to RS-422 output levels. This part uses special output circuitry that enables the drivers to power down without loading down the bus. This device has enable and disable circuitry common to all four drivers. The DS26C31 is pin compatible to the AM26LS31 and the DS26LS31.

All inputs are protected against damage due to electrostatic discharge by diodes to V_{CC} and ground.

Features

- TTL input compatible
- Typical propagation delays: 6 ns
- Typical output skew: 0.5 ns
- Outputs will not load line when $V_{CC} = 0V$
- DS26C31T meets the requirements of EIA standard RS-422
- Operation from single 5V supply
- TRI-STATE outputs for connection to system buses
- Low quiescent current
- Available in surface mount
- Mil-Std-883C compliant

Connection Diagrams

Dual-In-Line Package

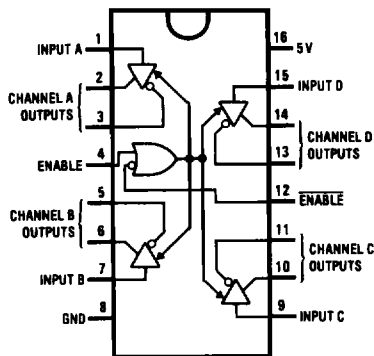

TL/F/8574-1

Top View

Order Number DS26C31TJ, DS26C31TM or DS26C31TN
See NS Package Number J16A, M16A or N16E

For Complete Military 883 Specifications,
See RETS Data Sheet

Order Number DS26C31ME/883, DS26C31MJ/883
or DS26C31MW/883

See NS Package Number E20A, J16A or W16A

20-Lead Ceramic Leadless Chip Carrier (E)

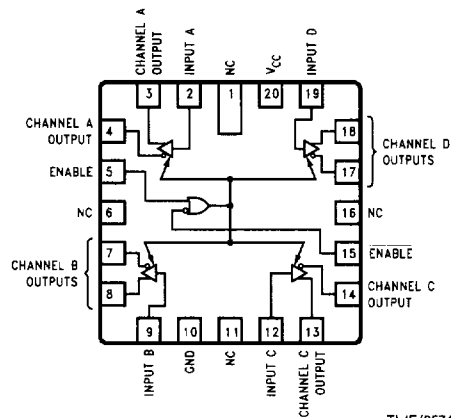

TL/F/8574-12

Truth Table

| ENABLE | ENABLE | Input | Non-Inverting Output | Inverting Output |
|---|--------|-------|----------------------|------------------|
| L | H | X | Z | Z |
| All other combinations of enable inputs | | L | L | H |
| | | H | H | L |

L = Low logic state
H = High logic state

X = Irrelevant
Z = TRI-STATE (high impedance)

Absolute Maximum Ratings (Notes 1 & 2)

If Military/Aerospace specified devices are required, please contact the National Semiconductor Sales Office/Distributors for availability and specifications.

| | |
|--|--------------------------|
| Supply Voltage (V_{CC}) | -0.5V to 7.0V |
| DC Input Voltage (V_{IN}) | -1.5V to $V_{CC} + 1.5V$ |
| DC Output Voltage (V_{OUT}) | -0.5V to 7V |
| Clamp Diode Current (I_{IK}, I_{OK}) | ± 20 mA |
| DC Output Current, per pin (I_{OUT}) | ± 150 mA |
| DC V_{CC} or GND Current, per pin (I_{CC}) | ± 150 mA |
| Storage Temperature Range (T_{STG}) | -65°C to +150°C |
| Max. Power Dissipation (P_D) @25°C (Note 3) | |
| Ceramic "J" Pkg. | 2419 mW |
| Plastic "N" Pkg. | 1736 mW |
| SOIC "M" Pkg. | 1226 mW |
| Ceramic "W" Pkg. | 1182 mW |
| Ceramic "E" Pkg. | 2134 mW |
| Lead Temperature (T_L) (Soldering, 4 sec.) | 260°C |

This device does not meet 2000V ESD Rating. (Note 13)

Operating Conditions

| | Min | Max | Units |
|--|------|----------|-------|
| Supply Voltage (V_{CC}) | 4.50 | 5.50 | V |
| DC Input or Output Voltage (V_{IN}, V_{OUT}) | 0 | V_{CC} | V |
| Operating Temperature Range (T_A) | | | |
| DS26C31T | -40 | +85 | °C |
| DS26C31M | -55 | +125 | °C |
| Input Rise or Fall Times (t_r, t_f) | | 500 | ns |

DC Electrical Characteristics $V_{CC} = 5V \pm 10\%$ (unless otherwise specified) (Note 4)

| Symbol | Parameter | Conditions | Min | Typ | Max | Units |
|---|-----------------------------------|---|-------------------------------------|-----------|-----------|---------|
| V_{IH} | High Level Input Voltage | | 2.0 | | | V |
| V_{IL} | Low Level Input Voltage | | | | 0.8 | V |
| V_{OH} | High Level Output Voltage | $V_{IN} = V_{IH}$ or V_{IL} , $I_{OUT} = -20$ mA | 2.5 | 3.4 | | V |
| V_{OL} | Low Level Output Voltage | $V_{IN} = V_{IH}$ or V_{IL} , $I_{OUT} = 20$ mA | | 0.3 | 0.5 | V |
| V_T | Differential Output Voltage | $R_L = 100\Omega$ (Note 5) | 2.0 | 3.1 | | V |
| $ \overline{V_T} - \overline{V_T} $ | Difference In Differential Output | $R_L = 100\Omega$ (Note 5) | | | 0.4 | V |
| V_{OS} | Common Mode Output Voltage | $R_L = 100\Omega$ (Note 5) | | 1.8 | 3.0 | V |
| $ \overline{V_{OS}} - \overline{V_{OS}} $ | Difference In Common Mode Output | $R_L = 100\Omega$ (Note 5) | | | 0.4 | V |
| I_{IN} | Input Current | $V_{IN} = V_{CC}, GND, V_{IH},$ or V_{IL} | | | ± 1.0 | μA |
| I_{CC} | Quiescent Supply Current (Note 6) | DS26C31T $I_{OUT} = 0 \mu A$ | $V_{IN} = V_{CC}$ or GND | 200 | 500 | μA |
| | | | $V_{IN} = 2.4V$ or 0.5V (Note 6) | 0.8 | 2.0 | mA |
| | | DS26C31M $I_{OUT} = 0 \mu A$ | $V_{IN} = V_{CC}$ or GND | 200 | 500 | μA |
| | | | $V_{IN} = 2.4V$ or 0.5V (Note 6) | 0.8 | 2.1 | mA |
| I_{OZ} | TRI-STATE Output Leakage Current | $V_{OUT} = V_{CC}$ or GND ENABLE = V_{IL} ENABLE = V_{IH} | | ± 0.5 | ± 5.0 | μA |

DC Electrical Characteristics $V_{CC} = 5V \pm 10\%$ (unless otherwise specified) (Note 4) (Continued)

| Symbol | Parameter | Conditions | Min | Typ | Max | Units |
|-----------|---|--|----------------------------|-----|------|---------|
| I_{SC} | Output Short Circuit Current | $V_{IN} = V_{CC}$ or GND (Notes 5, 7) | -30 | | -150 | mA |
| I_{OFF} | Output Leakage Current Power Off (Note 5) | DS26C31T $V_{CC} = 0V$ | $V_{OUT} = 6V$ | | 100 | μA |
| | | | $V_{OUT} = -0.25V$ | | -100 | μA |
| | | DS26C31M $V_{CC} = 0V$ | $V_{OUT} = 6V$ | | 100 | μA |
| | | | $V_{OUT} = 0V$ (Note 8) | | | -100 |

Note 1: Absolute Maximum Ratings are those values beyond which the safety of the device cannot be guaranteed. They are not meant to imply that the device should be operated at these limits. The table of "Electrical Characteristics" provide conditions for actual device operation.

Note 2: Unless otherwise specified, all voltages are referenced to ground. All currents into device pins are positive, all currents out of device pins are negative.

Note 3: Ratings apply to ambient temperature at 25°C. Above this temperature derate N package at 13.89 mW/°C, J package 16.13 mW/°C, M package 9.80 mW/°C, E package 12.20 mW/°C, and W package 6.75 mW/°C.

Note 4: Unless otherwise specified, min/max limits apply across the recommended operating temperature range. All typicals are given for $V_{CC} = 5V$ and $T_A = 25^\circ C$.

Note 5: See EIA Specification RS-422 for exact test conditions.

Note 6: Measured per input. All other inputs at V_{CC} or GND.

Note 7: This is the current sourced when a high output is shorted to ground. Only one output at a time should be shorted.

Note 8: The DS26C31M (-55°C to +125°C) is tested with V_{OUT} between +6V and 0V while RS-422A condition is +6V and -0.25V.

Switching Characteristics $V_{CC} = 5V \pm 10\%$, $t_r \leq 6$ ns, $t_f \leq 6$ ns (Figures 1, 2, 3 and 4) (Note 4)

| Symbol | Parameter | Conditions | Min | Typ | Max | | Units |
|-----------------------|---|------------|-----|-----|----------|----------|-------|
| | | | | | DS26C31T | CS26C31M | |
| t_{PLH} , t_{PHL} | Propagation Delays Input to Output | S1 Open | 2 | 6 | 11 | 14 | ns |
| Skew | (Note 9) | S1 Open | | 0.5 | 2.0 | 3.0 | ns |
| t_{TLH} , t_{THL} | Differential Output Rise And Fall Times | S1 Open | | 6 | 10 | 14 | ns |
| t_{PZH} | Output Enable Time | S1 Closed | | 11 | 19 | 22 | ns |
| t_{PZL} | Output Enable Time | S1 Closed | | 13 | 21 | 28 | ns |
| t_{PHZ} | Output Disable Time (Note 10) | S1 Closed | | 5 | 9 | 12 | ns |
| t_{PLZ} | Output Disable Time (Note 10) | S1 Closed | | 7 | 11 | 14 | ns |
| C_{PD} | Power Dissipation Capacitance (Note 11) | | | 50 | | | pF |
| C_{IN} | Input Capacitance | | | 6 | | | pF |

Note 9: Skew is defined as the difference in propagation delays between complementary outputs at the 50% point.

Note 10: Output disable time is the delay from ENABLE or \overline{ENABLE} being switched to the output transistors turning off. The actual disable times are less than indicated due to the delay added by the RC time constant of the load.

Note 11: C_{PD} determines the no load dynamic power consumption, $P_D = C_{PD} V_{CC}^2 f + I_{CC} V_{CC}$, and the no load dynamic current consumption, $I_S = C_{PD} V_{CC} f + I_{CC}$.

Comparison Table of Switching Characteristics into "LS-Type" Load

$V_{CC} = 5V$, $T_A = 25^\circ C$, $t_r \leq 6$ ns, $t_f \leq 6$ ns (Figures 2, 4, 5 and 6) (Note 12)

| Symbol | Parameter | Conditions | DS26C31T | | DS26LS31C | | Units |
|-----------------------|--|---|----------|-----|-----------|-----|-------|
| | | | Typ | Max | Typ | Max | |
| t_{PLH} , t_{PHL} | Propagation Delays Input to Output | $C_L = 30$ pF S1 Closed S2 Closed | 6 | 8 | 10 | 15 | ns |
| Skew | (Note 9) | $C_L = 30$ pF S1 Closed S2 Closed | 0.5 | 1.0 | 2.0 | 6.0 | ns |
| t_{THL} , t_{TLH} | Differential Output Rise and Fall Times | $C_L = 30$ pF S1 Closed S2 Closed | 4 | 6 | | | ns |
| t_{PLZ} | Output Disable Time (Note 10) | $C_L = 10$ pF S1 Closed S2 Open | 6 | 9 | 15 | 35 | ns |
| t_{PHZ} | Output Disable Time (Note 10) | $C_L = 10$ pF S1 Open S2 Closed | 4 | 7 | 15 | 25 | ns |
| t_{PZL} | Output Enable Time | $C_L = 30$ pF S1 Closed S2 Open | 14 | 20 | 20 | 30 | ns |
| t_{PZH} | Output Enable Time | $C_L = 30$ pF S1 Open S2 Closed | 11 | 17 | 20 | 30 | ns |

Note 12: This table is provided for comparison purposes only. The values in this table for the DS26C31 reflect the performance of the device but are not tested or guaranteed.

Note 13: ESD Rating: HBM (1.5 k Ω , 100 pF)
Inputs $\geq 1500V$
Outputs $\geq 1000V$
EIAJ (0 Ω , 200 pF) $\geq 350V$

Logic Diagram

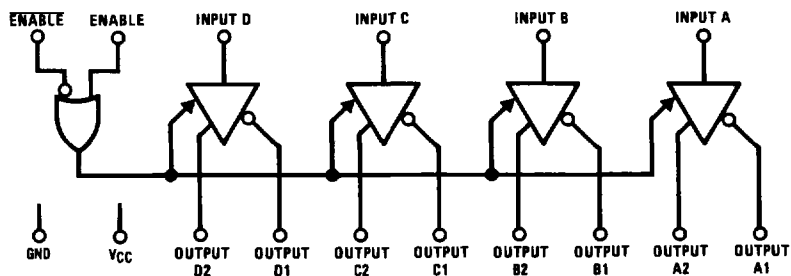

TL/F/8574-2

AC Test Circuit and Switching Time Waveforms

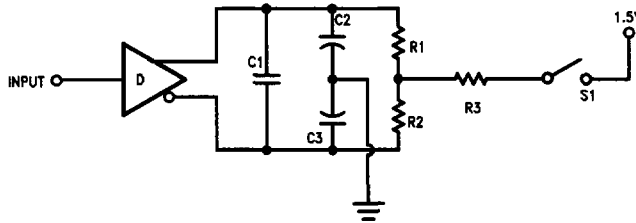

Note: C1 = C2 = C3 = 40 pF (including Probe and Jig Capacitance), R1 = R2 = 50Ω, R3 = 500Ω.

FIGURE 1. AC Test Circuit

TL/F/8574-3

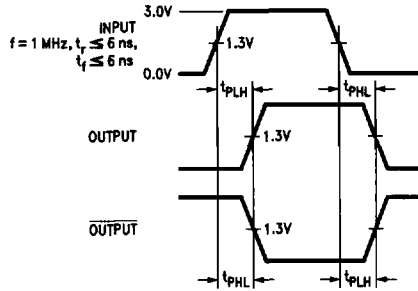

FIGURE 2. Propagation Delays

TL/F/8574-4

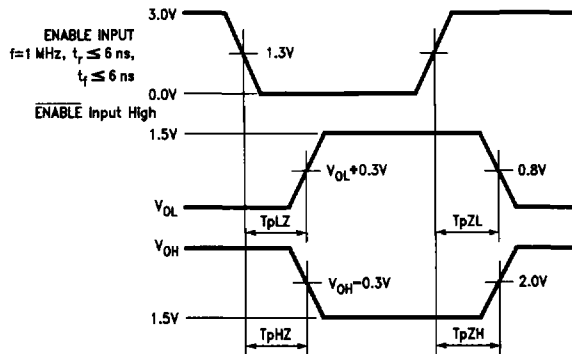
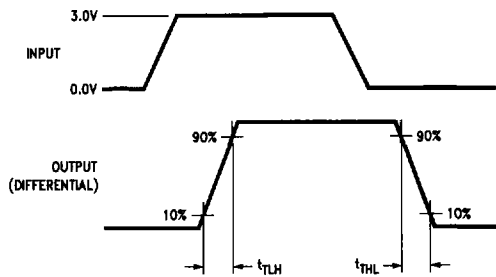

FIGURE 3. Enable and Disable Times

TL/F/8574-5



TL/F/8574-7

Input pulse: f = 1 MHz, 50%; tr ≤ 6 ns, tf ≤ 6 ns

FIGURE 4. Differential Rise and Fall Times

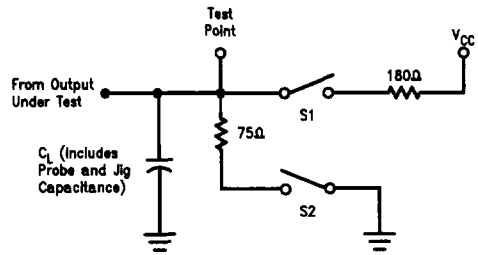

TL/F/8574-6

FIGURE 5. Load AC Test Circuit for "LS-Type" Load

AC Test Circuit and Switching Time Waveforms (Continued)

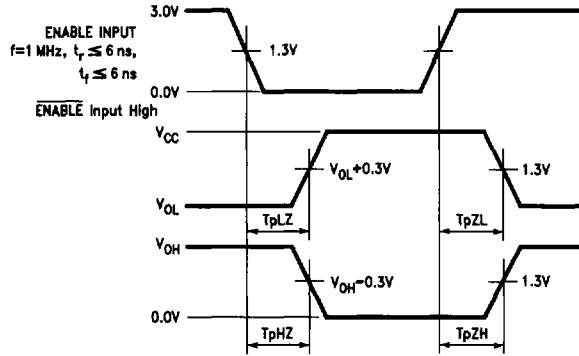
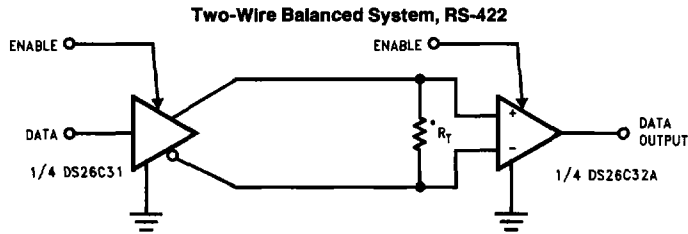

FIGURE 6. Enable and Disable Times for "LS-Type" Load

TL/F/8574-8

Typical Applications



* R_T is optional although highly recommended to reduce reflection.

TL/F/8574-9

Typical Performance Characteristics

Differential Propagation Delay vs Temperature

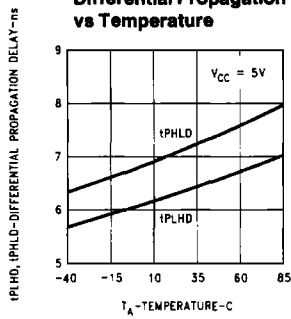

Differential Propagation Delay vs Power Supply Voltage

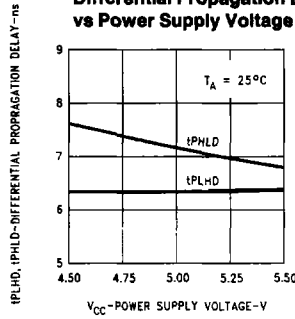

Differential Skew vs Temperature

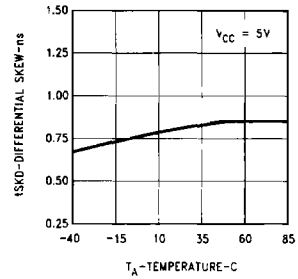

Differential Skew vs Power Supply Voltage

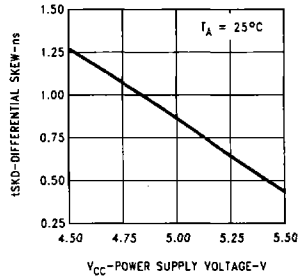

Differential Transition Time vs Temperature

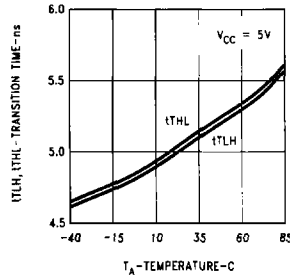

Differential Transition Time vs Power Supply Voltage

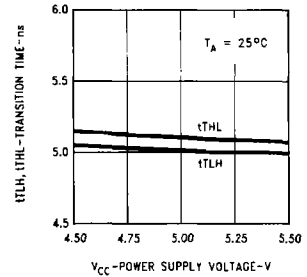

Complementary Skew vs Temperature

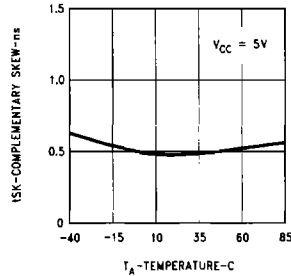

Complementary Skew vs Power Supply Voltage

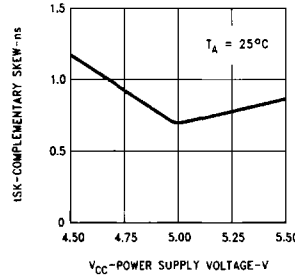

Differential Output Voltage vs Output Current

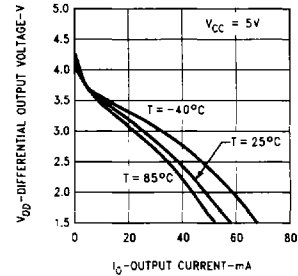

Differential Output Voltage vs Output Current

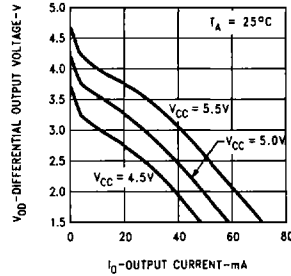

Output High Voltage vs Output High Current

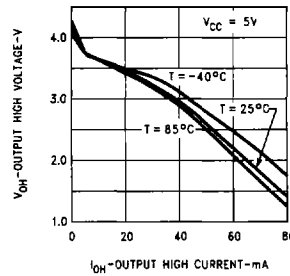

Output High Voltage vs Output High Current

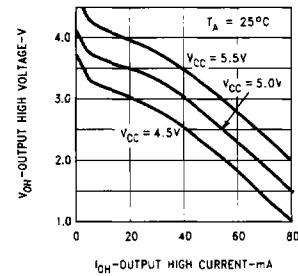

TL/F/8574-10

Typical Performance Characteristics (Continued)

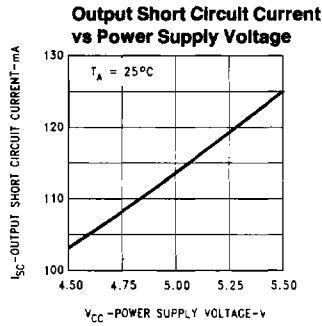
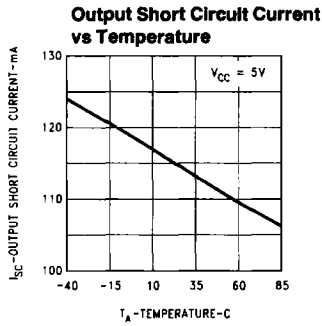
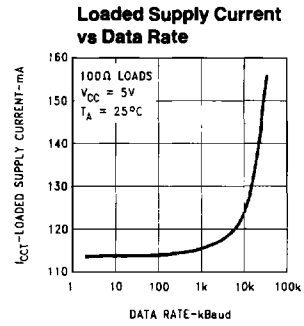
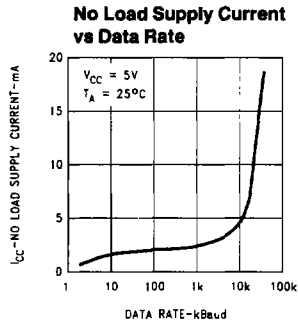
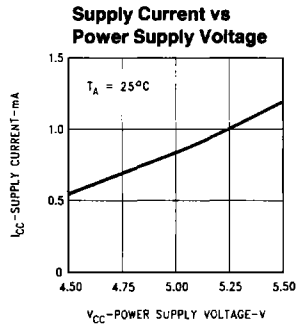
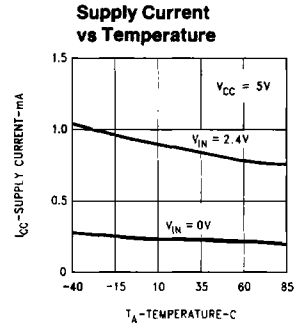
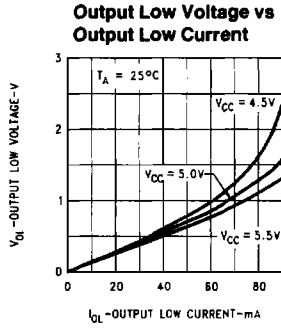
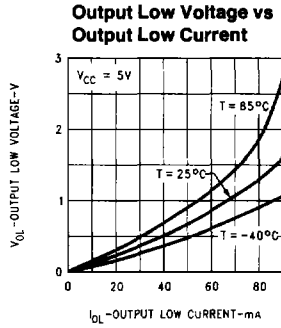

TL/F/8574-11