

ITS23F06

POWERLINE N-CHANNEL IGBT

The ITS23F06 is a robust n-channel, enhancement mode insulated gate bipolar transistor (IGBT) designed for low power dissipation in a wide range of high voltage applications such as power supplies and motor drives. The high impedance gate simplifies gate drive considerations, allowing operation directly from low power control circuitry.

Fast rise and fall times allow very high frequency switching making the device suitable for modern systems employing high frequency switching.

Low saturation voltages minimise power dissipation, thereby reducing the cost of the overall system in which they are used.

The ITS is fully short circuit rated making it especially suited for motor control and other applications requiring short circuit withstand capacity. Each device in the Powerline range is available with or without an integral anti-parallel ultrafast soft recovery diode, see separate datasheet for co-pack device.

Typical applications include high frequency inverters for motor control, welding and heating apparatus. The Powerline range of IGBTs is also applicable to switched mode and uninterruptible power supplies.

FEATURES

- Enhancement Mode n-Channel Device
- High Switching Speed
- Low On-state Saturation Voltage
- High Input Impedance Simplifies Gate Drive
- Latch-Free Operation
- Short Circuit Rated

APPLICATIONS

- High Frequency Inverters
- Motor Control
- Switched Mode Power Supplies
- High Frequency Welding
- Heating/Cooking Apparatus

ORDERING INFORMATION

ITS23F06P TO247

KEY PARAMETERS

V_{CES}	(max)	600V
$V_{CE(sat)}$	(typ)	2.0V
I_{C25}	(max)	40A
I_{C85}	(max)	23A
I_{CM}	(max)	46A
t_{sc}	(max)	10 μ s

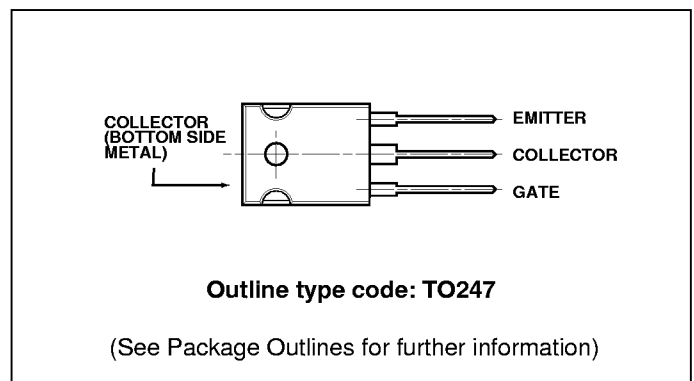

Fig.1 Pin connections - top view (not to scale)

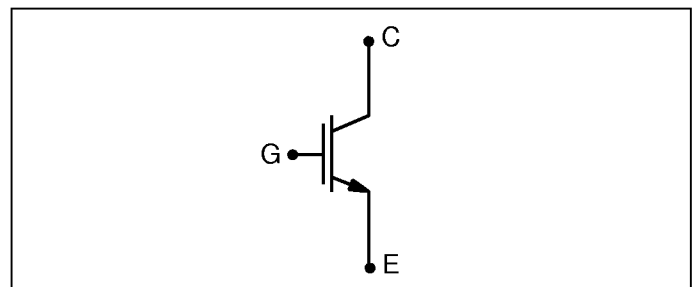

Fig.2 ITS23F06 circuit

ITS23F06

ABSOLUTE MAXIMUM RATINGS

Stresses above those listed under 'Absolute Maximum Ratings' may cause permanent damage to the device. This is a stress rating only and functional operation of the device at these or any other conditions above those indicated in the operational sections of this specification is not implied. Exposure to Absolute Maximum Ratings for extended periods may affect device reliability.

$T_{case} = 25^{\circ}\text{C}$ unless stated otherwise.

Symbol	Parameter	Test Conditions	Max.	Units
V_{CES}	Collector-emitter voltage	$V_{GE} = 0\text{V}$	600	V
V_{GES}	Gate-emitter voltage	-	± 20	V
I_{C25}	Continuous collector current	$T_{case} = 25^{\circ}\text{C}$	40	A
I_{C85}	Continuous collector current	$T_{case} = 85^{\circ}\text{C}$	23	A
I_{CM}	Pulsed collector current	1 ms, $T_{case} = 85^{\circ}\text{C}$	46	A
P_{tot}	Power dissipation	$T_{case} = 85^{\circ}\text{C}$	80	W

THERMAL AND MECHANICAL RATINGS

Symbol	Parameter	Conditions	Min.	Max.	Units
$R_{th(j-c)}$	Thermal resistance	DC junction to case	-	0.8	$^{\circ}\text{C}/\text{W}$
T_{OP}	Operating junction temperature range	-	-40	150	$^{\circ}\text{C}$
T_{stg}	Storage temperature range	-	-40	150	$^{\circ}\text{C}$
-	Mounting torque	M3 screw	-	1.1	Nm

DC ELECTRICAL CHARACTERISTICS

$T_{case} = 25^{\circ}\text{C}$ unless stated otherwise.

Symbol	Parameter	Conditions	Min.	Typ.	Max.	Units
I_{CES}	Collector cut-off current	$V_{GE} = 0\text{V}$, $V_{CE} = 600\text{V}$	-	-	1	mA
I_{GES}	Gate leakage current	$V_{GE} = 20\text{V}$, $V_{CE} = 0\text{V}$	-	-	± 500	nA
$V_{GE(TH)}$	Gate threshold voltage	$I_C = 1\text{mA}$, $V_{CE} = V_{GE}$	4	6	7.5	V
$V_{CE(SAT)}$	Collector-emitter saturation voltage	$V_{GE} = 15\text{V}$, $I_C = 23\text{A}$	-	2.0	2.6	V
		$V_{GE} = 15\text{V}$, $I_C = 23\text{A}$, $T_j = 125^{\circ}\text{C}$	-	2.2	-	V

AC ELECTRICAL CHARACTERISTICS

 $T_{\text{case}} = 25^{\circ}\text{C}$ unless stated otherwise.

Symbol	Parameter	Conditions	Min.	Typ.	Max.	Units
C_{ies}	Input capacitance	$V_{\text{CE}} = 25\text{V}$, $V_{\text{GE}} = 15\text{V}$, $f = 1\text{MHz}$	-	2000	-	pF
C_{oes}	Output capacitance	$V_{\text{CE}} = 25\text{V}$, $V_{\text{GE}} = 15\text{V}$, $f = 1\text{MHz}$	-	520	-	pF
C_{res}	Reverse transfer capacitance	$V_{\text{CE}} = 25\text{V}$, $V_{\text{GE}} = 15\text{V}$, $f = 1\text{MHz}$	-	450	-	pF

INDUCTIVE SWITCHING CHARACTERISTICS - see figures 3 to 5

 $T_{\text{case}} = 25^{\circ}\text{C}$ unless stated otherwise.

Symbol	Parameter	Conditions	Min.	Typ.	Max.	Units
$t_{\text{d(ON)}}$	Turn-on delay time	$I_{\text{C}} = 23\text{A}$, $V_{\text{GE}} = \pm 15\text{V}$, $V_{\text{CE}} = 50\%V_{\text{ces}}$ $R_{\text{G(ON)}} = R_{\text{G(OFF)}} = 25\Omega$	-	200	-	ns
t_{r}	Rise time		-	32	-	ns
E_{ON}	Turn-on energy loss - per cycle		-	0.4	-	mJ
$t_{\text{d(OFF)}}$	Turn-off delay time		-	300	-	ns
t_{f}	Fall time		-	270	500	ns
E_{OFF}	Turn-off energy loss - per cycle		-	1.6	-	mJ

 $T_{\text{case}} = 125^{\circ}\text{C}$ unless stated otherwise.

$t_{\text{d(ON)}}$	Turn-on delay time	$I_{\text{C}} = 23\text{A}$, $V_{\text{GE}} = \pm 15\text{V}$, $V_{\text{CE}} = 50\%V_{\text{ces}}$ $R_{\text{G(ON)}} = R_{\text{G(OFF)}} = 25\Omega$	-	210	-	ns
t_{r}	Rise time		-	40	-	ns
E_{ON}	Turn-on energy loss - per cycle		-	0.48	-	mJ
$t_{\text{d(OFF)}}$	Turn-off delay time		-	320	-	ns
t_{f}	Fall time		-	520	-	ns
E_{OFF}	Turn-off energy loss - per cycle		-	2.3	-	mJ

SHORT CIRCUIT RATING

Symbol	Parameter	Conditions	Min.	Typ.	Max.	Units
t_{sc}	Short circuit withstand time	$T_{\text{c}} = 125^{\circ}\text{C}$, $V_{\text{GE}} = 15\text{V}$, $V_{\text{CE}} = 50\% V_{\text{CES}}$	-	-	10	μs

BASIC TEST CIRCUIT AND SWITCHING DEFINITIONS

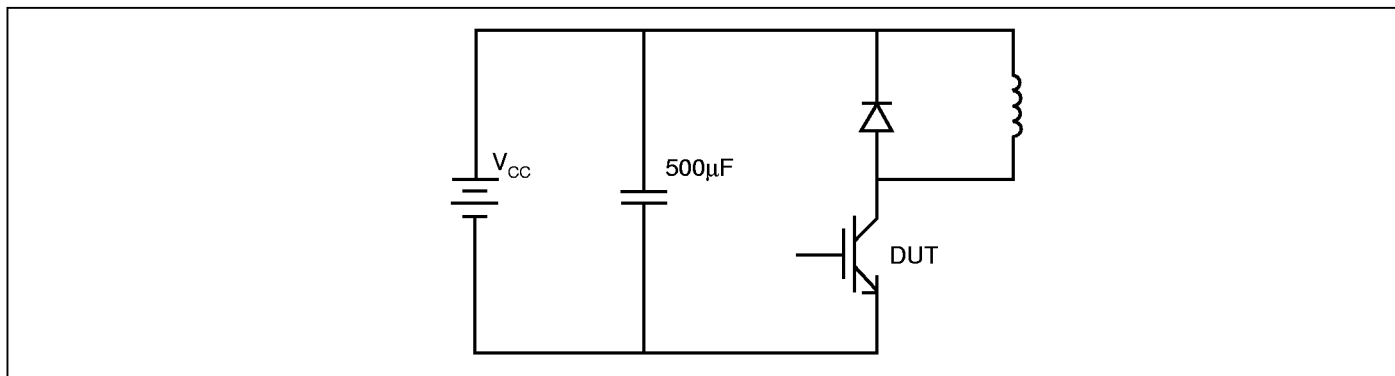

Fig.3 Basic d.c. chopper circuit

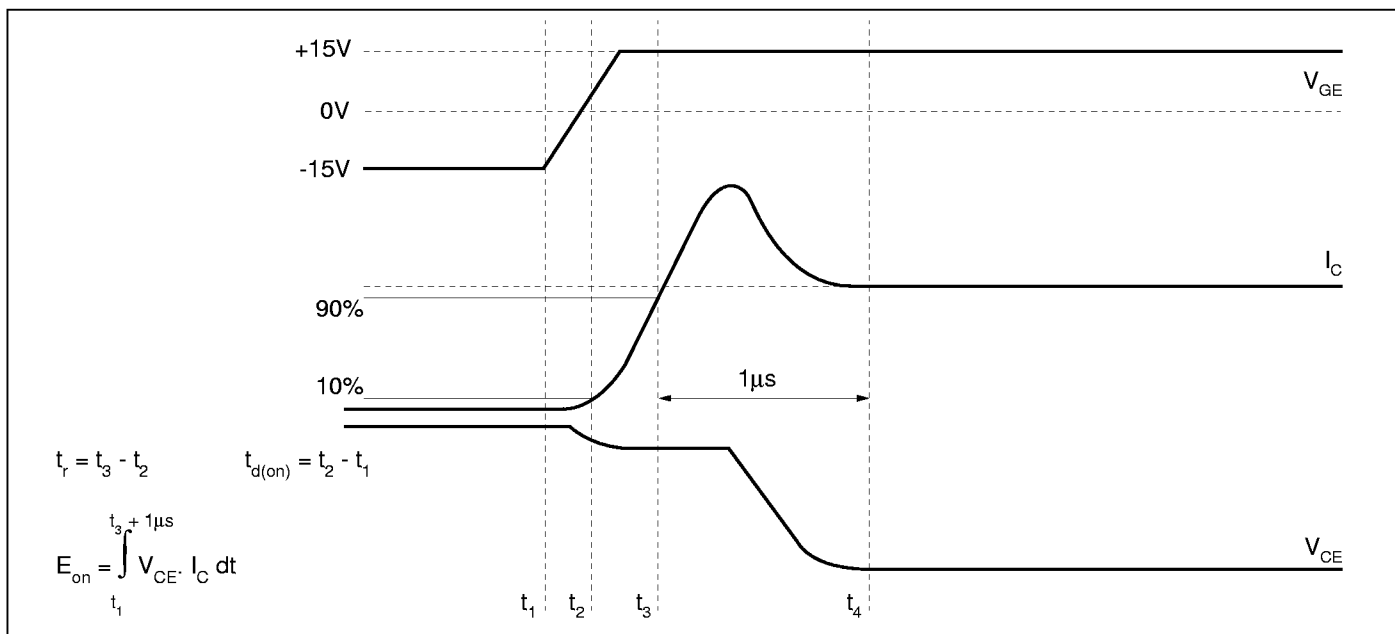

Fig.4 Turn-on characteristics

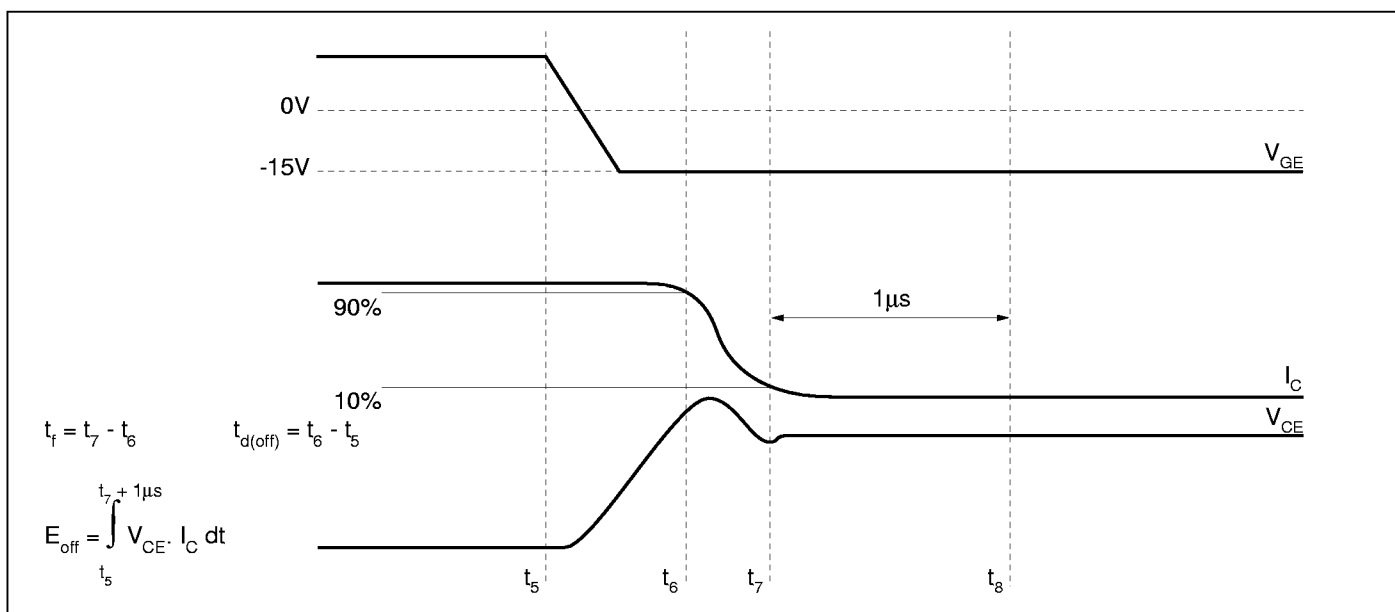

Fig.5 Turn-off characteristics

CURVES

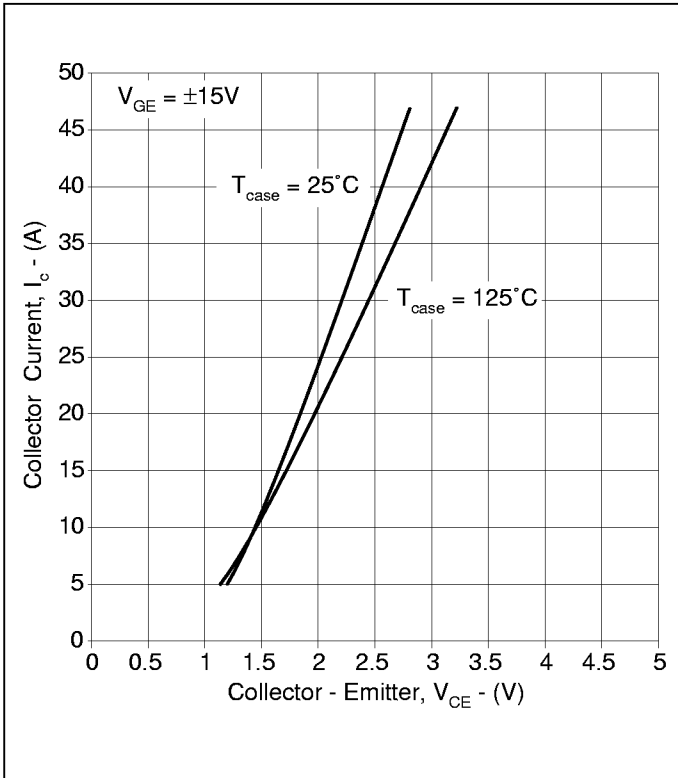

Fig.6 Typical output characteristics

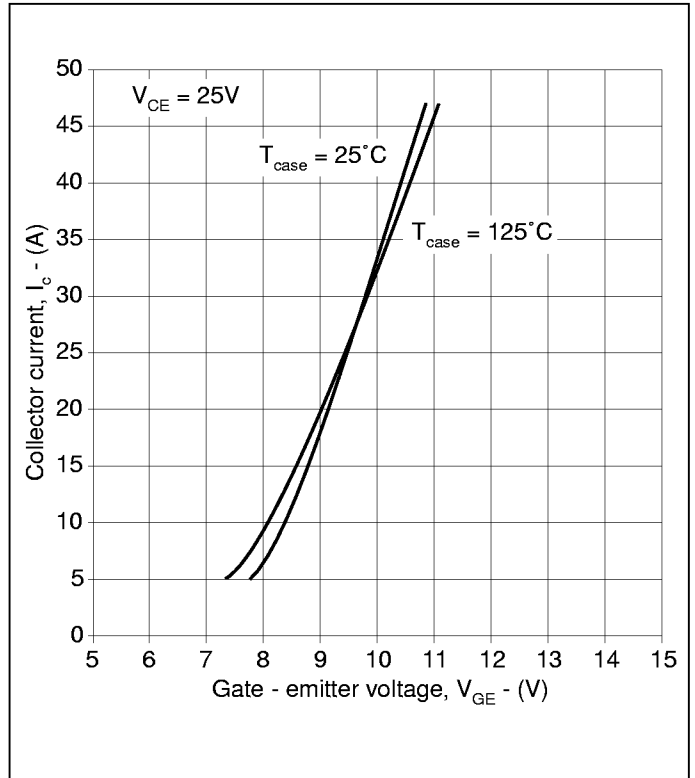

Fig.7 Typical transfer characteristics

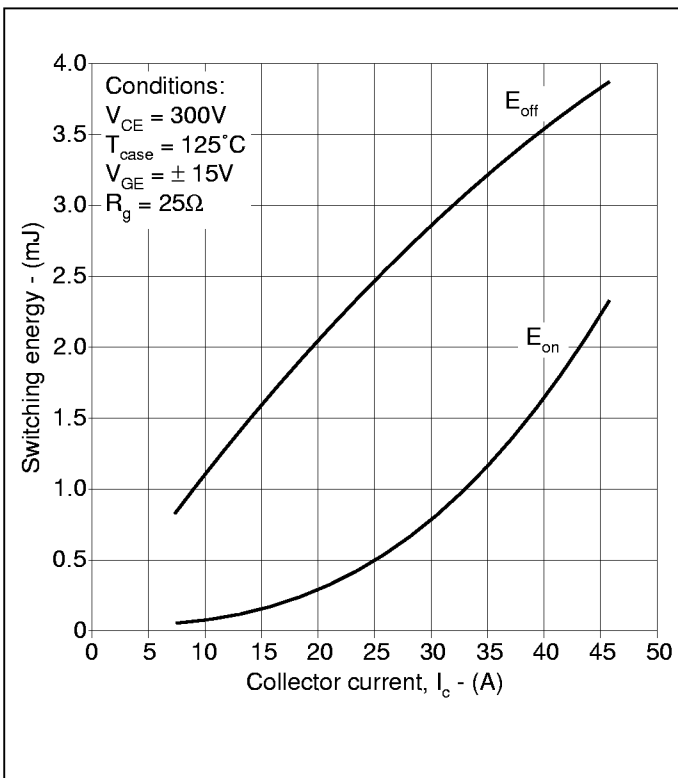

Fig.8 Typical switching losses vs collector current

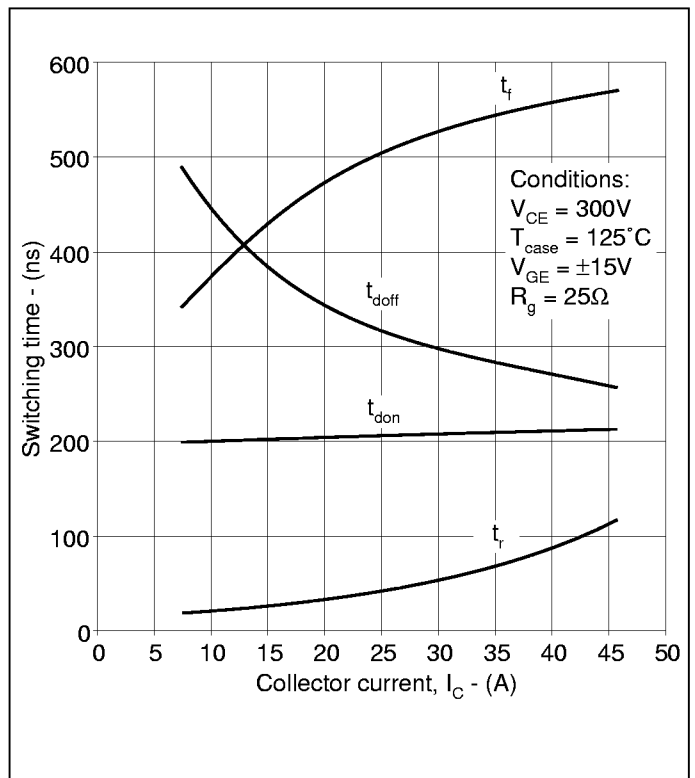

Fig.9 Typical switching times vs collector current

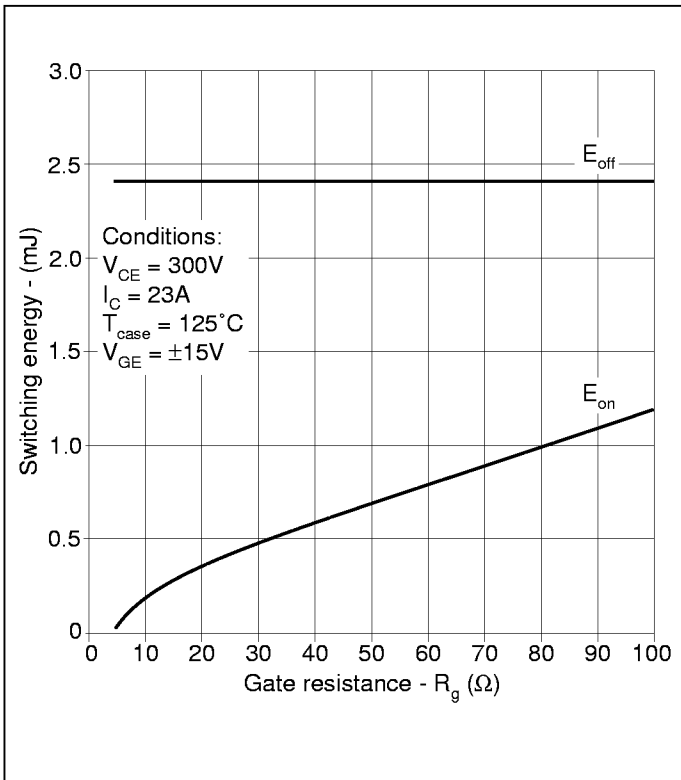

Fig.10 Typical switching losses vs gate resistance

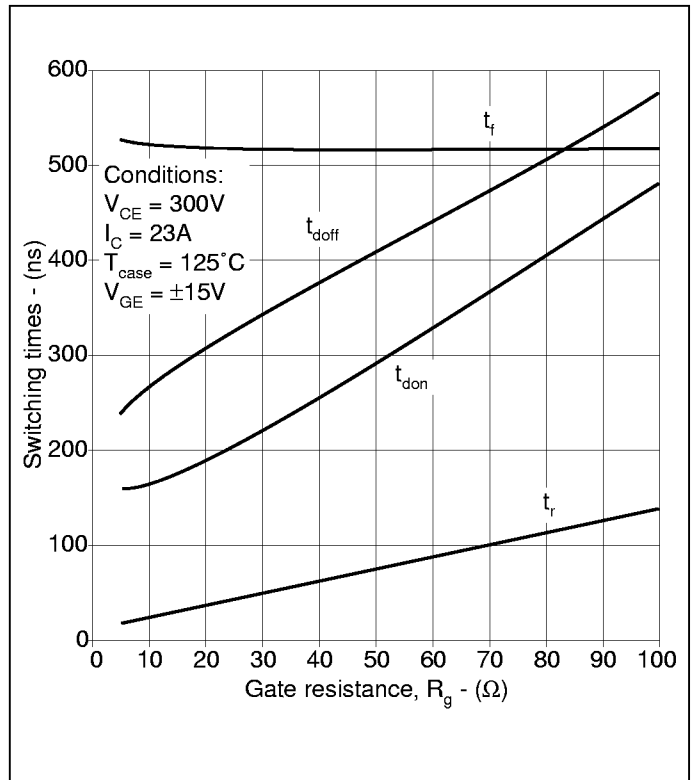

Fig.11 Typical switching times vs gate resistance

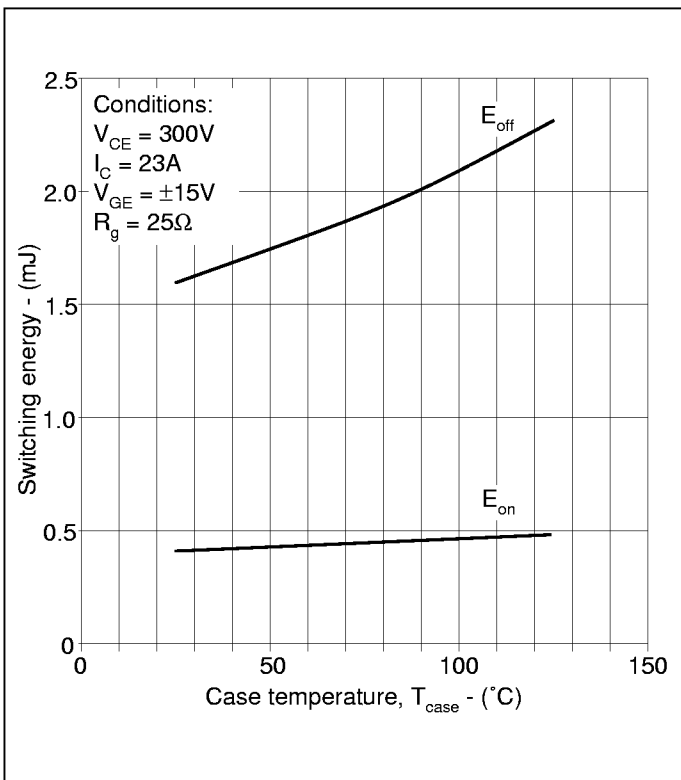

Fig.12 Typical switching losses vs case temperature

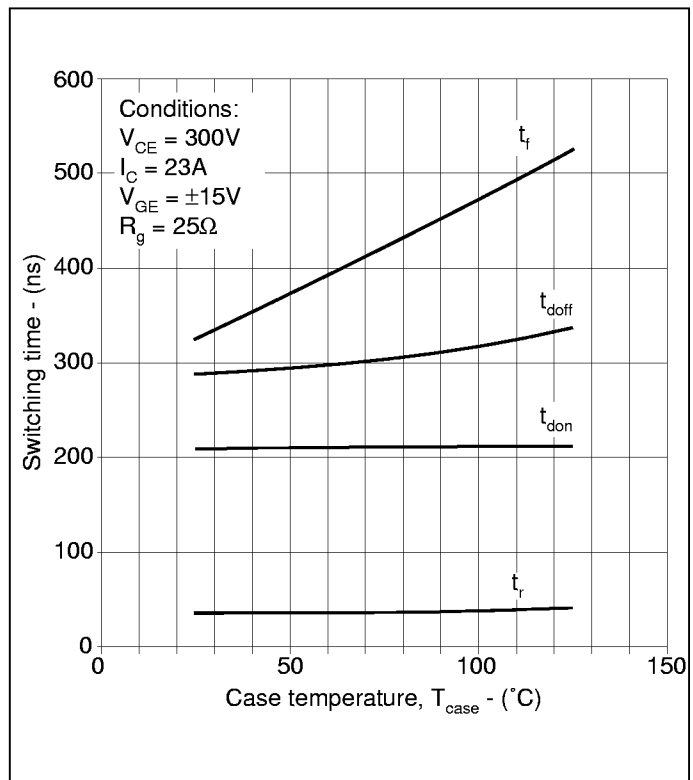

Fig.13 Typical switching times vs case temperature

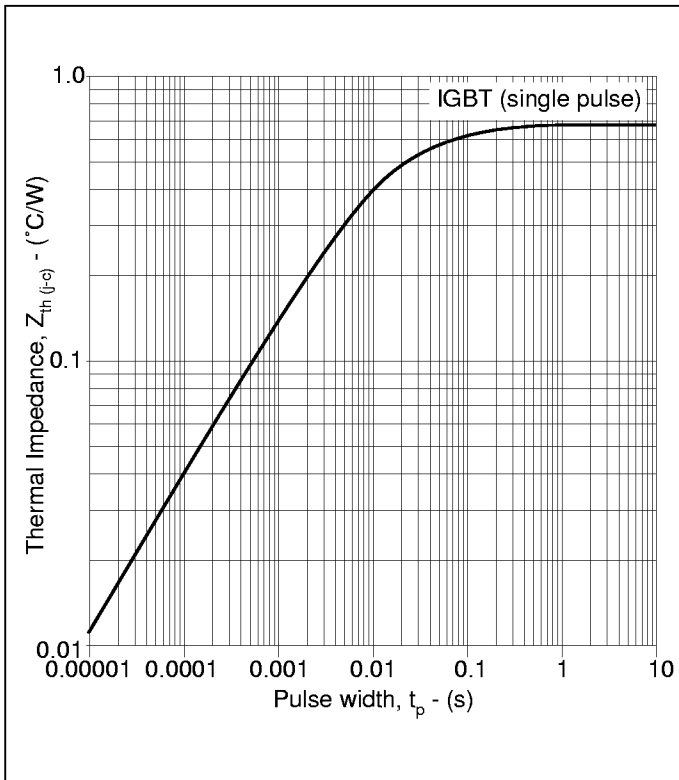

Fig.14 Transient thermal impedance - junction to case

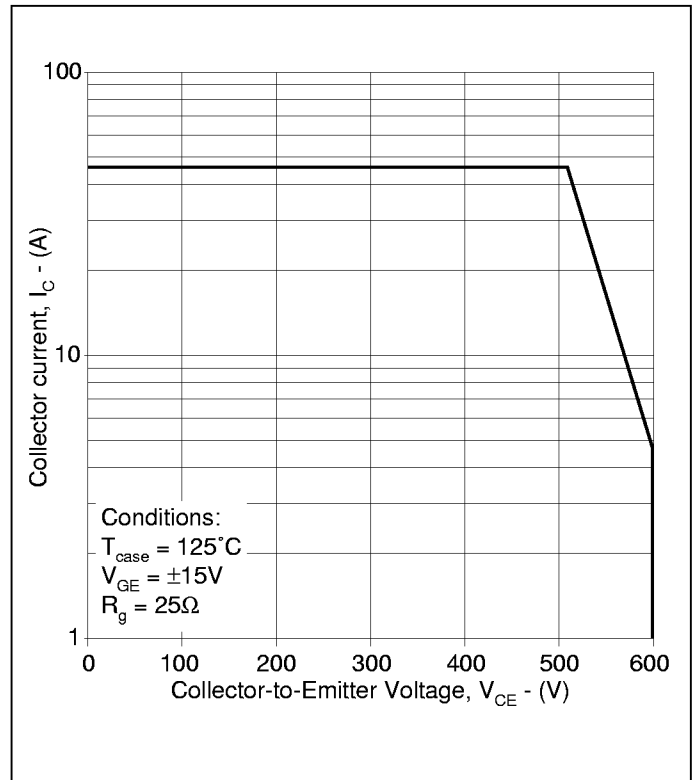
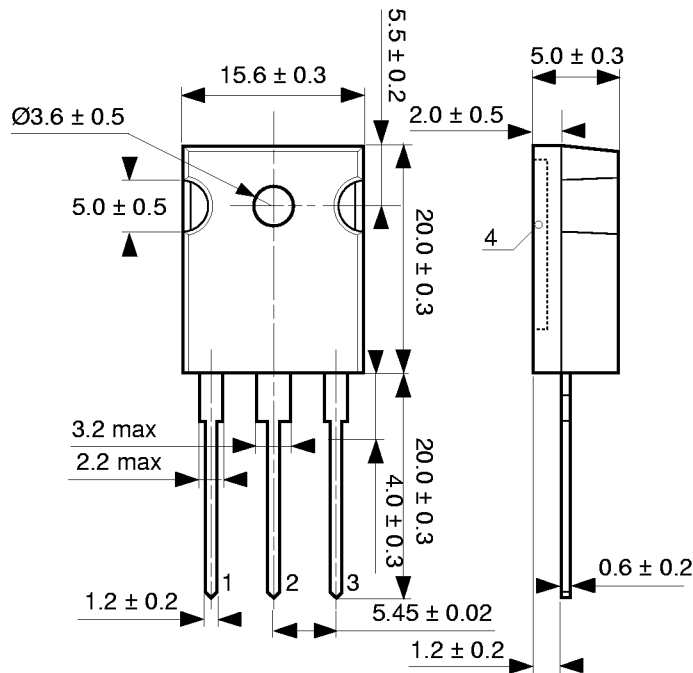

Fig.15 Reverse bias safe operating area

ITS23F06

PACKAGE OUTLINE - TO247

For further package information, please contact your local Customer Service Centre. All dimensions in mm, unless stated otherwise. DO NOT SCALE.



Terminal 1 - Gate
Terminal 2 - Collector
Terminal 3 - Emitter
Terminal 4 - Collector



HEADQUARTERS OPERATIONS
GEC PLESSEY SEMICONDUCTORS
Cheney Manor, Swindon,
Wiltshire, SN2 2QW, United Kingdom.
Tel: + 44 (0)1793 518000
Fax: + 44 (0)1793 518411

GEC PLESSEY SEMICONDUCTORS
P.O. Box 660017
1500 Green Hills Road,
Scotts Valley, California 95066-4922,
United States of America.
Tel: + 1 (408) 438 2900
Fax: + 1 (408) 438 5576/6231

<http://www.gpsemi.com>
POWER PRODUCT CUSTOMER SERVICE CENTRES

- **FRANCE, BENELUX & SPAIN.** 2 rue Henri-Bergson, 92665 Asnieres Cedex.
Tel: + 33 1 40 80 54 00. Fax: + 33 1 40 80 55 87.
- **GERMANY.** Grillparzerstrasse 16, 81675 München.
Tel: + 49 (0)89 41 95 080. Fax: + 49 (0)89 41 95 08 55.
- **NORTH AMERICA.** At Dedham Place, Suite 125, 3 Allied Drive, Dedham. MA 02026.
Tel: + 1 617 251 0126. Fax: + 1 617 251 0106.
- **UNITED KINGDOM.** Doddington Road, Lincoln. LN6 3LF.
Tel: + 44 (0)1522 500500. Fax: + 44 (0)1522 510550.

These are supported by Agents and Distributors in major countries world-wide.

© GEC Plessey Semiconductors 1997 Publication No. DS4713-2 Issue 2.2 September 1997
TECHNICAL DOCUMENTATION - NOT FOR RESALE. PRINTED IN UNITED KINGDOM.

This publication is issued to provide information only which (unless agreed by the Company in writing) may not be used, applied or reproduced for any purpose nor form part of any order or contract nor to be regarded as a representation relating to the products or services concerned. No warranty or guarantee express or implied is made regarding the capability, performance or suitability of any product or service. The Company reserves the right to alter without prior notice the specification, design or price of any product or service. Information concerning possible methods of use is provided as a guide only and does not constitute any guarantee that such methods of use will be satisfactory in a specific piece of equipment. It is the user's responsibility to fully determine the performance and suitability of any equipment using such information and to ensure that any publication or data used is up to date and has not been superseded. These products are not suitable for use in any medical products whose failure to perform may result in significant injury or death to the user. All products and materials are sold and services provided subject to the Company's conditions of sale, which are available on request.

All brand names and product names used in this publication are trademarks, registered trademarks or trade names of their respective owners.