

Packaged PIN Diodes

MA4P100 thru 600 Series

V 2.00

Features

- High Power PIN Diodes
- Fast Speed PIN Diodes
- Voltage Ratings to 1500 Volts
- Long Carrier Lifetime Designs
- Wide Variety of Hermetic Packages
- High Reliability for Space/Military Applications

Description

M/A-COM's product line of packaged PIN diodes represents a comprehensive combination of PIN diode electrical characteristics and package outlines. This union of semiconductor and packaging technology gives considerable design flexibility to the PIN diode circuit designer.

The fast switching speed PIN diodes utilize thin I-region silicon dioxide passivated chips that incorporate careful control of semiconductor processing. These diodes achieve consistent performance in control circuit applications. The packaged CERMACHIP PIN diodes employ M/A-COM's unique hard glass passivated, hermetically sealed PIN diode chip. The packaged CERMACHIP PIN diodes are designed for use in high power and high RF voltage applications. The PIN diode chips are bonded into hermetically sealed ceramic or glass packages that are designed for high volume, close tolerance utilization. Packages are available which are suitable for mounting in a variety of microwave and RF circuit media.

The packaged silicon PIN diode series has high inherent reliability and is capable of meeting stringent environmental tests. These diodes may be ordered with testing to selected reliability levels.

Ordering Information

Packaged PIN diode specifications are listed in the appropriate tables. The standard package style is indicated as part of the model number; i.e., MA4P506-30. Alternative package styles for the diodes are also indicated. To order, indicate the desired model number by indicating the chip model number and desired package style; i.e.,

MA4P506-258. Note that the specification tables lists total diode capacitance in the standard case style only. The total capacitance for the diode in an alternative package are computed from the difference in package capacitance. Parts are available only in the case styles as indicated in each product table.

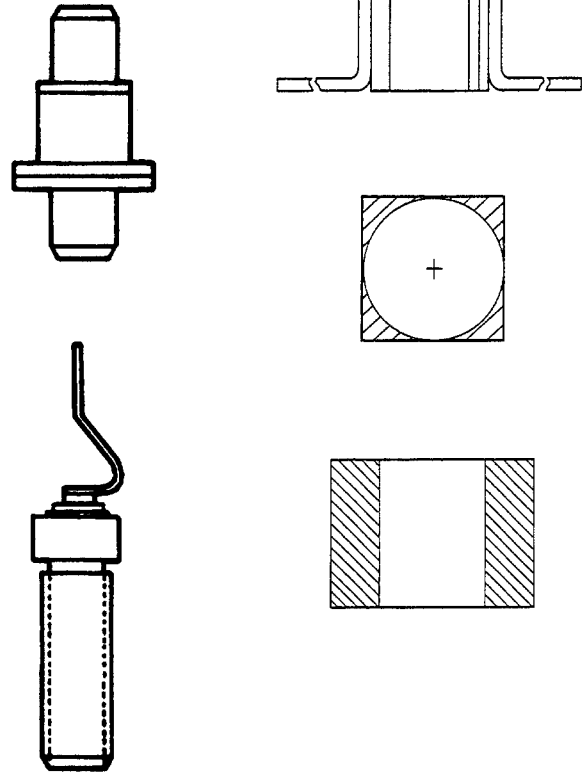

CERMACHIP is a trademark of M/A-COM, Inc.

Specifications Subject to Change Without Notice.

3-48

M/A-COM, Inc.

North America: Tel. (800) 366-2266
Fax (800) 618-8883

■ Asia/Pacific: Tel. +81 (03) 3226-1671
Fax +81 (03) 3226-1451

■ Europe: Tel. +44 (1344) 869 595
Fax +44 (1344) 300 020

50 to 250 Volt, Fast Switching PIN Diodes
Specifications $T_A = +25^\circ\text{C}$

Model ¹ Number	Minimum ² Reverse Voltage V_R (Volts)	Maximum ³ Capacitance C_T @ 10V (pF)	Maximum ⁴ R_S @ 10 mA 500 MHz (ohms)	Maximum Thermal Resistance ($^\circ\text{C}/\text{W}$)	Nominal Characteristics		
					Carrier ⁵ Lifetime (ns)	T_{rr} ⁶ (ns)	I-Region Width (microns)
MA4P102-30	50	0.30	2.0	60	20	3	7
MA4P202-30	100	0.25	2.5	60	60	5	12
MA4P203-30	100	0.35	1.5	30	100	20	12
MA4P303-30	200	0.35	1.5	30	200	60	20
MA4P404-30	250	0.40*	0.6**	20	1000	100	30

* At 50 Volts

** At 50mA, 100 MHz

The standard case style is 30. Also available in the following packages:
31, 32, 36, 94, 111, 120, 186, 255, 276, 1056 and 1088. See Appendix for full dimensions and nominal parasitic values.

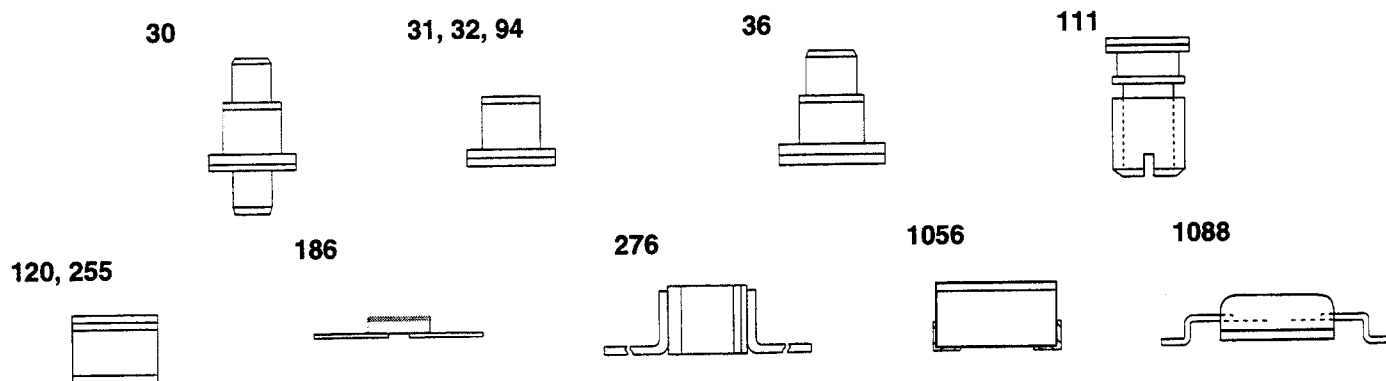

SMQ General Purpose Switching Diodes
Specifications $T_A = +25^\circ\text{C}$

Model Number	Case* Style	Minimum ² Reverse Voltage V_R (Volts)	Maximum Capacitance C_T @ 50V (pF)	Maximum ³ Resistance I_F @ 10 mA (Ohms)	Typical Current for $R_S = 75\Omega$ (mA)	Typical ⁵ Carrier Lifetime (μs)	Typical I-Region Thickness (mils)	Power Dissipation Rating (watts)
MA4PH235	1072	35	1.2	0.5	—	0.3	0.4	1.0
MA4PH236	1072	200	0.5	3.0	—	1.5	2.0	1.0
MA4PH237	1079	200	1.5	0.6	—	3.0	3.0	2.0
MA4PH238	1072	200	0.5	6.0	0.3 - 0.6	2.0	4.0	1.0
MA4PH239	1079	200	0.8	25.0	1.2 - 2.4	6.0	14.0	2.0

*Available only in case styles indicated. See Appendix for full dimensions.

Notes:

1. The diodes are available in chip form for integrated circuits.
2. The maximum reverse current is 10 μA at voltage rating.
3. Capacitance is specified at 1 MHz.
4. Resistance is specified at 100 MHz unless otherwise indicated.
5. Nominal carrier lifetime is specified at 10 mA.

Case Styles 1072, 1079

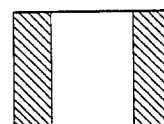

Specifications Subject to Change Without Notice.

MA-COM, Inc.

North America: Tel. (800) 366-2266
Fax (800) 618-8883

Asia/Pacific: Tel. +81 (03) 3226-1671
Fax +81 (03) 3226-1451

Europe: Tel. +44 (1344) 869 595
Fax +44 (1344) 300 020

500 Volt CERMACHIP PIN Diodes Specifications $T_A = +25^\circ\text{C}$

Model ¹ Number	Minimum ² Reverse Voltage V_R (Volts)	Maximum ³ Capacitance C_T @ 100V (pF)	Maximum ⁴ R_S @ 100 mA (Ohms)	Maximum Thermal Resistance ($^\circ\text{C}/\text{W}$)	Nominal Characteristics	
					Carrier ⁵ Lifetime (μs)	I-Region Width (mils)
MA4P504-30	500	0.40	0.60	20	1.0	2
MA4P505-30	500	0.55	0.45	15	2.0	2
MA4P506-30	500	0.90	0.30	10	3.0	2

The standard case style is 30. Also available in the following packages:

31, 32, 36, 111, 255, 258 (isolated Heatsink), 1056, 1088. See Appendix for full dimensions and nominal parasitic values.

30

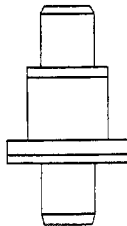

31

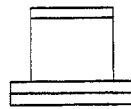

36

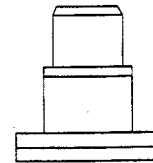

111

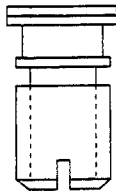

255

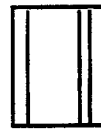

258

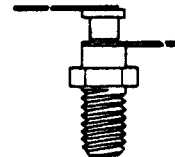

SMQ CERMACHIP High Voltage PIN Diodes Specifications $T_A = +25^\circ\text{C}$

Model Number	Case* Style	Minimum ² Reverse Voltage V_R (Volts)	Maximum ³ Capacitance C_T @ $V_R = 100\text{ V}$ (pF)	Maximum ⁴ R_S @ 100 mA (Ohms)	Typical ⁵ Carrier Lifetime (μs)	Typical I-Region Thickness (mils)	Power Dissipation Rating (Watts)
MA4P504-1072	1072	500	0.5	0.6	1.0	2.0	1.5
MA4P505-1072	1072	500	0.65	0.45	2.0	2.0	1.5
MA4P506-1072	1072	500	1.0	0.3	3.0	2.0	1.5

*See Appendix for full dimensions.

Notes:

- The diodes are available in chip form for integrated circuits.
- The maximum reverse current is 10 μA at voltage rating.
- Capacitance is specified at 1 MHz.
- Resistance is specified at 100 MHz unless otherwise indicated.
- Nominal carrier lifetime is specified at 10 mA.

1072

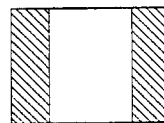

Specifications Subject to Change Without Notice.

3-50

M/A-COM, Inc.

North America: Tel. (800) 366-2266
Fax (800) 618-8883

■ Asia/Pacific: Tel. +81 (03) 3226-1671
Fax +81 (03) 3226-1451

■ Europe: Tel. +44 (1344) 869 595
Fax +44 (1344) 300 020

1000 Volt CERMACHIP PIN Diodes Specifications $T_A = +25^\circ\text{C}$

Model ¹ Number	Minimum ² Reverse Voltage V_R (Volts)	Maximum ³ Capacitance C_T @ 100V (pF)	Maximum ⁴ R_S @ Forward Current (Ohms)	Maximum Thermal Resistance ($^\circ\text{C/W}$)	Nominal Characteristics	
					Carrier ⁵ Lifetime (μs)	I-Region Width (mils)
MA4P604-30	1000	0.50	1.00 @ 100	20	3.0	4
MA4P606-30	1000	0.80	0.70 @ 100	10	4.0	4
MA4P607	1000	2.00	0.40 @ 100	7	5.0	4
MA4P608-43	1000	3.20	0.35 @ 150	5	5.0	4

The standard case styles are indicated as a suffix to the model number. See Appendix for full dimensions.

The MA4P604 and MA4P606 are available only in case style 30.

The MA4P607 is available only in case styles 43 and 296. Add case style suffix to model number.

The MA4P608 is available only in case style 43.

30, 296

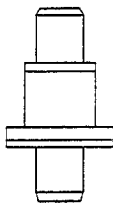

43

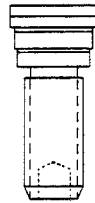

1500 Volt CERMACHIP PIN Diode Specifications $T_A = +25^\circ\text{C}$

Model Number	Minimum ² Reverse Voltage V_R (Volts)	Maximum ³ Capacitance C_T @ 100V (pF)	Maximum ⁴ R_S @ Forward Current (Ohms)	Maximum Thermal Resistance ($^\circ\text{C/W}$)	Nominal Characteristics	
					Carrier ⁵ Lifetime (μs)	I-Region Width (mils)
MA4P709-150	1500	3.3	0.25 @ 200	2	10	7

The standard case style is 150. Also available in 985 (Isolated heatsink). See Appendix for full dimensions.

150



985

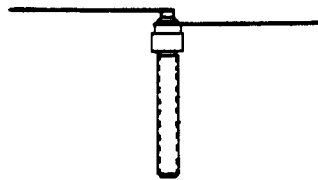

Notes:

1. The diodes are available in chip form for integrated circuits.
2. The maximum reverse current is 10 μA at voltage rating.
3. Capacitance is specified at 1 MHz.
4. Resistance is specified at 100 MHz unless otherwise indicated.
5. Nominal carrier lifetime is specified at 10 mA.

Specifications Subject to Change Without Notice.

M/A-COM, Inc.

3-51

North America: Tel. (800) 366-2266
Fax (800) 618-8883

■ Asia/Pacific: Tel. +81 (03) 3226-1671
Fax +81 (03) 3226-1451

■ Europe: Tel. +44 (1344) 869 595
Fax +44 (1344) 300 020

Maximum Ratings

Parameter	Absolution Max.
Voltage	Voltage Rating
Operating Temperature	- 65°C to +175°C
Storage Temperature	- 65°C to +200°C
Operating & Storage Temp. Case Sty. 1088 (Plastic)	- 65°C to +125°C

Power Dissipation

Cathode Heat Sunked Packages (Case Styles 30, 31, 32, 36, 94, 111, 120, 150, 258, 985, 1072, 1079)	$P_{diss} = \frac{T_{(max. operating)} - 25^{\circ}C}{\text{Thermal Resistance}}$
Leaded Packages @ +25°C (Case Styles 186, 276, 1088)	$P_{diss} = 250mW$
Surface Mount Package (Case Style 1056)	$P_{diss} = 300mW$

Environmental Ratings**Per MIL-STD 750**

The following table is recommended for Group B and C testing for TX, TXV level screening.

	Method	Level
Storage Temperature	1031	See maximum ratings
Operating Temperature	—	See maximum ratings
Temperature Cycling	1051	5 cycles -65° to + 150°C
Shock	2016	500 g's
Vibration	2056	15 g's
Constant Acceleration	2006	20,000 g's
Humidity	1021	10 days

Maximum Soldering Temperature

Case Style 150, 186, 258, 985, 188: 200°C maximum for 5 seconds.

Case Style 120, 255, 276: 200°C maximum for 5 seconds — cathode only.

Case Style 30, 31, 32, 36, 43, 94, 111, 296: 225°C maximum for 5 seconds.

Case Style 1088: 150°C maximum for 5 seconds, 1mm from the case.

Screened Diodes (MIL-STD 750)

Suggested 100% preconditioning and screening program for TX level and TXV level screening.

Inspection	Method	Condition
Internal Visual and/or Xray	2072/2076	See note
High Temp. Storage	1032	48 hours minimum @ max. storage temp.
Thermal Shock	1051	10 Cycles
Constant Acceleration	2006	20,000 g's, Y1
Fine Leak	1071	H
Gross Leak	1071	C or E
Electrical	—	See note
Burn-In	1038	See note

Note:

Conditions and details of test depend on specific model number. Information available upon request. The case styles 1056 and 1088 are not military (MIL-STD-750 rated packages).

Specifications Subject to Change Without Notice.

Typical Resistance Curves

FORWARD CURRENT vs SERIES RESISTANCE
(MA4P202, MA4P203, MA4P303, MA4P404 AND MA4P102)

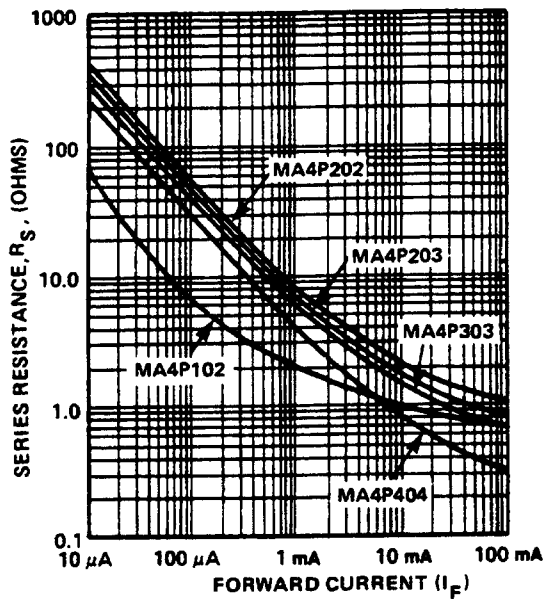

FORWARD CURRENT vs SERIES RESISTANCE
(MA4P504, MA4P505, MA4P506)

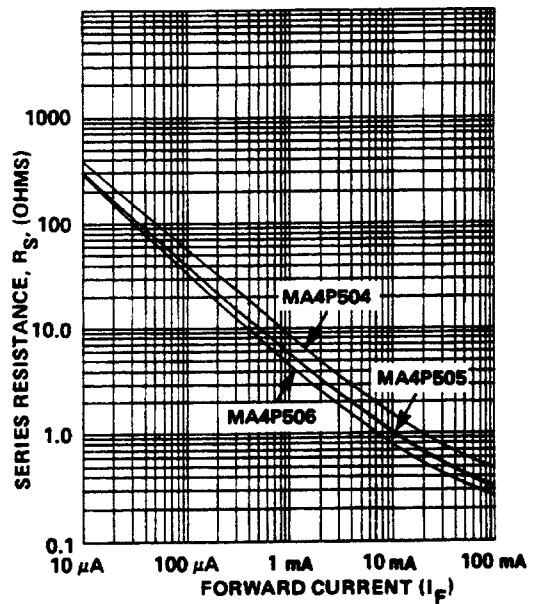

FORWARD CURRENT vs SERIES RESISTANCE
(MA4P604, MA4P606, MA4P607, MA4P608)

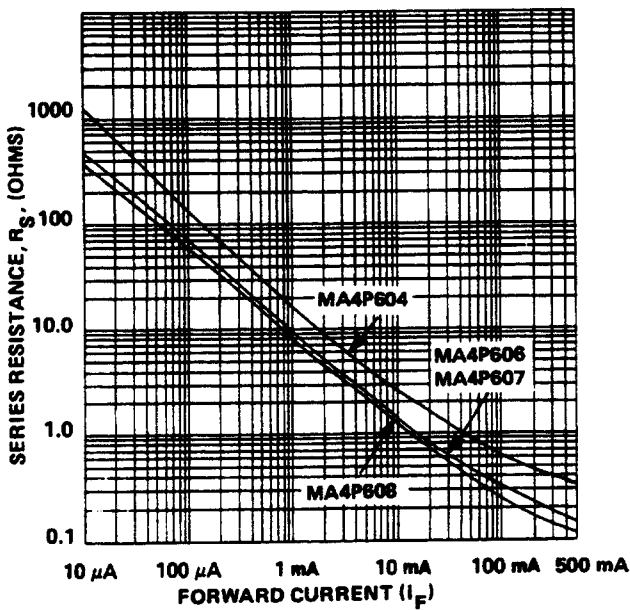

FORWARD CURRENT vs SERIES RESISTANCE
(MA4P709, MA4P902)

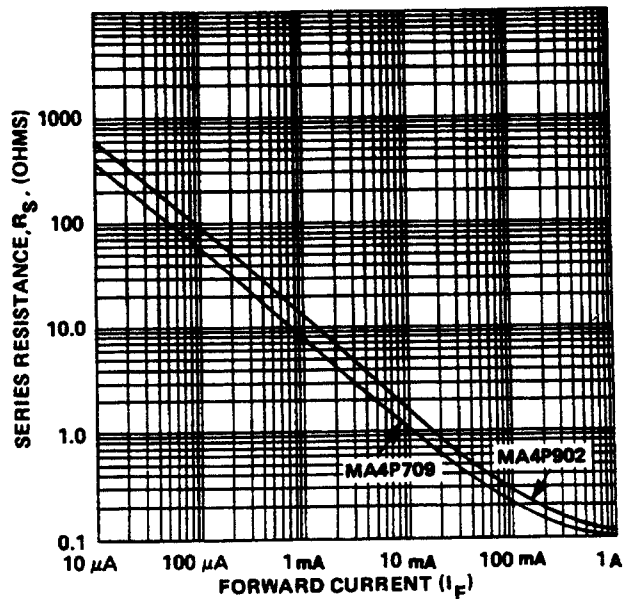

Specifications Subject to Change Without Notice.

MA-COM, Inc.

North America: Tel. (800) 366-2266
Fax (800) 618-8883

■ Asia/Pacific: Tel. +81 (03) 3226-1671
Fax +81 (03) 3226-1451

■ Europe: Tel. +44 (1344) 869 595
Fax +44 (1344) 300 020