

Enhanced High Power Factor Preregulator

FEATURES

- Controls Boost PWM to Near Unity Power Factor
- Limits Line Current Distortion To <3%
- World-Wide Operation Without Switches
- Accurate Power Limiting
- Fixed Frequency Average Current Mode Control
- High Bandwidth (5MHz), Low Offset Current Amplifier
- Integrated Current and Voltage Amp Output Clamps
- Multiplier Improvements: Linearity, 500mV VAC Offset (eliminates external resistor), 0-5V Multout Common Mode Range
- VREF "GOOD" Comparator
- Faster and Improved Accuracy ENABLE Comparator
- UVLO Threshold Options (16/10V / 10.5/10V)
- 300µA Startup Supply Current

DESCRIPTION

The UC1854A/B products are pin compatible enhanced versions of the UC1854. Like the UC1854, these products provide all of the functions necessary for active power factor corrected preregulators. The controller achieves near unity power factor by shaping the AC input line current waveform to correspond to the AC input line voltage. To do this the UC1854A/B uses average current mode control. Average current mode control maintains stable, low distortion sinusoidal line current without the need for slope compensation, unlike peak current mode control.

The UC1854A/B products improve upon the UC1854 by offering a wide bandwidth, low offset Current Amplifier, a faster responding and improved accuracy enable comparator, a VREF "good" comparator, UVLO threshold options (16/10V for offline, 10.5/10V for startup from an auxiliary 12V regulator), lower startup supply current, and an enhanced multiply/divide circuit. New features like the amplifier output clamps, improved amplifier current sinking capability, and low offset VAC pin reduce the external component count while improving performance. Improved common mode input range of the Multiplier output/Current Amp input allow the designer greater flexibility in choosing a method for current sensing. Unlike its predecessor, RSET controls only oscillator charging current and has no effect on clamping the maximum multiplier output current. This current is now clamped to a maximum of $2 \cdot I_{AC}$ at all times which simplifies the design process and provides foldback power limiting during brownout and extreme low line conditions.

A 1% 7.5V reference, fixed frequency oscillator, PWM, Voltage Amplifier with softstart, line voltage feedforward (V_{RMS} squarer), input supply voltage clamp, and over current comparator round out the list of features.

	UVLO Turn on	UVLO Turn off
UC1854A	16V	10V
UC1854B	10.5V	10V

BLOCK DIAGRAM

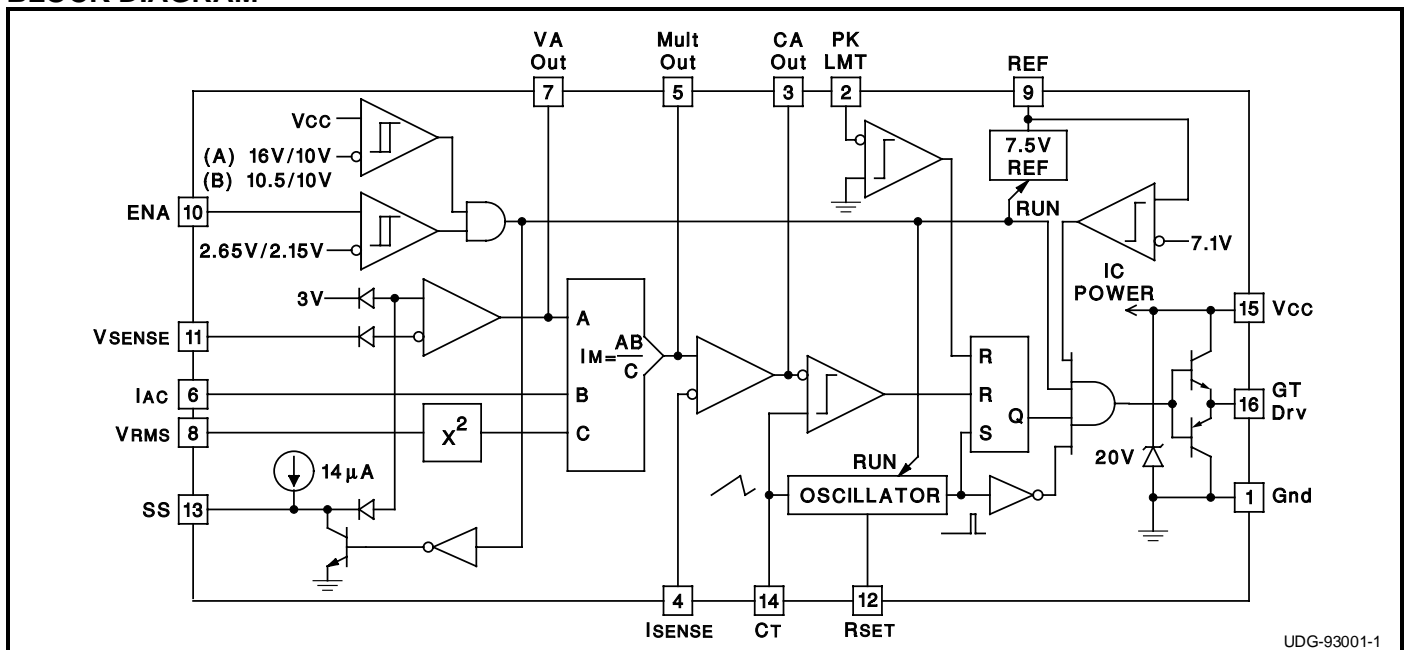

ABSOLUTE MAXIMUM RATINGS

Supply Voltage Vcc	22V
GT Drv Current, Continuous	0.5A
GT Drv Current, 50% Duty Cycle	1.5A
Input Voltage, VSENSE, VRMS	11V
Input Voltage, ISENSE, Mult Out	11V
Input Voltage, PKLMT	5V
Input Current, RSET, IAC, PKLMT, ENA	10mA
Power Dissipation	1W
Storage Temperature	-65°C to +150°C
Lead Temperature (Soldering, 10 Seconds)	+300°C

Note 1: All voltages with respect to Gnd (Pin 1).

Note 2: All currents are positive into the specified terminal.

Note 3: ENA input is internally clamped to approximately 10V.

Note 4: Consult Unimicro Integrated Circuits databook for information regarding thermal specifications and limitations of packages.

CONNECTION DIAGRAMS

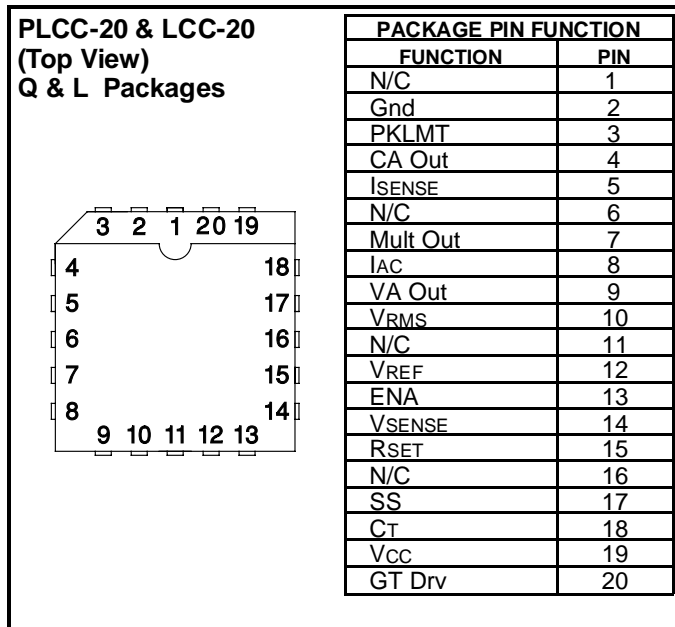
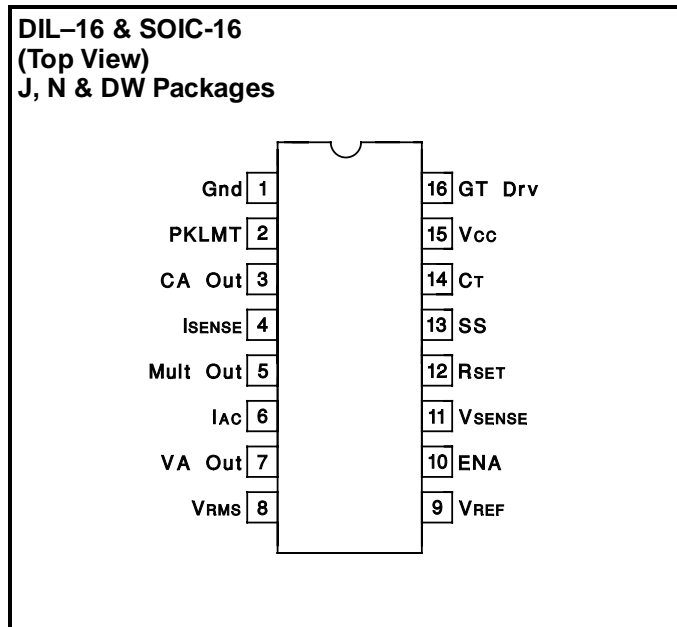

ELECTRICAL CHARACTERISTICS Unless otherwise stated, Vcc=18V, RT=8.2k, CT=1.5nF, PKLMT=1V, VRMS=1.5V, IAC=100µA, ISENSE=0V, CA Out=3.5V, VA Out=5V, VSENSE=3V, -55°C<TA<125°C for the UC1854A/B, -40°C<TA<85°C for the UC2854A/B, and 0°C<TA<70°C for the UC3854A/B, and TA=TJ.

PARAMETER	TEST CONDITIONS	MIN	TYP	MAX	UNITS
OVERALL					
Supply Current, Off	CAO, VAO = 0V, Vcc = UVLO - 0.3V		250	400	µA
Supply Current, On			12	18	mA
Vcc Turn-On Threshold	UC1854A		16	17.5	V
	UC1854B		10.5	11.2	V
Vcc Turn-Off Threshold	UC1854A / B	9	10		V
Vcc Clamp	I(Vcc) = Icc(on) + 5mA	18	20	22	V
VOLTAGE AMPLIFIER					
Input Voltage		2.9	3.0	3.1	V
VSENSE Bias Current		-500	-25	500	nA
Open Loop Gain	VOUT = 2 to 5V	70	100		dB
VOUT High	ILOAD = -500µA		6		V
VOUT Low	ILOAD = 500µA		0.3	0.5	V
Output Short Circuit Current	VOUT = 0V		1.5	3.5	mA
Gain Bandwidth Product	Fin = 100kHz, 10mV p-p, (Note 1)		1		mHz

ELECTRICAL CHARACTERISTICS (cont.)

Unless otherwise stated, V_{CC}=18V, R_T=8.2k, C_T=1.5nF, PKLMT=1V, V_{RMS}=1.5V, I_{AC}=100μA, I_{SENSE}=0V, CA Out=3.5V, VA Out=5V, V_{SENSE}=3V, -55°C<T_A<125°C for the UC1854A/B, -40°C<T_A<85°C for the UC2854A/B, and 0°C<T_A<70°C for the UC3854A/B, and T_A=T_J.

PARAMETER	TEST CONDITIONS	MIN	TYP	MAX	UNITS
CURRENT AMPLIFIER					
Input Offset Voltage	V _{CM} = 0V T _A = +25°C	-4		0	mV
		OverTemp	-5.5		0
Input Bias Current(sense)	V _{CM} = 0V	-500		500	nA
Open Loop Gain	V _{CM} = 0V, V _{OUT} = 2 to 6V	80	110		dB
V _{OUT} High	I _{LOAD} = -500μA		8		V
V _{OUT} Low	I _{LOAD} = 500μA		0.3	0.5	V
Output Short Circuit Current	V _{OUT} = 0V		1.5	3.5	mA
Common Mode Range		-0.3		5	V
Gain Bandwidth Product	f _{in} = 100kHz, 10mV p-p, (Note 1)	3	5		mHz
REFERENCE					
Output Voltage	I _{REF} = 0mA, T _A = 25°C	7.4	7.5	7.6	V
	I _{REF} = 0mA	7.35	7.5	7.65	V
Load Regulation	I _{REF} = 1 to 10mA	0	8	20	mV
Line Regulation	V _{CC} = 12 to 18V	0	14	25	mV
Short Circuit Current	V _{REF} = 0V	25	35	60	mA
OSCILLATOR					
Initial Accuracy	T _A = 25°C	85	100	115	kHz
Voltage Stability	V _{CC} = 12 to 18V		1		%
Total Variation	Line, Temp	80		120	kHz
Ramp Amplitude (p-p)		4.9		5.9	V
Ramp Valley Voltage		0.8		1.3	V
ENABLE / SOFTSTART / CURRENT LIMIT					
Enable Threshold		2.35	2.55	2.8	V
Enable Hysteresis	V _{FAULT} = 2.5V		500	600	mV
Enable Input Bias Current	V _{ENABLE} = 0V		-2	-5	μA
Propagation Delay to Disable	Enable Overdrive = -100mV,(Note 1)		300		ns
SS Charge Current	V _{SOFTSTART} = 2.5V	10	14	24	
PKLMT Offset Voltage		-15		15	mV
PKLMT Input Current	V _{PKLMT} = -0.1V	-200	-100		μA
PKLMT Propagation Delay	(Note 1)		150		ns
MULTIPLIER					
Output Current - I _{AC} Limited	I _{AC} =100μA, V _{RMS} = 1V, R _{SET} = 10k	-220	-200	-170	μA
Output Current - Zero	I _{AC} =0μA, R _{SET} = 10k	-2.0	-0.2	2.0	μA
Output Current - Power Limited	V _{RMS} = 1.5V, V _a = 6V	-230	-200	-170	μA
Output Current	V _{RMS} = 1.5V, V _a = 2V		-22		μA
	V _{RMS} = 1.5V, V _a = 5V		-156		μA
	V _{RMS} = 5V, V _a = 2V		-2		μA
	V _{RMS} = 5V, V _a = 5V		-14		μA
Gain Constant	(Note 2) V _{RMS} = 1.5V, T _J = 25°C, V _a = 6V	-1.1	-1.0	-0.9	A/A

Note 1: Guaranteed by design, not 100% tested in production.

Note 2: Gain constant (K) = $\frac{I_{AC} \times (V_a - 1.5V)}{V_{RMS}^2 \times I_{MO}}$

ELECTRICAL CHARACTERISTICS (cont.)

Unless otherwise stated, VCC=18V, RT=8.2k, CT=1.5nF, PKLMT=1V, VRMS=1.5V, IAC=100µA, ISENSE=0V, CA Out=3.5V, VA Out=5V, VSENSE=3V, -55°C<TA<125°C for the UC1854A/B, -40°C<TA<85°C for the UC2854A/B, and 0°C<TA<70°C for the UC3854A/B, and TA=TJ.

PARAMETER	TEST CONDITIONS	MIN	TYP	MAX	UNITS
GATE DRIVER					
Output High Voltage	IOUT = -200mA, VCC = 15V	12	12.8		V
Output Low Voltage	IOUT = 200mA		1	2.2	V
	IOUT = 10mA		300	500	mV
Output Low (UVLO)	IOUT = 50mA, VCC = 0V		0.9	1.5	V
Output Rise / Fall Time	CLOAD = 1nF, (Note 1)		35		ns
Output Peak Current	CLOAD = 10nF, (Note 1)		1.0		A

Note 1: Guaranteed by design, not 100% tested in production.

Note 2: Gain constant (K) = $\frac{IAC \times (Va - 1.5V)}{VRMS^2 \times IMO}$

FUNCTIONAL DESCRIPTION

The UC1854A/B products were designed as pin compatible upgrades to the industry standard UC1854 active Power Factor correction circuits. The circuit enhancements allow the user to eliminate in most cases several external components currently required to successfully apply the UC1854. In addition, linearity improvements to the Multiply, Square, and Divide circuitry optimizes overall system performance. Detailed descriptions of the circuit enhancements are provided below. For in-depth design applications reference data refer to Unitrode application notes U-134 and DN-44.

MULTIPLY / SQUARE AND DIVIDE

The UC1854A/B Multiplier design maintains the same gain constant (K = -1), as the UC1854. The relationship between the inputs and output current is given as:

$$IMO = IAC(VAO - 1.5V) / K \cdot VRMS^2$$

This is nearly the same as the UC1854, but circuit differences have improved the performance and application.

The first difference is with the IAC input. The UC1854A/B regulates this pin voltage to a nominal 500mV over the full operating temperature range, rather than the 6.0V used on the UC1854. This low offset voltage eliminates the need for a line zero crossing compensating resistor to VREF from IAC that UC1854 designs require. The maximum current at high line into IAC should be limited to 250µA for best performance. Therefore, if VAC (max) = 270V, then RAC = 270(1.414) / 250µA = 1.53MΩ.

The VRMS pin linear operating range is improved with the UC1854A/B as well. The input range for VRMS extends from 0 to 5.5V. Since the UC1854A squaring circuit employs an analog multiplier, rather than a linear approximation, accuracy is improved, and discontinuities are eliminated. The external divider network connected to

VRMS should produce 1.5V at low line (85VAC). This will put 4.77V on VRMS at high line (27VAC) which is well within its operating range.

The Voltage Amplifier output forms the third input to the Multiplier and is internally clamped to 6.0V. This eliminates an external zenerclamp often used in UC1854 designs. The offset voltage at this input to the Multiplier has been raised on the UC1854A/B to 1.5V.

The Multiplier output pin, which is also common to the Current Amplifier non-inverting input, has a -0.3V to 5.0V output range, compared to the -0.3 to 2.5V range of the UC1854. This improvement allows the UC1854A/B to be used in applications where the current sense signal amplitude is very large.

VOLTAGE AMPLIFIER

The UC1854A/B Voltage Amplifier design is essentially similar to the UC1854 with two exceptions. The first is with the internal connection. The lower voltage reduces the amount of charge on the compensation capacitor, which provides improved recovery from large signal events, such as line dropouts, or power interruption. It also minimizes the DC current flowing through the feedback. The output of the Voltage amplifier is also changed. In addition to a 6.0V temperature compensated clamp, the output short circuit current has been lowered to 2mA typical, and an active pull down has replaced the passive pulldown of the UC1854.

CURRENT AMPLIFIER

The Current Amplifier for an average current PFC controller needs a low offset voltage in order to minimize AC line current distortion. With this in mind, the UC1854A/B Current Amplifier has improved the input offset voltage from ±4mV to 0 to -3mV. The negative

FUNCTIONAL DESCRIPTION (cont.)

offset of the UC1854A/B guarantees that the PWM circuit will not drive the MOSFET if the current command is zero (both Current amplifier inputs zero.). Previous designs required an external offset cancellation network to implement this key feature. The bandwidth of the Current Amplifier has been improved as well to 5mHz typical. While this is not generally an issue at 50 or 60Hz inputs, it is essential for 400Hz input avionics applications.

MISCELLANEOUS

Several other important enhancements have been implemented in the UC1854A/B. A V_{CC} supply voltage clamp at 20V allows the controller to be current fed if

desired. The lower startup supply current ($250\mu A$ typical), substantially reduces the power requirements of an offline startup resistor. The 10.5/10V UVLO option (UC1854B) enables the controller to be powered off of an auxiliary 12V supply.

The V_{REF} "GOOD" comparator guarantees that the MOSFET driver output remains low if the supply or the 7.5V reference are not yet up. This improvement eliminates the need for external Schottky diodes on the PKL and CA+ pins that some UC1854 designs require. The propagation delay of the disable feature has been improved to 300ns typical. This delay was proportional to

TYPICAL CHARACTERISTICS at $T_A = T_J = 25^\circ C$

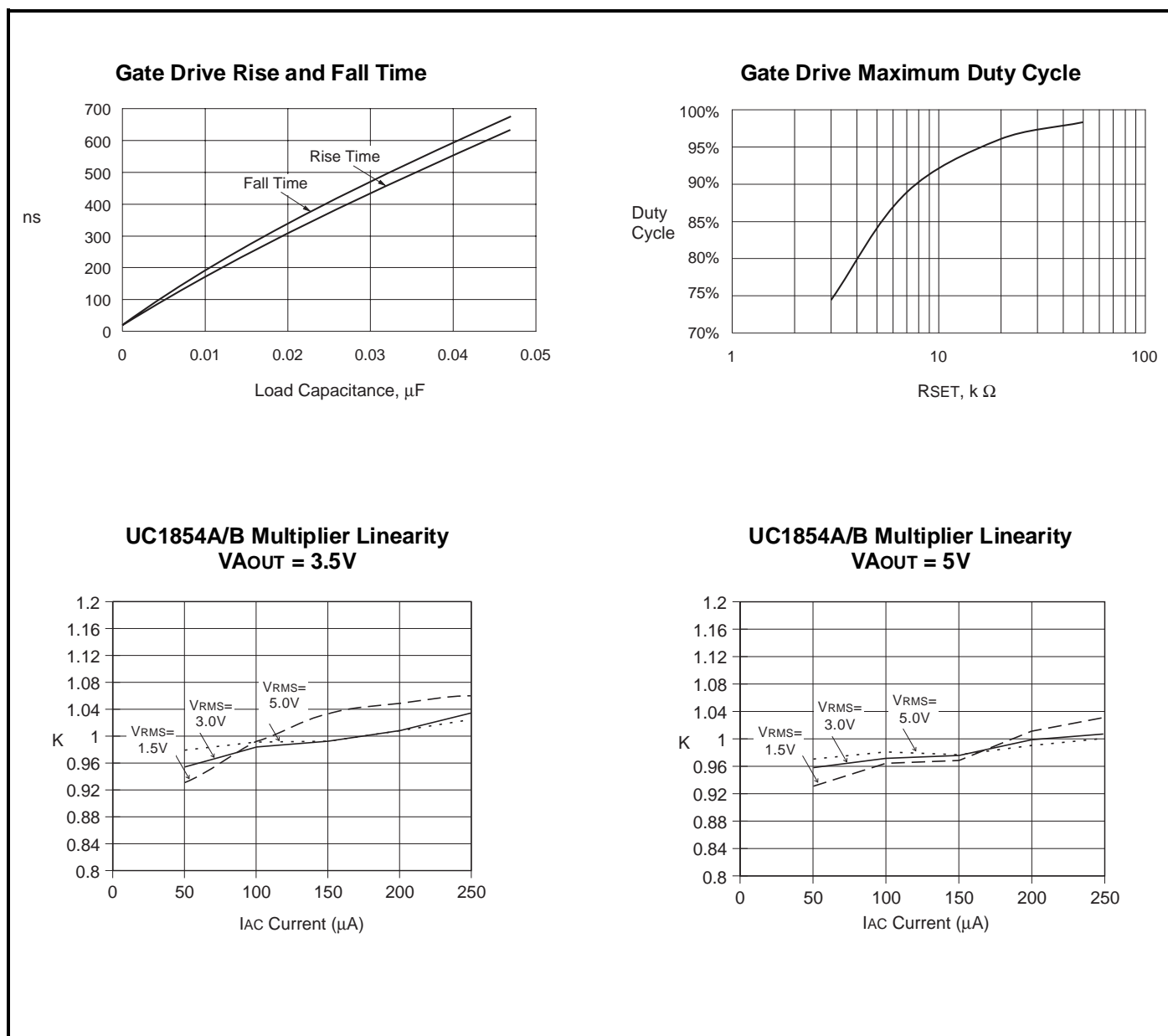

TYPICAL CHARACTERISTICS at TA = TJ = 25°C (cont.)

Current Amplifier Frequency Response

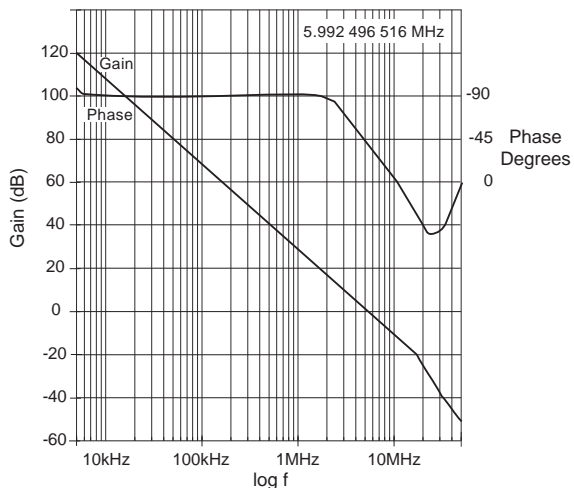

Oscillator Frequency vs RSET and CT

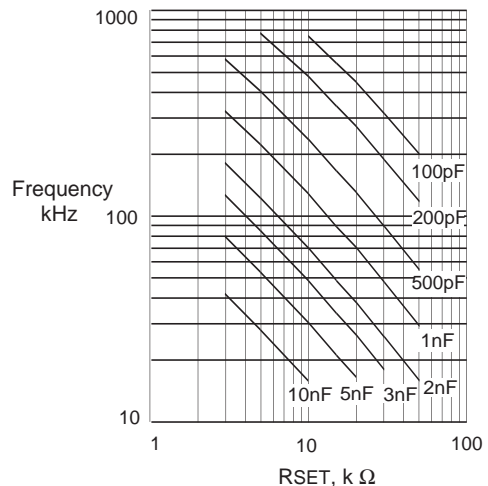

Voltage Amplifier Gain and Phase vs Frequency

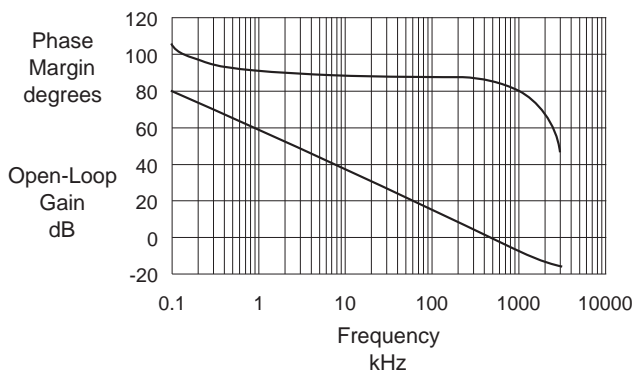

IMPORTANT NOTICE

Texas Instruments and its subsidiaries (TI) reserve the right to make changes to their products or to discontinue any product or service without notice, and advise customers to obtain the latest version of relevant information to verify, before placing orders, that information being relied on is current and complete. All products are sold subject to the terms and conditions of sale supplied at the time of order acknowledgement, including those pertaining to warranty, patent infringement, and limitation of liability.

TI warrants performance of its semiconductor products to the specifications applicable at the time of sale in accordance with TI's standard warranty. Testing and other quality control techniques are utilized to the extent TI deems necessary to support this warranty. Specific testing of all parameters of each device is not necessarily performed, except those mandated by government requirements.

CERTAIN APPLICATIONS USING SEMICONDUCTOR PRODUCTS MAY INVOLVE POTENTIAL RISKS OF DEATH, PERSONAL INJURY, OR SEVERE PROPERTY OR ENVIRONMENTAL DAMAGE ("CRITICAL APPLICATIONS"). TI SEMICONDUCTOR PRODUCTS ARE NOT DESIGNED, AUTHORIZED, OR WARRANTED TO BE SUITABLE FOR USE IN LIFE-SUPPORT DEVICES OR SYSTEMS OR OTHER CRITICAL APPLICATIONS. INCLUSION OF TI PRODUCTS IN SUCH APPLICATIONS IS UNDERSTOOD TO BE FULLY AT THE CUSTOMER'S RISK.

In order to minimize risks associated with the customer's applications, adequate design and operating safeguards must be provided by the customer to minimize inherent or procedural hazards.

TI assumes no liability for applications assistance or customer product design. TI does not warrant or represent that any license, either express or implied, is granted under any patent right, copyright, mask work right, or other intellectual property right of TI covering or relating to any combination, machine, or process in which such semiconductor products or services might be or are used. TI's publication of information regarding any third party's products or services does not constitute TI's approval, warranty or endorsement thereof.