

LUXEON XR-5050 HE

New Form-Factor Compatible with Off-the-Shelf Optics

LUXEON XR-5050 HE products are standard integrated modules compatible with off-the-shelf drivers, optics and heat sinks. They feature LUXEON 5050 HE LEDs and are constructed with MCPCB substrates for thermal efficiency and mechanical robustness, and eliminate engineering design costs, tooling costs, and material inventory costs. This versatile building-block approach simplifies system integration and accelerates time-to-market.



FEATURES AND BENEFITS

Efficacy and Luminous flux of up to 184lm/W typ and 8600lm available

Available CCT/CRI combinations: 70CRI (2200K, 2700K, 3000K, 4000K, 5000K and 5700K), 80CRI (2700K, 3000K, 4000K, 5000K and 5700K) and 90CRI (5700K)

Superior board level color control of ≤ 3 SDCM

MCPCB for efficient heat dissipation and mechanical robustness

UL 8750, ENEC, CE, UKCA compliance

5-year limited guarantee

PRIMARY APPLICATIONS

High Bay

Low Bay

Sport Lights

Outdoor Area Lights

Table of Contents

General Product Information	2
Product Test Conditions	2
Part Number Nomenclature	2
Lumen Maintenance	2
Environmental Compliance	2
Performance Characteristics	3
Product Selection Guide	3
Electrical and Thermal Characteristics	3
Board Level Color Control	3
Absolute Maximum Ratings	4
Application Information	4
Recommended Wire	4
Characteristic Curves	5
Spectral Power Distribution Characteristics	5
Light Output Characteristics	6
Efficacy Characteristics	7
Mechanical Dimensions	8
Packaging Information	9

General Product Information

Product Test Conditions

LUXEON XR-5050 HE modules are tested using a 20ms monopulse (MP) at 1050mA, case temperature Tc of 85°C.

Part Number Nomenclature

Part numbers for LUXEON XR-5050 HE follow the convention below:

L 2 2 5 – A A B B 0 C C M D D 0 1 0

Where:

- A A** – designates nominal ANSI CCT (22=2200K, 27=2700K, 30=3000K, 40=4000K, 50=5000K, 57=5700K)
- B B** – designates minimum CRI (70=70CRI, 80=80CRI and 90=90CRI)
- C C** – designates number of emitters (24=24 emitters)
- D D** – designates internal Lumileds program code
- 1 0** – designates internal Lumileds program code

Therefore, a LUXEON XR-5050 HE 4000K 80CRI with 24 emitters, will have the following part number:

L 2 2 5 – 4 0 8 0 0 2 4 M L U 0 1 0

Lumen Maintenance

Please contact your local Sales Representative or Lumileds Technical Solutions Manager for more information about the long-term performance of this product.

Environmental Compliance

Lumileds LLC is committed to providing environmentally friendly products to the solid-state lighting market. LUXEON XR-5050 HE is compliant to the European Union directives on the restriction of hazardous substances in electronic equipment, namely the ROHS Directive 2011/65/EU including amendments 2015/863/EU & 2017/2102/EU and REACH Regulation (EC) 1907/2006. Lumileds LLC will not intentionally add the following restricted materials to its products: lead, mercury, cadmium, hexavalent chromium, polybrominated biphenyls (PBB) or polybrominated diphenyl ethers (PBDE).

Performance Characteristics

Product Selection Guide

Table 1. Product performance of LUXEON XR-5050 HE at 1050mA, Tc=85°C.

NOMINAL CCT	MINIMUM CRI ^[1, 2]	LUMINOUS FLUX ^[1] (lm)		TYPICAL LUMINOUS EFFICACY (lm/W)	ENERGY EFFICIENCY CLASS ^[3]	PART NUMBER
		MINIMUM	TYPICAL			
2200K	70	6856	7272	155	E	L225-2270024MLU010
2700K	70	7618	8042	171	D	L225-2770024MLU010
3000K	70	7923	8328	177	D	L225-3070024MLU010
4000K	70	8317	8636	184	C	L225-4070024MLU010
5000K	70	8317	8636	184	C	L225-5070024MLU010
5700K	70	8121	8442	179	D	L225-5770024MLU010
2700K	80	6733	7241	154	E	L225-2780024MLU010
3000K	80	7039	7553	161	D	L225-3080024MLU010
4000K	80	7661	8025	171	D	L225-4080024MLU010
5000K	80	7661	8025	171	D	L225-5080024MLU010
5700K	80	7578	7914	168	D	L225-5780024MLU010
5700K	90	6396	6834	145	E	L225-5790024MLU010

Notes for Table 1:

- Lumileds maintains a tolerance of ± 2 on CRI and $\pm 7\%$ on luminous flux measurements.
- Typical CRI is approximately 2 points higher than the minimum CRI specified, but this is not guaranteed.
- Energy efficiency class as specified in Commission Delegated Regulation (EU) 2019/2015. The available range of energy efficiency classes is A-G.

Electrical and Thermal Characteristics

Table 2. Electrical characteristics for LUXEON XR-5050 HE at 1050mA, Tc=85°C.

PART NUMBER	FORWARD VOLTAGE ^[1] (V _f)		
	MINIMUM	TYPICAL	MAXIMUM
L225-xxxx024MLU010	42.0	44.8	45.2

Notes for Table 2:

- Lumileds maintains a tolerance of $\pm 0.1V$ on forward voltage measurements.

Board Level Color Control

Table 3. Board Level Color Control for LUXEON XR-5050 HE.

PART NUMBER	COLOR CONTROL
L225-xxxx024MLU010	3SDCM

Absolute Maximum Ratings

Table 4. Absolute maximum ratings for LUXEON XR-5050 HE.

PARAMETER	MAXIMUM PERFORMANCE
DC Forward Current ^[1, 2]	2000mA
Peak Pulsed Forward Current ^[1, 3]	4000mA
Maximum Working Voltage ^[4]	250Vdc
ESD Sensitivity (ANSI/ESDA/JEDEC JS-001-2012)	Class 2
Operating Case Temperature at Tc point ^[1]	-40 to 85°C
LED Storage Temperature	-40°C to 105°C
Reverse Voltage ($V_{reverse}$)	LUXEON LEDs are not designed to be driven in reverse bias

Notes for Table 4:

- Proper current derating must be observed to maintain the Tc temperature below the maximum allowable Tc temperature.
- Residual periodic variations due to power conversion from alternating current (AC) to direct current (DC), also called "ripple," are acceptable if the following conditions are met:
 - The frequency of the ripple current is 100Hz or higher
 - The average current for each cycle does not exceed the maximum allowable DC forward current
 - The maximum amplitude of the ripple does not exceed the maximum peak pulsed forward current
- At <=50% duty cycle with pulse width of 5ms.
- Basic insulation between live parts on the LED module and mounting surface or touchable parts when mounted in a luminaire for SELV and other than SELV operations has been evaluated according to IEC 62031.

Application Information

Table 5. Approbation for LUXEON XR-5050 HE.

ITEM	COMPLIANT TO
Test and Certification	CE
	UKCA
	ENEC
	UL8750 (UL file no. E335118)
Declaration	RoHS
	REACH

Recommended Wire

Table 6. Recommended Wire for LUXEON XR-5050 HE.

RECOMMENDED WIRE	INSULATOR DIAMETER	STRIP LENGTH
AWG 26-18	Maximum 2.5mm	4mm to 5mm

Characteristic Curves

Spectral Power Distribution Characteristics

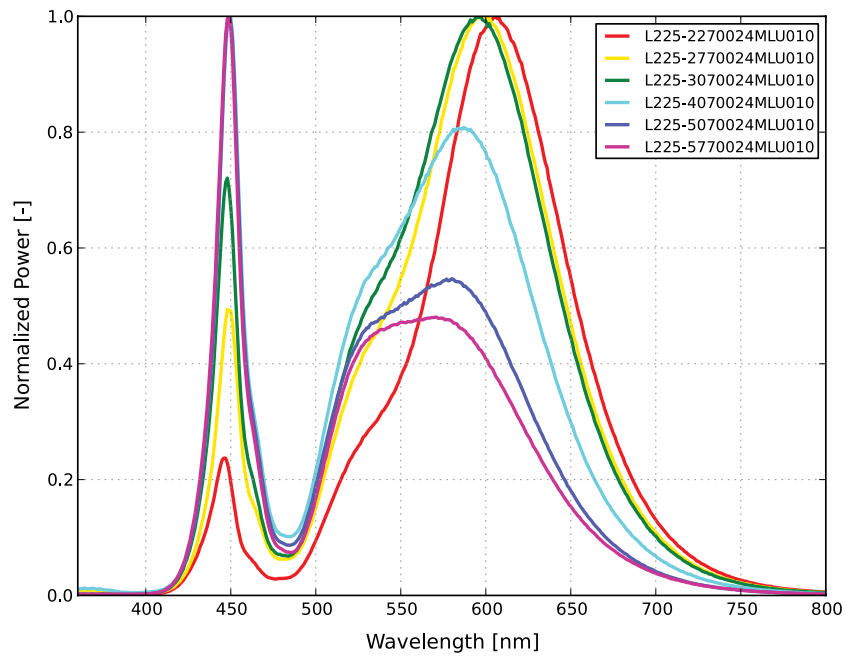

Figure 1. Typical normalized power vs. wavelength for 70CRI LUXEON XR-5050 HE at 1050mA, Tc=25°C.

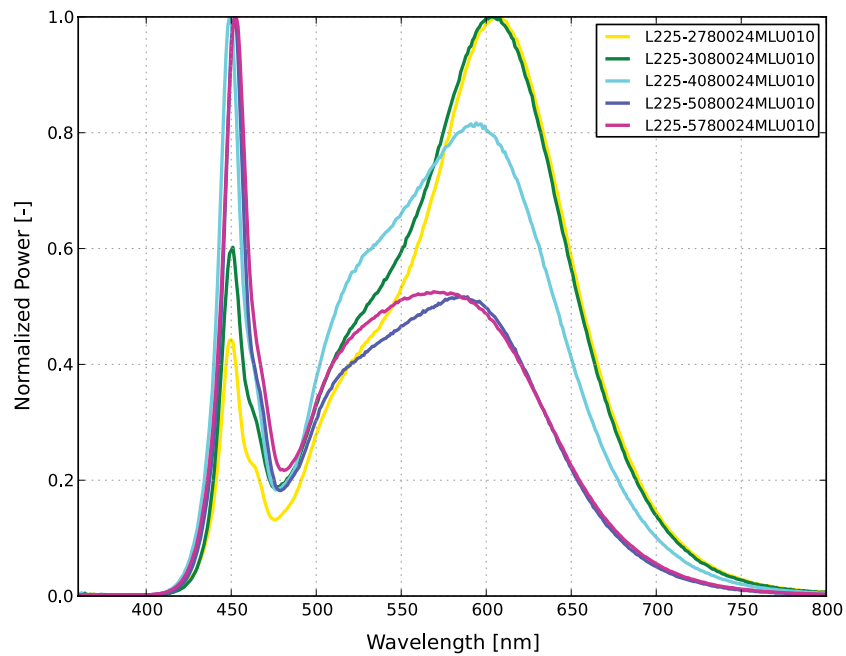

Figure 2. Typical normalized power vs. wavelength for 80CRI LUXEON XR-5050 HE at 1050mA, Tc=25°C.

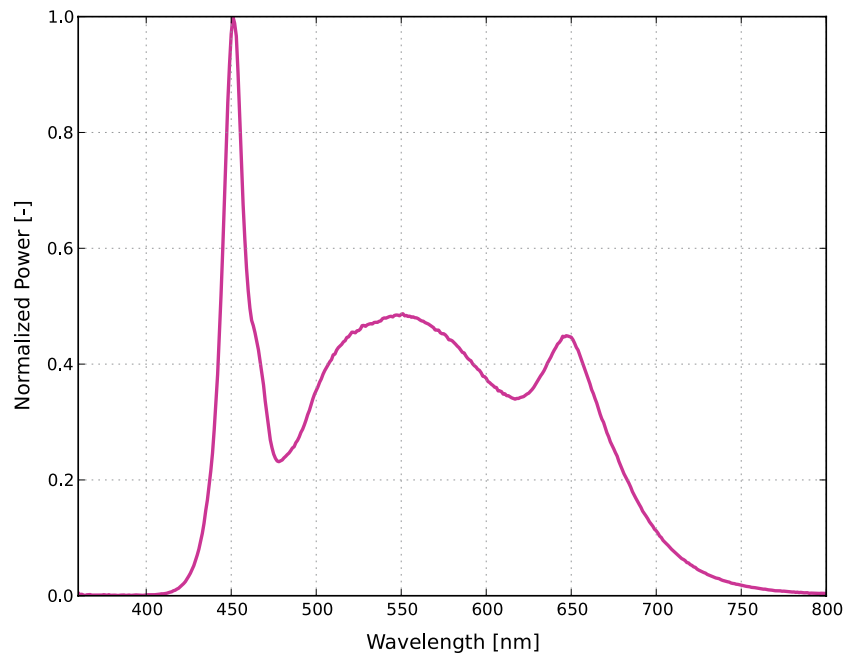

Figure 3. Typical normalized power vs. wavelength for 90CRI LUXEON XR-5050 HE at 1050mA, Tc=25°C.

Light Output Characteristics

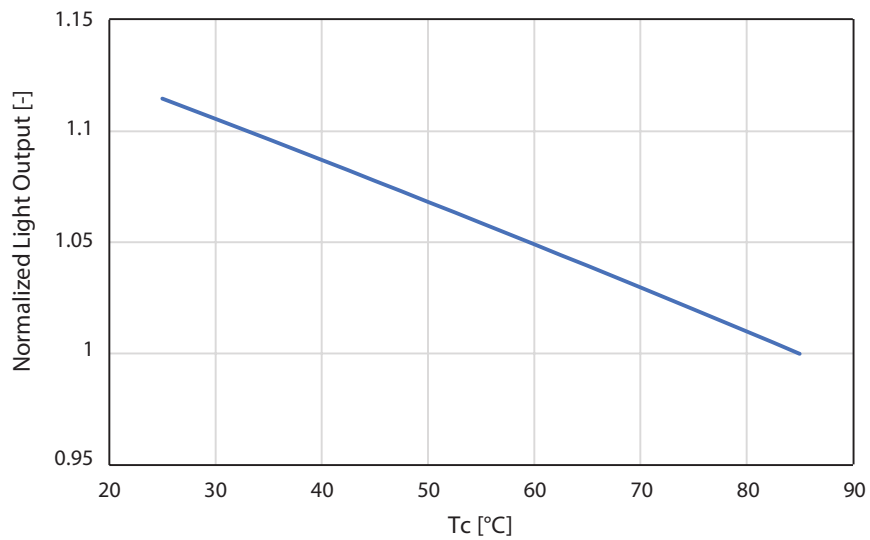

Figure 4. Typical normalized light output vs. Tc temperature for LUXEON XR-5050 HE at 1050mA.

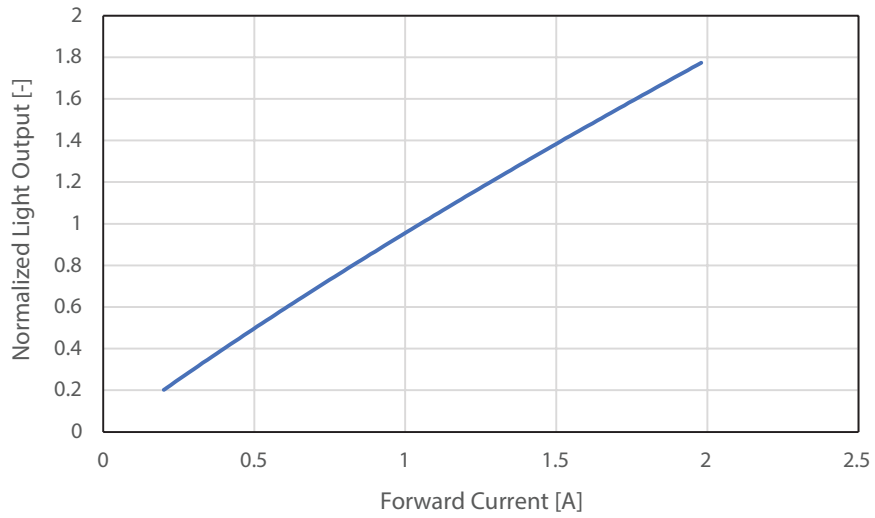

Figure 5. Typical normalized light output vs. forward current for XR-5050 HE at $T_c=85^\circ\text{C}$.

Efficacy Characteristics

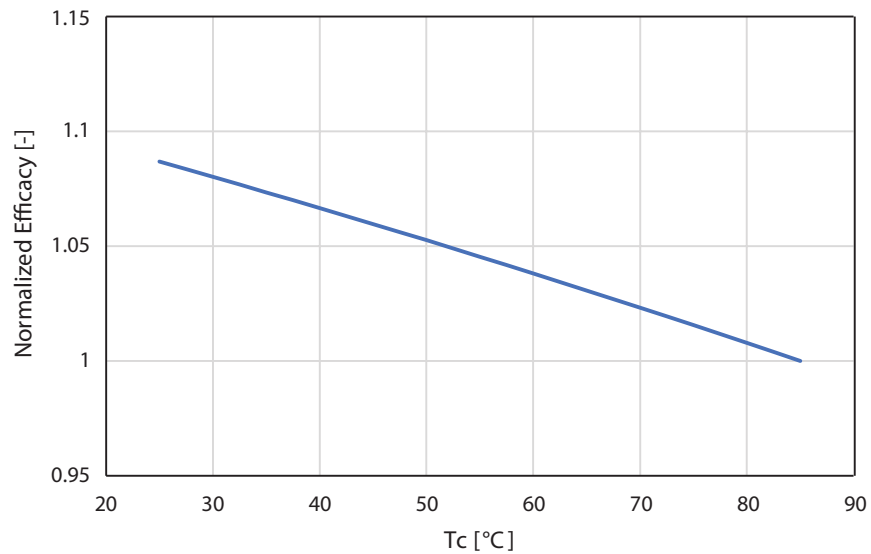

Figure 6. Typical normalized efficacy vs. T_c temperature for LUXEON XR-5050 HE at 1050mA.

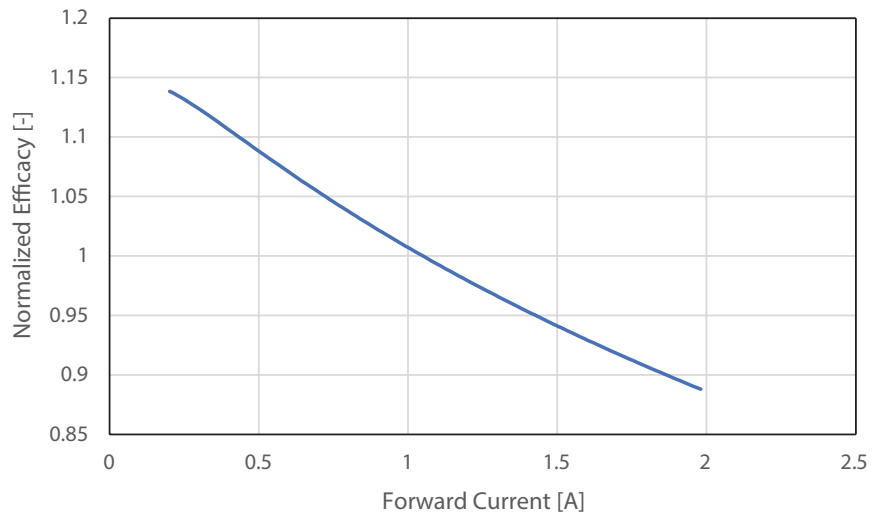

Figure 7. Typical normalized efficacy vs. forward current for LUXEON XR-5050 HE at $T_c=85^\circ\text{C}$.

Mechanical Dimensions

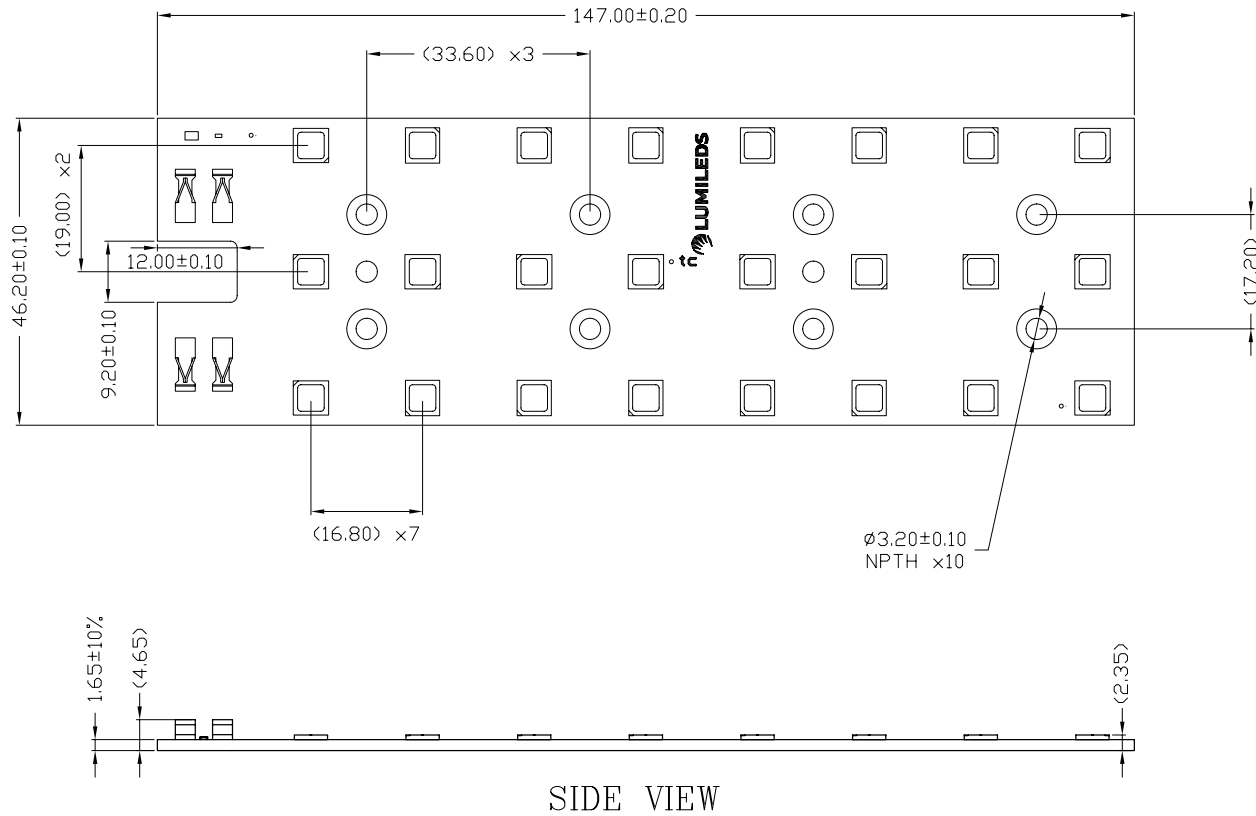

Figure 8. Mechanical dimensions for LUXEON XR-5050 HE.

Notes for Figure 8:

1. Drawings are not to scale.
2. All dimensions are in millimeters.

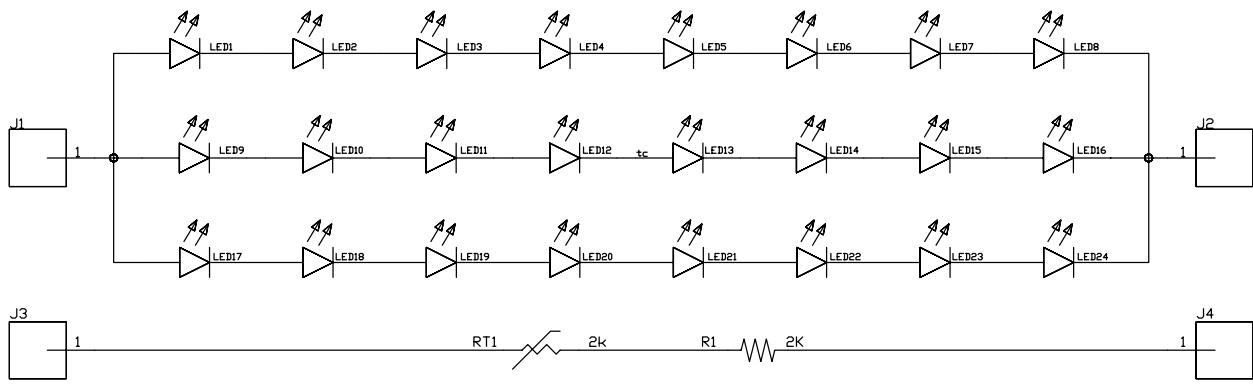

Figure 9. Electric circuit diagram for LUXEON XR-5050 HE.

Table 7. Bill of Material for LUXEON XR-5050 HE.

COMPONENT	QUANTITY
LED: LUXEON 5050 HE	24
PCB: MCPCB	1
1-pole Connector	4
NTC 15Kohm	1
Resistor 2Kohm	1

Packaging Information

Table 8. Packing information for LUXEON XR-5050 HE.

PART NUMBER	QUANTITY PER TRAY	TRAY QUANTITY PER BOX	STANDARD PACKING INCREMENT, SPI	SHIPPING BOX DIMENSION, L x W x H (mm)
L225-xxxx024MLU010	20	5	80	390x382x100

About Lumileds

Companies developing automotive, mobile, IoT and illumination lighting applications need a partner who can collaborate with them to push the boundaries of light. With over 100 years of inventions and industry firsts, Lumileds is a global lighting solutions company that helps customers around the world deliver differentiated solutions to gain and maintain a competitive edge. As the inventor of Xenon technology, a pioneer in halogen lighting and the leader in high performance LEDs, Lumileds builds innovation, quality and reliability into its technology, products and every customer engagement. Together with its customers, Lumileds is making the world safer, better and more beautiful—with light.

To learn more about our lighting solutions, visit lumileds.com.



©2023 Lumileds Holding B.V. All rights reserved.
LUXEON is a registered trademark of the Lumileds Holding B.V. in the United States and other countries.

lumileds.com

Neither Lumileds Holding B.V. nor its affiliates shall be liable for any kind of loss of data or any other damages, direct, indirect or consequential, resulting from the use of the provided information and data. Although Lumileds Holding B.V. and/or its affiliates have attempted to provide the most accurate information and data, the materials and services information and data are provided "as is," and neither Lumileds Holding B.V. nor its affiliates warrants or guarantees the contents and correctness of the provided information and data. Lumileds Holding B.V. and its affiliates reserve the right to make changes without notice. You as user agree to this disclaimer and user agreement with the download or use of the provided materials, information and data. A listing of Lumileds product/patent coverage may be accessed at lumileds.com/patents.