

---

# Coaxial Pigtailed Laser Module

## Technical Data

**LST252X - 200  $\mu$ W Coaxial Laser**  
**LST282X - 1 mW Coaxial Laser**  
**LST292X - 1.6 mW Coaxial Laser**  
**LST3X21 - Dual-in-Line Package**

---

### Features

- **Compact Coaxial Package**
- **Strained Multi Quantum Well (SMQW) Laser Chip**
- **Low Thresholds Current and Operating Currents**
- **Wide Operating Temperature -40°C to +85°C**
- **Optical Power May Be Customized up to 2 mW**
- **Modulation Capability up to 622 Mb/s**
- **Convenient Variety of Pinout and Mounting Flange Options**

### Applications

- **Telecommunications**
- **Fiber in the Loop**
- **Inter/Intra Office**
- **SONET/SDH**
- **Datacommunications**
- **Switches**

### Description

Products in the LST2X2X family are compact coaxial pigtailed laser transmitters, operating in the 1300 nm wavelength region and coupling light to single mode fiber. They are designed for use in short, medium and long distance networks with bit rates up to 622 Mb/s.

The device features a high reliability SMQW laser diode and rear facet monitor photodiode. These are electrically connected to four pins in an industry-standard configuration.

Environmental performance is designed to be compatible with the requirements of Bellcore's TA-NWT-000983 document.

Options within the LST2X2X family offer pinouts and pin rotational orientations designed to match existing products

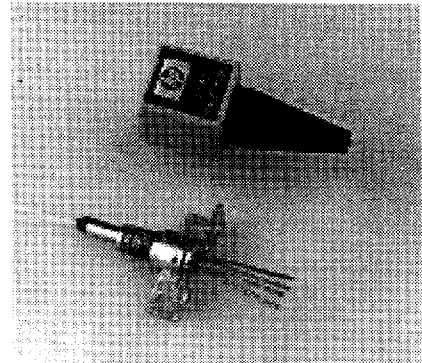

available on the market. We also offer a comprehensive range of alternative mounting flanges including a dual in line option.

If the specific arrangement or performance you require is not listed, please contact your local representative as our highly flexible design and manufacturing processes allow both physical and electro-optical customization to meet your needs.

#### Laser Safety Warning

This device is a Class IIIb (3b) Laser Product. It may emit invisible laser radiation if operated with the fiber pigtail disconnected. To avoid possible eye damage do not look into an unconnected fiber pigtail during laser operation. Do not exceed specified operating limits.

## Absolute Maximum Ratings

Absolute limiting (maximum) ratings mean that no catastrophic damage will occur if the product is subjected to these ratings for short periods, provided that each limiting parameter is in isolation and all other parameters have values within the performance specification. It should not be assumed that limiting values of more than one parameter can be applied to the product at the same time.

Parameter	Symbol	Test Condition	Limits		Units
			Min.	Max.	
Laser Forward Current	If	DC		120	mA
Laser Reverse Voltage	Vlr	DC		2	V
Photodiode Reverse Voltage	Vr	DC		20	V
Photodiode Forward Current	Ipf	DC		1	mA
Operating Temperature	Tc	Temperature measured at case	-40	+85	°C
Storage Temperature	Ts		-40	+85	°C
Relative Humidity	RH		noncondensing		%RH
Fiber Pull Strength		Three times; 10 sec.		10	N
Mechanical Shock		MIL-STD-883D, Method 2002, Condition A		500	G
Vibration		MIL-STD-883D, Method 2007, Condition A		20	G

## Performance Specifications

Parameter	Symbol	Test Condition	LST252X LST3521		LST282X LST3821		LST292X LST3921		Units
			Min.	Max.	Min.	Max.	Min.	Max.	
<b>LASER</b>		CW, Tc = -40°C to +85°C, Po as noted below unless otherwise stated							
Rated Optical Power	Po	Tc = ranges specified above, CW	0.2		1.0		1.6		mW
Threshold Current	Ith	Tc = +25°C	3.5	10	3.5	10	3.5	10	mA
Threshold Current	Ith		1.5	30	1.5	30	1	30	mA
Coupled Power in "Off" State	Pth	If = Ith - 2 mA		10		10		10	μW
Slope Efficiency	η	Tc = +25°C	10	16	50	80	80	128	μW/mA
Drive Current above Ith, for Im = Im (Po, +25°C)	Id	Tc = +25°C	12.5	20	12.5	20	12.5	20	mW
		Tc = -40°C to +85°C	10	33.3	10	33.3	10	33.3	mA
Forward Voltage	Vf			1.6		1.6		1.6	V
Center Wavelength	λ	Tc = +25°C	1286	1336	1286	1336	1286	1336	nm
		Tc = -40°C to +85°C	1260	1360	1260	1360	1260	1360	nm
Wavelength/Temperature Coefficient	Δλ/ΔT			0.4		0.4		0.4	nm/°C
Spectral Width	σ	One sigma, RMS		2.5		2.5		2.5	nm
Rise and Fall Time	τ	10-90%, Ith to Po		0.5		0.5		0.5	ns

**Performance Specifications (continued)**

Parameter	Symbol	Test Condition	LST252X LST3521		LST282X LST3821		LST292X LST3921		Units
			Min.	Max.	Min.	Max.	Min.	Max.	
<b>MONITOR PHOTODIODE</b>		Tc = +25°C, Vr = 5 V, Po = Rated Power							
Photocurrent	Im		200	1000	200	1000	200	1000	μA
Dark Current	Id	Po = 0 μW		20		20		20	nA
Capacitance	C	1 MHz		10		10		10	pF
Tracking Error	DR	Im = Im (Po, +25°C) Tc + -40°C to + 85°C	-1	+1	-1	+1	-1	+1	dB
Rise and Fall Time	tr	10-90%, Ith to Po		2		2		-	ns

**Fiber Pigtail**

Parameter	Minimum	Maximum	Units
Fiber Pigtail Length	1000		mm
Spot Size (Mode Radius)	4.5	5.5	μm
Cladding Diameter	122	128	μm
Core/Cladding Concentricity		1	μm
Secondary Jacket Diameter	0.8	1	mm
Effective Cutoff Wavelength	1150	1240	nm

**Reliability Target**

Parameter	Condition	Min.	Max.	Units
Median Life	50% inc. in total drive current, Tc = +25°C	2x10 <sup>5</sup>		hours

**Other Documentation**

SMQW Laser Diode Reliability Datasheet  
LST282X/LST292X/LST3821/LST3921  
Interim Qualification Report

Publication number 5965-1293E

Publication number 5965-5374E

**Example of LST2X2X – All dimensions in mm.**

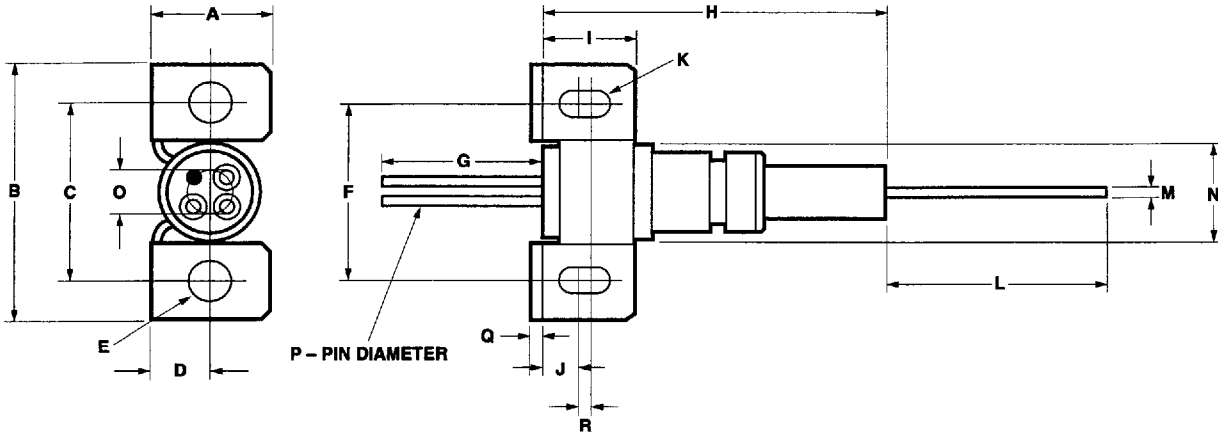

DIM.	MIN.	TYP.	MAX.	DIM.	MIN.	TYP.	MAX.	DIM.	MIN.	TYP.	MAX.
A		7.4		G	12.0			M		0.9	
B		17.0		H			20.0	N		5.3	
C	11.8		12.2	I		5.3		O		2.0	
D		3.7		J		2.0		P	0.4		0.5
E	2.4		2.6	K	2.1		2.3	Q		0.5	
F	12.5		12.9	L		1000		R		1.25	

**LST3X21 Specification – All dimensions in mm.**

**PINOUT OPTIONS**

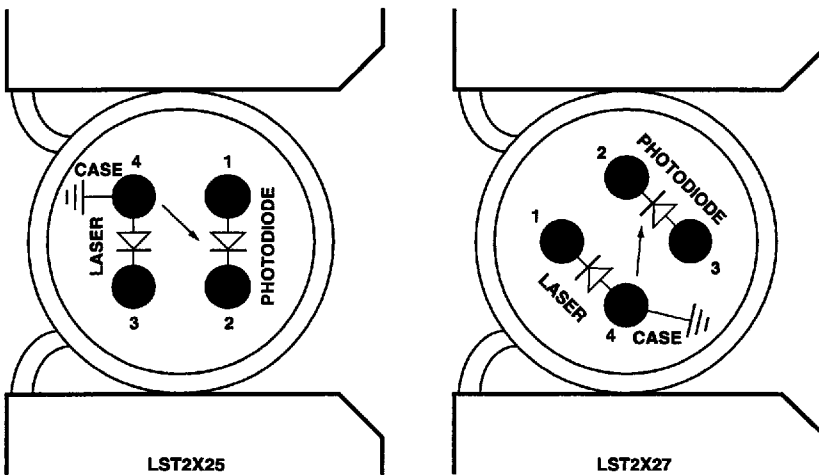

**LST2X25**

PIN	FUNCTION
1	MONITOR ANODE (-VE)
2	MONITOR CATHODE (+VE)
3	LASER CATHODE (-VE)
4	LASER ANODE (+VE)

**LST2X27**

PIN	FUNCTION
1	LASER CATHODE (-VE)
2	MONITOR CATHODE (+VE)
3	MONITOR ANODE (-VE)
4	LASER ANODE (+VE)

**LST3X21 Specification** – All dimensions in mm.

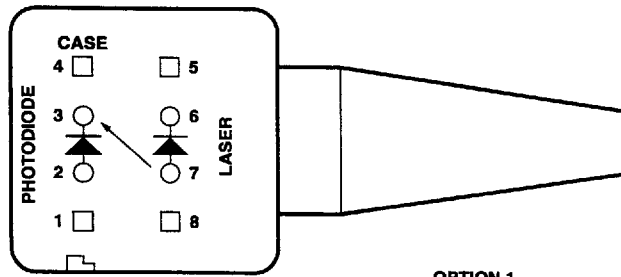
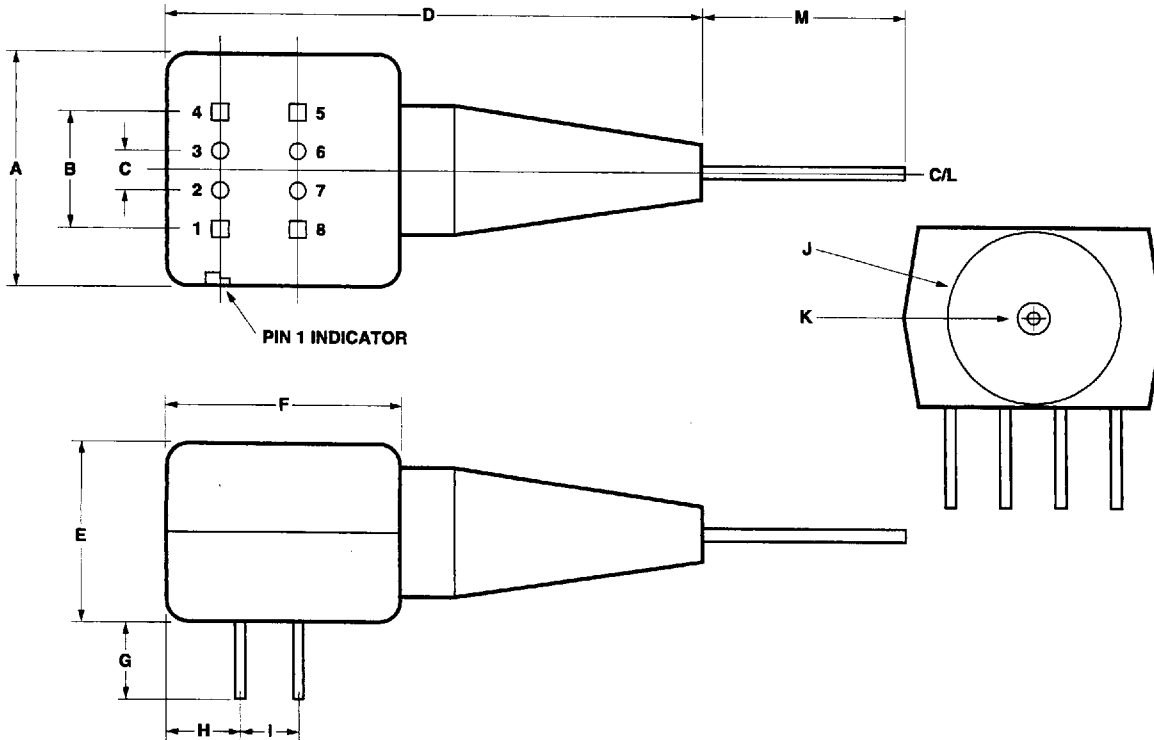

PIN	FUNCTION
1	NO CONNECTION
2	MONITOR ANODE (-VE)
3	MONITOR CATHODE (+VE)
4	NO CONNECTION
5	NO CONNECTION
6	LASER CATHODE (-VE)
7	LASER ANODE (+VE) (CONNECTED TO HEADER)
8	NO CONNECTION

**NOTE:**  
PINS 1, 4, 5, AND 8 ARE ISOLATED FROM THE INTERNAL CIRCUITRY, BUT ARE ELECTRICALLY CONNECTED TO EACH OTHER.

PINS 1, 4, 5, & 8 – 0.51 x 0.38 NOM.  
PINS 2, 3, 6, & 7 – 0.4/0.5 DIA.

DIM.	TYP.	DIM.	TYP.	DIM.	TYP.
A	12.60	E	10.20	I	2.54
B	7.62	F	12.60	J	8.60
C	2.54	G	4.26	K	3.20
D	30.00	H	3.53	M	1000

## Ordering Information

### Coaxial Package

LST2X2X - XX - Y - ZZ

Connector Type:  
FP = FC/PC  
ST\* = ST  
SC = SC  
DN = DIN  
SF = Superpolish FC/PC

Flange:  
B = Without mounting flange  
T = Universal flange

Empty = 155 Mb/s operation  
S4 = 622 Mb/s operation

Pinout:  
5 = see pinout diagram  
7 = see pinout diagram

Power:  
5 = Po = 200 μW  
8 = Po = 1 mW  
9 = Po = 1.6 mW

### Dual-in-Line Package

LST3X21 - XX - ZZ

Connector Type:  
FP = FC/PC  
ST\* = ST  
SC = SC  
DN = DIN  
SF = Superpolish FC/PC

Empty = 155 Mb/s operation  
S4 = 622 Mb/s operation

Power:  
5 = Po = 200 μW  
8 = Po = 1 mW  
9 = Po = 1.6 mW

\*ST® is a registered trademark of AT&T.

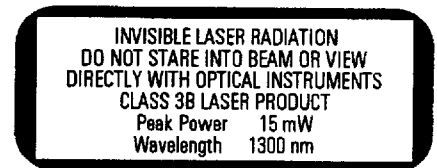

IEC825-1 1993

### Laser Warning

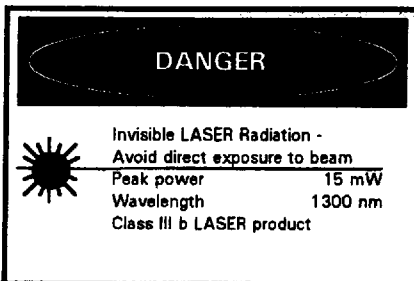

### CDRH Certification

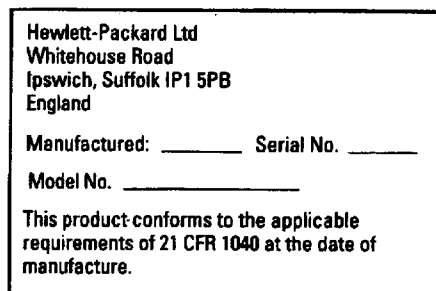

For technical assistance or the location of your nearest Hewlett-Packard sales office, distributor or representative call:

**Americas/Canada:** 1-800-235-0312 or 408-654-8675

**Far East/Australasia:** Call your local HP sales office.

**Japan:** (81 3) 3335-8152

**Europe:** Call your local HP sales office.

Data subject to change.

Copyright © 1997 Hewlett-Packard Co.

Obsoletes 5965-5373E, 5962-9395E  
Printed in U.S.A. 5965-7336E (4/97)

