



DBM-145
Subminiature Flatpack
Double Balanced Mixer
10-1500 MHz



DESCRIPTION

S.M.D.I. Model DBM-145 is a high performance subminiature double balanced mixer utilizing precision matched beam-lead Schottky barrier diodes. The L and R ports have a bandwidth of 10 MHz to 1500 MHz while the X port covers a bandwidth of DC to 1000 MHz. Inputs to any two ports within their specified frequency range will produce the sum and difference frequency at the third port, with a minimum of undesired harmonic modulation products. The double balanced mixer may be used as an up converter, down converter, spectrum inverter or for any other frequency changing application. Other uses are as a phase detector, double sideband suppressed carrier modulator, bi-phase modulator, pulse modulator or a frequency doubler. The combination of S.M.D.I. broadband transformer techniques plus the use of beam-lead Schottky barrier diodes achieve consistent low mixer noise figures and stable isolations. Precise transformer and diode balance provide two-tone third order IM ratios of better than 80 dB with -30 dBm input signals. Unique transformer design allows almost constant intermodulation suppression over the mixer's entire operating frequency range.

The subminiature package is sealed, RFI shielded and internally constructed to withstand severe environments. The device configuration allows convenient microstrip or printed circuit board mounting and the leads are easily soldered or welded.

GUARANTEED MINIMUM PERFORMANCE DATA

TEST CONDITION:

LO + 7 dBm (High side LO)
 RF - 10 dBm
 IF 100 MHz

NOTE:

Specifications below, guaranteed with IF from DC to 500 MHz. For higher IF frequencies, consult IF response curve for typical rolloff.

OVERALL FREQUENCY RANGE IN MHz:

L	R	X
10-1500	10-1500	DC-1000

FREQUENCY BANDS IN MHz:

	10-200	200-500	500-1500
Conversion Loss	7.0	6.0	8.5
L-R Isolation	35	30	25
L-X Isolation	35	30	15
R-X Isolation	25	20	15

ABSOLUTE MAXIMUM RATINGS:

Operating Temp. -54 to +100°C
 X-port Input Current 50 mA
 Total Input Power 200 mW @ +25°C
 Derate linearly to 50 mW @ 100°C

DC POLARITY

Negative with L and R port signals in-phase.

Specifications subject to change without notice.

8.10.04 Rev. A

TYPICAL PERFORMANCE

Impedance: All ports 50 ohms
 1 dB Compression Point: 0 dBm
 1 dB Desensitization Point: -2 dBm
 3rd Order Intercept Point: +12 dBm
 Noise Figure is within 1 dB of conversion loss
 LO Power Range: +4 to +13 dBm

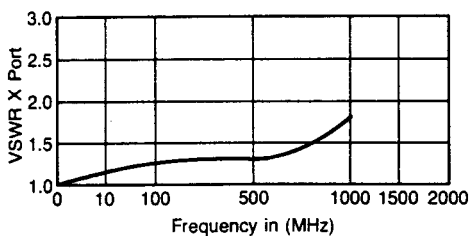
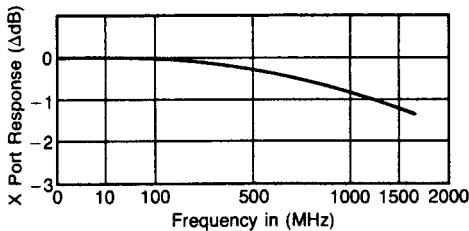
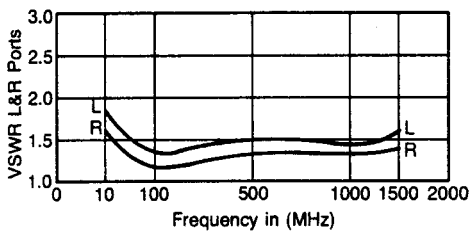
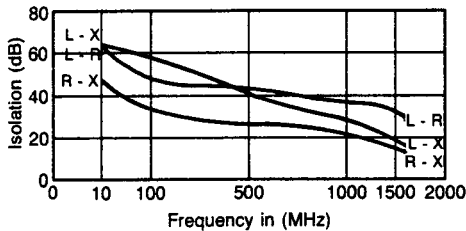
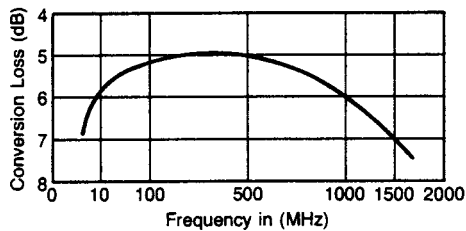

ENVIRONMENTAL CONDITIONS

GUARANTEED ENVIRONMENTAL PERFORMANCE:

All units are designed to meet their specifications over -54°C to +100°C and after exposure to any or all of the following tests per MIL-STD-202E.

Exposure	Method	Test Condition
Thermal Shock	107D	B
Altitude	105C	G
H.F. Vibration	204C	D
Mechanical Shock	213B	C
Random Vibration	214	IIF
(15 minutes per axis)		
Solderability	208C	
Terminal Strength	211A	C
Resistance to Soldering Heat	210A	B

Sealed units, meet the requirements of Method 106D of MIL-STD-202E when exposed to humidity.

FUNCTIONAL SCHEMATIC

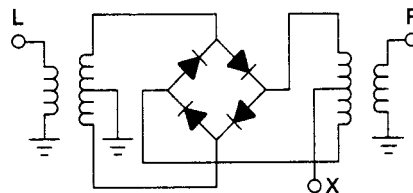

PACKAGE

CASE MATERIAL:

F15 Kovar per ASTM Standard F-15-68, (Chemical Composition per MIL-STD-1276, Type K)

FINISH:

Plating, all metal parts: gold per MIL-G-45204, Type I, Grade A, Class 1, over nickel per MIL-C-26074, Class 1

LEADS:

Kovar per MIL-STD-1276, Type K

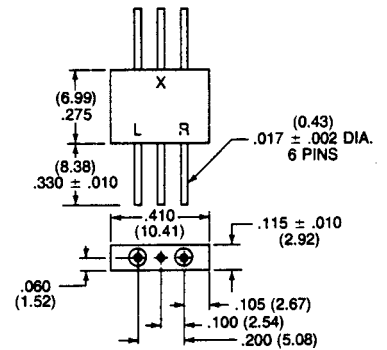

ALL UNLABELED PINS ARE GROUND

Specifications subject to change without notice.