

SMB8501-0000

SMB Jack Bulkhead

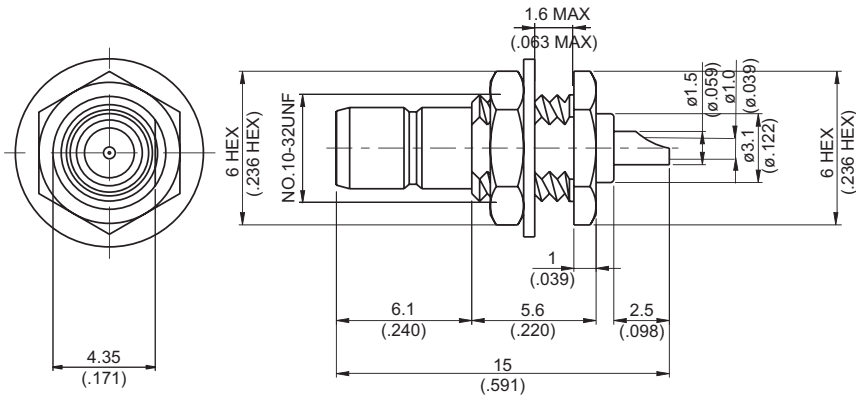

MOUNTING HOLE :

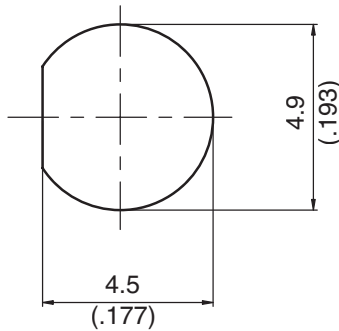

Parts	Material	Plating (Micro-inch)
Hex Nut	Brass	Gold 5 Over Nickel 50 Over Copper 50
Lock	Brass	Gold 5 Over Nickel 50 Over Copper 50
Contact Pin	Brass	Gold 20 Over Nickel 50 Over Copper 50
Insulator	Teflon	
Body	Brass	Gold 5 Over Nickel 50 Over Copper 50

Weight: 1.16 g

This part number complies with RoHS.

Notice: JYEBAO reserves the right to make modifications deemed appropriate.