

# INDEX (Click the Series Titles)

TAJIMI ELECTRONICS CO., LTD.

Series	Features	Connections	Frequency Range	Cable Type or Wire Size	Solder/Crimp	Page
<b>OPS/OPC</b>	Fiber Optic HDTV Camera Connectors	Push-Pull		Mohawk/CDT M96040, ARIB, Other Cable		1 ~ 4
<b>BNC</b>	50 /75 BNC Coaxial Connectors	Bayonet Lock	50ohm 0- 4 GHz 75ohm 0-2.4GHz	RG/JIS Cable	Solder/Crimp	5
<b>BNCs</b>	Push-Pull BNC Coaxial Connectors	Push-Pull	50ohm 0- 4 GHz 75ohm 0-2.4GHz	RG/JIS Cable	Solder/Crimp	6,7
<b>V</b>	Video Patch Plug	Snap-On	0-1.5GHz	RG/JIS Cable	Solder/Crimp	7
<b>BNCW</b>	Water Proof BNC Connectors (Water Resistance)	Bayonet Lock	50ohm 0- 4 GHz 75ohm 0-2.4GHz	RG/JIS Cable	Solder/Crimp	8
<b>PW</b>	Water Proof Coaxial Connectors 300kPa	Screw Coupling	0-200MHz	RG/JIS Cable	Solder	8
<b>TMA</b>	SMA Series Connectors (MIL-C-39012 SMA Compliance)	Screw Coupling	0-18GHz 0-12.4GHz	RG Cable	Solder/Crimp	9,10
<b>SSMA</b>	SSMA Series Connectors (MIL-C-39012 SSMA Compliance)	Screw Coupling	0-35GHz	RG Cable	Solder/Crimp	10
<b>MPX</b>	Triaxial Connectors for TV Camera	Push-Pull	0-1.5GHz	Triaxial Cable	Solder	11
<b>TXA</b>	Triax Connectors, Miniature 3 lug (MIL-C-49142 TRB Compliance)	Bayonet Lock	0-500MHz	Triaxial Cable	Solder	12
<b>TXE</b>	Triax Connectors, Miniature 2 lug (MIL-C-49142 TRB Compliance)	Bayonet Lock	0-500MHz	Triaxial Cable	Solder	12
<b>MCX</b>	Triax Connectors, Miniature 2 lug (MIL-C-49142 TRC Compliance)	Bayonet Lock	0-600MHz	Triaxial Cable	Solder	12
<b>C25</b>	Miniature Coaxial Connectors for Piezoelectric Sensors	Screw Coupling	0-200MHz	Low-Noise/RG Cable	Solder/Crimp	13
<b>C29</b>	Miniature Coaxial Connectors for Piezoelectric Sensors	Screw Coupling	0-200MHz	Low-Noise Cable	Solder/Crimp	13
<b>TMG</b>	Miniature Coaxial Connectors for Piezoelectric Sensors	Screw Coupling	0-200MHz	Low-Noise Cable	Solder/Crimp	13
<b>1321</b>	SMC Subminiature Coaxial Connectors	Screw Coupling	0-1GHz	RG/JIS Cable	Solder/Crimp	14
<b>1322</b>	Screw-On ,75 Type, Subminiature Coaxial Connectors	Screw Coupling	0-1GHz	RG/JIS Cable	Solder	14
<b>1323</b>	SMB Subminiature Coaxial Connectors	Snap-On	0-1GHz	RG/JIS Cable	Solder/Crimp	14
<b>1324</b>	Snap-On, 75 Type, Subminiature Coaxial Connectors	Snap-On	0-1GHz	RG/JIS Cable	Solder	14
<b>C33</b>	Snap-On Subminiature Coaxial Connectors	Snap-On	0-1GHz	RG/Other Cable	Solder/Crimp	14
<b>MHV</b>	MHV Coaxial Connectors (High Voltage Type)	Bayonet Lock	-	RG/JIS Cable	Solder/Crimp	15
<b>SHV</b>	SHV Coaxial Connectors (High Voltage Type)	Bayonet Lock	-	RG/JIS Cable	Solder/Crimp	15
<b>HN</b>	HN Coaxial Connectors (High Voltage Type)	Screw Coupling	0-3GHz	RG/JIS Cable	Solder	15
<b>TNC</b>	TNC Coaxial Connectors	Screw Coupling	0-11GHz	RG/JIS Cable	Solder	16
<b>UHF</b>	UHF Coaxial Connectors	Screw Coupling	0-200MHz	RG Cable	Solder	16
<b>N</b>	N Coaxial Connectors	Screw Coupling	0-10GHz	RG/JIS Cable	Solder/Crimp	16
<b>C</b>	C Coaxial Connectors	Bayonet Lock	0-10GHz	RG/JIS Cable	Solder	16
<b>AD</b>	Between Series Coaxial Adapters	-	-	-	-	17
<b>MR01</b>	Multi-Pin Micro Connectors 4pins,Shock:500G	Screw Coupling	-	AWG#28	Solder	13
<b>1108</b>	Water Proof Circular Connectors 300kPa. 2 ~ 37pins	Screw Coupling	-	AWG#16 ~ 20	Solder	18,19
<b>R04</b>	Water Proof Circular Connectors 200kPa. 2 ~ 12pins	Screw Coupling	-	AWG#24	Solder	20,21
<b>R28</b>	Water Proof Circular Connectors 200kPa. 8 ~ 12pins, High-Density Type	Screw Coupling	-	AWG#26	Solder	20,21
<b>R14</b>	Water Proof Circular Connectors 1.000kPa. 2 ~ 37pins	Screw Coupling	-	AWG#16 ~ 20	Solder	22
<b>PRC03</b>	Push-Pull Locking Circular Connectors 2 ~ 7pins	Push-Pull	-	AWG#16 ~ 20	Solder	23,24
<b>PRC04</b>	Push-Pull Circular Connectors 8 ~ 37pins	Push-Pull	-	AWG#16 ~ 20	Solder	23,24
<b>PRC05</b>	Push-Pull Circular Connectors 2 ~ 12pins	Push-Pull	-	AWG#24	Solder	25,28
<b>PRC07</b>	Push-Pull Circular Connectors 8 ~ 12pins, High-Density Type	Push-Pull	-	AWG#26	Solder	25,28
<b>R03</b>	Miniature Circular Connectors 2 ~ 12pins	Screw Coupling	-	AWG#24	Solder	26,28
<b>R27</b>	Miniature Circular Connectors 8 ~ 12pins, High-Density Type	Screw Coupling	-	AWG#26	Solder	26,28
<b>R05</b>	Bayonet Miniature Circular Connectors 2 ~ 12pins	Bayonet Lock	-	AWG#24	Solder	27,28
<b>R29</b>	Bayonet Miniature Circular Connectors 8 ~ 12pins, High-Density Type	Bayonet Lock	-	AWG#26	Solder	27,28

# Fiber Optic HDTV Camera Connectors

OPC series / OPS series

## ■ Features (OPC and OPS series)

- Tajimi proprietary three-guide-ball "push-pull" one-touch lock system is adopted, assuring reliable connection and ease of use. Superior to a threaded system, this system has advantages such as a "snap" that confirms locking, less metal wear and superior consistency finding its way in wide variety of industrial applications.
- The system enables power supply in addition to transmission of optical and electric signals.
- Suitable for a wide variety of applications with flexible combinations in the range from 2 optical pins/4 electric pins to 6 optical pins.
- Ultra tight waterproof in the connected state in heavy duty use. Superior weather-proof feature with protection boots and a waterproof cap.
- Excellent cable connection strength suitable for cabling in the field. Mechanical cable connecting system withstands environmental changes.
- Coaxial shield processing structure resistant to external noises caused by electric signals or a power source.
- Cable assemblies such as compound multi-cable, and fiber cords with FC- and SC-type connectors are also available.

## ■ Applications (OPC and OPS series)

DTV / HDTV camera system  
 Graphics transmission system  
 Outdoor / indoor monitoring system  
 LAN system  
 Industrial robotics



## ■ Specifications (OPC and OPS series)

Contents / Series		OPC series		OPS series	
Connections		Push-Pull Lock			
Number of Pins		6 pins			
		Opt.2 / Ele.4	Opt.4 / Ele.2 Opt.6	Opt.2 / Ele.4	Opt.4 / Ele.2 Opt.6
Optical	Insertion Loss	0.7dB Max. (SMF) 0.5dB Max. (MMF)	0.7dB Max. (SMF) 0.5dB Max. (MMF)	0.5dB Max.	0.7dB Max. (SMF) 0.5dB Max. (MMF)
	Return Loss	≥ 30 to 50dB (depending upon the polishing method)			
	Applicable Fiber	GI 50/125 (Multi-Mode), SM 10/125 (Single-Mode)			
Mechanical & Environmental	Waterproof (connected state)	IP67 (at a water depth of 1.5m, 48H)			
	Durability	5,000 cycles	3,000 cycles	5,000 cycles	3,000 cycles
	Corrosion Resistance	MIL-STD-202 Method 101 48H			
Electrical (Optic Electric Hybrid Type Only)	Voltage Rating	AC500V RMS			
	Current Rating	10A			
	Withstanding Voltage	Contact to Contact AC2,000V RMS, Body to Contact AC1,000V RMS			
	Insuration Resistance	DC1,000V 1,000MΩ min.			
Dimension (mm)	Length / Max. Outer Diameter	OPC92405-P	131mm / φ32mm	OPS92405-P	125mm / φ26.5mm
		OPC92406-J	130mm / φ27.2mm	OPS92406-J	123mm / φ22.5mm
		OPC112-R	46mm / S.Q 36mm	OPS2402-R	43mm / S.Q 29mm
		OPC114-PR (Coupling Ring O.D.φ42)	47mm / S.Q 36mm	OPS2404-PR (Coupling Ring O.D.φ36)	44mm / S.Q 29mm

# Fiber Optic HDTV Camera Connectors

OPC series / OPS series



Plug OPC92405-P-(c)



Jack OPC92406-J-(c)



Receptacle OPC112-R



Plug Receptacle OPC114-PR

## Models

Connector Part No.	No. of Pins (Opt. / Ele.)	Configuration	Boot Part No.	Cap Part No.	Cable (O.D.)
● OPC series					
OPC92405-P-(c)	Opt.2 / Ele.4	Cable Plug	OPC115-PB	OPC119-PC	Mohawk/CDT M96040 UL AWM STYLE 20907
OPC92406-J-(c)		Cable Jack	OPC116-JB	OPC120-JC	
OPC92409-P-(c)		Cable Plug	OPC115-PB	OPC119-PC	FURUKAWA ELECTRIC TV-OM-AM (φ9.2) UL AWM STYLE 5410
OPC92410-J-(c)		Cable Jack	OPC116-JB	OPC120-JC	
OPC113-P-(c)		Cable Plug	OPC115-PB	OPC119-PC	TV-OM-CF (φ8.6)
OPC123-J-(c)		Cable Jack	OPC116-JB	OPC120-JC	
OPC112-R		Receptacle	-----	OPC118-RC	φ2.8 Fiber cord x 2
OPC114-PR		Plug Receptacle	-----	OPC117-PC	
OPC4005-P-(c)	Opt.4 / Ele.2	Cable Plug	OPC115-PB	OPC119-PC	4SM-9.2-37.5-FRE (φ9.2)
OPC4006-J-(c)		Cable Jack	OPC116-JB	OPC120-JC	
OPC4002-R		Receptacle	-----	OPC118-RC	φ2.8 Fiber cord x 4
OPC4004-PR		Plug Receptacle	-----	OPC117-PC	
OPC6007-P-(c)	Opt.6	Cable Plug	OPC115-PB	OPC119-PC	SOF-6 x 10/125-TUFRET (φ10.0)
OPC6005-J-(c)		Cable Jack	OPC116-JB	OPC120-JC	
OPC6004-R		Receptacle	-----	OPC118-RC	φ2.8 Fiber cord x 6
OPC6006-PR		Plug Receptacle	-----	OPC117-PC	
● OPS series					
OPS92405-P-(c)	Opt.2 / Ele.4	Cable Plug	FS121-PB	FS122-PC	Mohawk/CDT M96040 UL AWM STYLE 20907
OPS92406-J-(c)		Cable Jack	FS123-JB	FS124-JC	
OPS92409-P-(c)		Cable Plug	FS121-PB	FS122-PC	FURUKAWA ELECTRIC TV-OM-AM (φ9.2) UL AWM STYLE 5410
OPS92410-J-(c)		Cable Jack	FS123-JB	FS124-JC	
OPS2407-P-(c)		Cable Plug	FS121-PB	FS122-PC	2SM-12-15.3 (φ12.0)
OPS2408-J-(c)		Cable Jack	FS123-JB	FS124-JC	
OPS2402-R		Receptacle	-----	FS125-RC	φ2.0 Fiber cord x 2
OPS2404-PR		Plug Receptacle	-----	FS126-PC	
OPS2406-PP		Panel Mount Cable Plug	-----	FS126-PC	2SM-9.2-37.5 (φ9.2)
OPS2405-PJ		Panel Mount Cable Jack	-----	FS125-RC	
OPS6001-P-(c)	Opt.6	Cable Plug	FS121-PB	FS122-PC	SOF-6 x 10/125-TUFRET (φ10.0)
OPS6003-J-(c)		Cable Jack	FS123-JB	FS124-JC	
OPS6002-R		Receptacle	-----	FS125-RC	φ2.0 Fiber cord x 6
OPS6004-PR		Plug Receptacle	-----	FS126-PC	

Colour	Red	Green	Blue	Black	Gray	None
Code No.	RE	GE	BU	BK	GY	N



Plug OPS92405-P-(c)



Jack OPS92406-J-(c)



Receptacle OPS2402-R



Plug Receptacle OPS2404-PR

# Fiber Optic HDTV Camera Connectors

OPC series / OPS series



[ A ] Plug-Jack Cable Assembly  
FW-0003-(<sup>L</sup>)-GR



[ C ] Plug Receptacle Cable Assembly  
FB-0003-(<sup>L</sup>)



[ B ] Receptacle Cable Assembly  
FB-0002-(<sup>L</sup>)

## ■ Cable Assembly Models

Configuration		Part No.	Combination of connectors at both ends		Cable(O.D.)	Remarks
● OPC series						
A	Plug - Jack Multi-cable Assembly	FW-0003-( <sup>L</sup> )-( C )	OPC9205-P-( C )	OPC92406-J-( C )	Mohawk/CDT M96040 (φ 9.2)	with Boots and Caps
		FW-0004-( <sup>L</sup> )-( C )	OPC92409-P-( C )	OPC92410-J-( C )	FURUKAWA TV-OM-AM (φ 9.2)	
		FB-0001-( <sup>L</sup> )-( C )	OPC111-P-( C )	OPC113-J-( C )	TV-OM-CF (φ 8.6)	
		FB-0057-( <sup>L</sup> )-( C )	OPC128-P-( C )	OPC129-J-( C )	2SM-9.2-37.5 (φ 9.2)	
		FB-0073-( <sup>L</sup> )-( C )	OPC130-P-( C )	OPC131-J-( C )	2SM-12-15.3 (φ12.0)	
B	Receptacle Fiber-code Assembly	FB-0002-( <sup>L1</sup> )-( L2 )	OPC112-R	TFC106-PS6	SM 10/125 Fiber code (φ 2.8)	φ 2.8 Fiber code with FC or SC connector x 2 Lead wire x 4
		FB-0015-( <sup>L1</sup> )-( L2 )		TSC101-PS6		
C	Plug receptacle Fiber-code Assembly	FB-0003-( <sup>L1</sup> )-( L2 )	OPC114-PR	TFC106-PS6		
		FB-0016-( <sup>L1</sup> )-( L2 )		TSC101-PS6		
● OPS series						
D	Plug - Jack Multi-cable Assembly	FW-0001-( <sup>L</sup> )-( C )	OPS92405-P-( C )	OPS92406-J-( C )	Mohawk/CDT M96040 (φ 9.2)	with Boots and Caps
		FW-0002-( <sup>L</sup> )-( C )	OPS92409-P-( C )	OPS92410-J-( C )	FURUKAWA TV-OM-AM (φ 9.2)	
		FA-0010-( <sup>L</sup> )-( C )	OPS2401-P-( C )	OPS2403-J-( C )	2SM-9.2-37.5 (φ 9.2)	
E	Receptacle Fiber-code Assembly	FA-0008-( <sup>L1</sup> )-( L2 )	OPS2402-R	TFC106-PS6	SM 10/125 Fiber code (φ 2.0)	φ 2.0 Fiber code with FC or SC connector x 2 Lead wire X 4 GND. wire x 1
		FA-0014-( <sup>L1</sup> )-( L2 )		TSC101-PS6		
F	Plug receptacle Fiber-code Assembly	FA-0009-( <sup>L1</sup> )-( L2 )	OPS2404-PR	TFC106-PS6		
		FA-0015-( <sup>L1</sup> )-( L2 )		TSC101-PS6		
● OPC series To OPS series						
	Plug - Jack Multi-cable Assembly	FB-0078-( <sup>L</sup> )-BK BK	OPC129-J-BK	OPS2403-J-BK	2SM-9.2-37.5 (φ 9.2)	With Boots and Caps
		FB-0079-( <sup>L</sup> )-BK BK	OPC128-P-BK	OPS2401-P-BK	2SM-9.2-37.5 (φ 9.2)	

Note : Colour rings of plug and jack are optional from the table below. Add resister colour code in ( <sup>c</sup> ).

Colour (Plug-Jack)	Red - Blue	Red - Green	Green - Red	Red - Black	Green - Black	Black - Black
Code No.	RB	RG	GR	RBK	GBK	BK BK

Note : Add register cable length in ( <sup>L</sup> ) or ( <sup>L1</sup> ), ( <sup>L2</sup> ).

ex. FA-0010-M100-RB (Cable Length=100m)

FA-0008-300-600 (Fiber cord Length=300mm, Lead wire Length=600mm)



[ D ] Plug-Jack Cable Assembly  
FW-0001-(<sup>L</sup>)-GR



[ F ] Plug Receptacle Cable Assembly  
FA-0009-(<sup>L1</sup>)-( <sup>L2</sup> )

[ E ] Receptacle Cable Assembly  
FA-0008-(<sup>L1</sup>)-( <sup>L2</sup> )

# Optical Fiber Cord with Single-fiber Connectors / Adapters

## SC, FC Connectors

### ■ Features

- Optical connector(s) is attached on both ends or either end of cords so as to be used for wiring or jumper connection in devices.
- A variety of connectors can be assembled to cord, nylon core and ribbon fiber in accordance with your requirement.



SC Connector Patch Cord

### ■ Models

Patch Cord Order No. : FA(1)Z(2)-(1)Z(2)-(3)-(4)(5)

1	Connector Type	SC FC	SC Connector FC Connector
2	Polishing Method	R2 AD	R20PC AdPC
3	Cable Length (mm)		
4	Fiber Type	SA GI	Single Mode Multi Mode (50/125)
5	Cord Type	2 3	PVC Sheath Diameter 2.0mm PVC Sheath Diameter 2.8mm



FC Connector Patch Cord

### ■ Specifications

Items		Multi mode fiber	Single mode fiber
Insertion Loss		Max : 0.3dB	Max. 0.5dB
Return Loss	PC-polishing	Min. 25dB	Min. 25dB
	AdPC-polishing	-----	Min. 42dB
Durability	500times	Deviation Max.0.2dB	Deviation Max.0.2dB
Temperature Cycling	-10°C to 60°C	Deviation Max.0.2dB	Deviation Max.0.2dB



SC Adapter  
TSC103-A2



FC Adapter  
TFC107-A2

A variety of connectors can be assembled to cord, nylon core and ribbon fiber in accordance with your requirement.

## Multi-pin Fiber Connectors

### Customized Products

### ■ Features

- Available in multi-pin fiber connectors from 2 to 12 pins for optical connection and optic hybrid connector for your special requirement.



Optical Connector / 6pins, Screw on, Waterproof



Optical Connector / 12pins, Push-pull Lock, Waterproof

# 50Ω/75Ω BNC Coaxial Connectors

## BNC series

- BNC series connectors are most widely used as 50 Ω coaxial connectors. This model is small and light, and its easy-to-use bayonet lock system is preferable for equipment that requires frequent connection and disconnection. 75 Ω type is recommendable for application with a frequency over 200 MHz used on 75 Ω transmission line.



Plug (Solder Type)  
BNC117-P



Receptacle  
BNC-R



Isolated Adapter  
BNC323-BA



Isolated Receptacle  
BNC284-BR



T-Type Adapter  
BNC-TA-JPJ



U-Link Adapter  
BNC153-A1



Plug (Crimp Type)  
BNC730-P



Printed Circuit Receptacle  
BNC223-R



Termination Plug  
BNC769-TP75



Plug (Solder Type)  
BNC732-P

### ● Panel Mount Receptacle

Part No.		Configuration
50 Ω Type	75 Ω Type	
BNC-R	BNC704-R	Flange Mount Jack Receptacle
BNC123-BR	BNC707-BR1	Bulkhead Mount Jack Receptacle
BNC223-R	BNC766-R	Printed Circuit Jack Receptacle
BNC284-BR	BNC782-BR	Isolated Jack Receptacle
BNC224-LR	BNC767-LR	Printed Circuit Right Angle Recep.

### ● Right Angle Cable Plug (Solder Type)

Part No.	Type	Clamp Style	Cable
BNC-LP-55U	50 Ω	Standard Clamp	RG-55/U, 58/U
BNC-LP-3DV	50 Ω		3D-2V
BNC778-LP	75 Ω	Screw Chuck	3C-2V, 5C-2V

### ● Solder Type Cable Jack

Part No.	Type	Cable	Part No.	Type	Cable
BNC-J-55U	50 Ω	RG-55/U, 58/U	BNC787-J	75 Ω	3C-2V, 5C-2V 5C-FB

### ■ Specifications

Impedance	50 Ω or 75 Ω
Withstanding Voltage	AC1500V RMS
Insulation Resistance	1000M Ω min.
Contact Resistance	3m Ω Max.
Frequency Range / V.S.W.R.	50 Ω : 0 - 4 GHz / 1.3 Max 75 Ω : 0 - 2.4GHz / 1.2 Max
Shell Material / Finish	Brass/Silver or Nickel
Contact Material	Brass or Beryllium Copper
Contact Finish	Silver or Gold
Insulator Material	PTFE
Gasket Material	Silicone Rubber

### ■ Models

#### ● Solder Type Cable Plug

Part No.	Type	Clamp Style	Cable
BNC-P-55U	50 Ω	Standard Clamp	RG-55/U, 58/U
BNC-P-59U	50 Ω		RG-59/U, 62/U
BNC9024-P	50 Ω		1.5D-2V, RG-188A/U
BNC-P-2.5DV	50 Ω		2.5D-2V
3CV-P	50 Ω	Screw Chuck	RG-141A/U
3CV-P2	50 Ω		RG-223/U
BNC772-P	75 Ω		2.5C-2V
BNC777-P	75 Ω		3C-2V, 5C-2V, 5C-FB
BNC756-P	75 Ω		6C-HD
BNC732-P	75 Ω		7C-2V, 7C-FB
BNC275-P1	50 Ω	Screw Chuck	5D-2V, 5C-2V
BNC278-P1	50 Ω		RG-55/U, 55B/U
BNC278-P4	75 Ω		RG-58/U, 58B/U, 58C/U

#### ● Crimp Type Cable Plug

Part No.	Type	Crimp Tool	Cable
BNC549-P	50Ω	DCC-T0297/T0298	RG-58A/U, 58C/U
BNC532-P	50Ω	CWB-T0105/T0106	3D-2V
BNC534-P	50Ω	CWB-T0297/T0298	5D-2V
BNC791-P	75Ω	CWB-T0265/T0266	RG-187A/U
BNC730-P	75Ω	CWB-T0095/T0096	RG-59B/U
BNC753-P-1	75Ω	CWB-T0105/T0106	3C-2V
BNC755-P-1	75Ω		5C-2V

#### ● Adapter

Part No.		Configuration
50 Ω Type	75 Ω Type	
BNC-A-JJ	BNC717-A	Jack to Jack Straight
BNC-TA-JPJ	-----	J-P-J T Type
BNC153-A1	-----	U-Link
BNC9057-A	-----	Plug(Slide-On) to Jack Straight
BNC-PA-JJ	BNC728-PA	Jack to Jack Flange Mount Straight
BNC-LA-PJ	BNC789-LA	Plug to Jack Right Angle
BNC323-BA	BNC779-BA	Isolated Jack to Jack Bulkhead

#### ● Termination

Part No.	Configuration
BNC174-TP	50 Ω
BNC769-TP75	75 Ω

# Push-Pull Type BNC Coaxial Connectors

## BNCS series



75Ω Crimp Type Plug BNCS705-P(°)



75Ω Solder Type Plug BNCS707-P(°)



50Ω Crimp Type Plug BNCS502-P(°)



75Ω Termination BNCS793-TP4-1

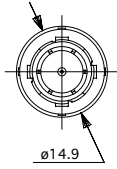

BNCS705-P(°)

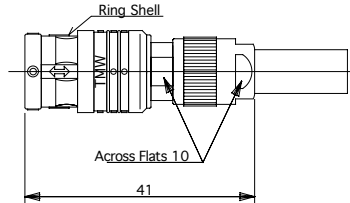
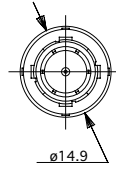
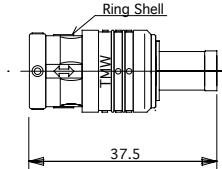

BNCS707-P(°)

### Features

- BNCS series connectors were developed by Tajimi Electronics based on its advanced high frequency technology this and unique design is compatible with BNC connectors. With the introduction of one touch engaging system instead of the conventional bayonet system, now you can use the BNC connectors that are used for a variety of applications as universal coaxial connectors with a single pull or push motion.
- BNCS connectors can be connected and disconnected with a single push and pull motion different from conventional BNC connectors that requires twisting motion.
- Equivalent connection strength to conventional BNC, realized by innovative rotary mechanism.
- Quick and reliable PUSH-PULL LOCK connection suitable for dense panel, fast installation and frequent connection and removal.
- Available in eight body colors and for easy identification.

### Specifications

Contents / Series	BNCS500 series	BNCS700 series
Impedance	50 Ω	75 Ω
Withstanding Voltage	AC1500V RMS	
Insulation Resistance	1000M Ω min.	
Contact Resistance	5m Ω Max.	
Frequency Range V.S.W.R.	0 - 4GHz / 1.3Max	0 - 2.4GHz / 1.2Max
Ring Shell Material	Nylon 66 UL94-HB	
Shell Material	Brass	
Shell Finish	Nickel	
Contact Material	Brass	
Contact Finish	Gold over Nickel	
Insulator Material	PTFE	



Crimp Tool



Stripping Tool for Coaxial Cable

### Models

#### ● Crimp Type Cable Plug

Type	Part No.	Cable	Crimp Tool
50 Ω	BNCS501-P(°)	3D-2V	CWB-T0297/T0298
50 Ω	BNCS502-P(°)	RG-58/U, RG-58A/U	
75 Ω	BNCS701-P(°)	3C-2V	CWB-T0105/T0106
75 Ω	BNCS702-P(°)	5C-2V	
75 Ω	BNCS703-P(°)	5C-FB	
75 Ω	BNCS704-P(°)	2.5C-2V	CWB-T0231/T0232
75 Ω	BNCS705-P(°)	RG-59/U, RG-59B/U	CWB-T0095/T0096
75 Ω	BNCS708-P(°)	1.5C-2V, RG-187A/U	CWB-T0265/T0266
75 Ω	BNCS709-P(°)	S-4C-FB	CWB-T0095/T0096

#### ● Solder Type Cable Plug

Type	Part No.	Cable
75 Ω	BNCS707-P(C)	3C-2V, 5C-2V, 5C-FB
75 Ω	BNCS710-P(C)	RG-59/U, RG-59B/U

#### ● Termination

Type	Part No.	Description
50 Ω	BNCS592-TP9	
50 Ω	BNCS593-TP9-1	With String
75 Ω	BNCS792-TP4	
75 Ω	BNCS793-TP4-1	With String

Note : Add register colour code in (°).

Colour	Black	Brown	Red	Yellow	Green	Blue	Gray	White
Code No.	0	1	2	4	5	6	8	9

# Push / Pull Type BNC Coaxial Connectors

## BNCS series

### ■ Cable Assembly

#### ● Patch Cables

Part No.	Cable	Connectors	Termination
CA18021CK-(L)-18-(C)	3D-2V	BNCS501-P	Crimp Type
CA18014LH-(L)-18-(C)	RG-58C/U	BNCS501-P	
CA18001AN-(L)-18-(C)	3C-2V	BNCS701-P	
CA18002AX-(L)-18-(C)	5C-2V	BNCS702-P	
CA18003DM-(L)-18-(C)	5C-FB	BNCS703-P	
CA18020LL-(L)-18-(C)	RG-59B/U	BNCS705-P	
CA18018GC-(L)-18-(C)	1.5C-QEV	BNCS708-P	
CA18010SAM-(L)-18-(C)	MOGAMI 2964	BNCS762-P	
CA18005AN-(L)-18-(C)	3C-2V	BNCS707-P	Solder Type
CA18015SAM-(L)-18-(C)	MOGAMI 2964	BNCS761-P	



Multicore Cable Assembly  
CA18012SAP-M10-18 (10m)

Note : Add register cable length in (L) by units of metric and body colour in (C). ex: CA18001AN-5000-18-0 indicates 5m and black  
In case over 10 meter, refer to the following example. ex: CA18001AN-M20-18-6 indicates 20m and blue

#### ● Multicore Cable Assemblies

Part No.	Configuration	Cable Part No.	Cable O.D.	Connectors	Termination
CA18024SAR-(L)-18	3 Core Type	MOGAMI 3156-00	φ14.0	BNCS761-P	Solder Type
CA18012SAP-(L)-18	4 Core Type	MOGAMI 3157-00	φ15.5		
CA18013SAQ-(L)-18	5 Core Type	MOGAMI 3158-00	φ17.5		

## Video Patch Plugs

### V series

### ■ Features

- They are true 75Ω video plugs, DC through 1.5GHz frequency range at a V.S.W.R. of less than 1.2 .

### ■ Specifications

Impedance	75 Ω
Withstanding Voltage	AC1500V RMS
Insulation Resistance	DC1000V 2000M Ω min.
Contact Resistance	5m Ω max.
Frequency Range / V.S.W.R.	0 - 1.5GHz / 1.2 max.
Shell Material/Finish	Brass / Nickel
Contact Material	Brass
Contact Finish	Gold over Nickel
Insulator Material	PTFE



Crimp Type Cable Plug  
V114-P5



Solder Type Cable Plug  
V117-P0

### ■ Models

#### ● Crimp Type Cable Plug

Part No.	Cable	Crimp Tool
V114-P(C)	3C-2V	CWB-T0105/T0106
V115-P(C)	5C-2V	

#### ● Solder Type Cable Plug

Part No.	Cable	Remarks
V117-P0	3C-2V, 5C-2V	Boot Colour: Black

#### ● Cable Assembly Models

Part No.	Connector	Cable
CA10007AN-(L)-10	V114-P0 x 2	3C-2V

Note : Add register cable length in (L) .

Note : Add register colour code in (C).

Colour	Black	Brown	Red	Orange	Yellow	Green	Blue	Gray	White
Code No.	0	1	2	3	4	5	6	8	9



# Water Proof BNC Connectors

## BNCW series

### ■ Features

- BNCW series connectors have the tight water mechanism by TAJIMI based on its original technology and are compatible with all BNC connectors.
- They are manufactured to meet IP65 and IP67 protection.
- Our recommendable receptacle: Bulkhead mount receptacle with waterproof panel attachment.
- The boots are available in nine colors and easily identifiable by color.

### ■ Specifications

Impedance	50 Ω	75 Ω
Connections	Bayonet Lock (Compatible BNC)	
Voltage Rating	AC500 V RMS	
Withstanding Voltage	AC1500 V RMS	
Insulation Resistance	1000M Ω min. at DC500V	
Contact Resistance	5m Ω Max.	
Frequency Range / V.S.W.R.	0 - 4GHz / 1.3 Max.	0 - 2.4GHz / 1.2 Max.
Water Proof	Water Resistance (IP65 / IP67)	
Max. Cable Retension Force for Maintaing Water Proof	49N (5kgf) Max.	
Durability	500 cycles	



Plug (Special Water Proof Type)  
BNCW501-P1-0

Plug (Normal Type)  
BNCW705-P

### ■ Models

#### ● Crimp Type Cable Plug

Part No. Normal Type	Part No.*1 Special Type	Type	Cable	Crimp Tool	Recommendable Receptacle
BNCW501-P	BNCW501-P1-( <sup>°</sup> )	50 Ω	3D-2V	CWB-T0105/T0106	BNC123-BR4
BNCW502-P	BNCW502-P1-( <sup>°</sup> )	50 Ω	5D-2V	CWB-T0095/T0096	
BNCW701-P	BNCW701-P1-( <sup>°</sup> )	75 Ω	3C-2V	CWB-T0105/T0106	BNC794-BR
BNCW705-P	BNCW705-P1-( <sup>°</sup> )	75 Ω	RG59B/U	CWB-T0095/T0096	

Note : \*1Special water proof type is a reinforced product with shrinking tube and boot for water proof of cable attachment.  
Boot's color of special water proof type is optional from the table below. Add register color code in (<sup>°</sup>).

Colour	Black	Brown	Red	Orange	Yellow	Green	Blue	Gray	White
Code No.	0	1	2	3	4	5	6	8	9

# Water Proof Coaxial Connectors

## PW series

- PW series connectors are tight waterproofing mechanism allows the model to be at a depth 30 meters under water.

### ■ Specifications

Connections	Screw Coupling
Withstanding Voltage	AC1500V RMS
Insulation Resistance	2000MΩ min.
Contact Resistance	5m Ω Max.
Water Proof	300kPa ( 3kgf/cm <sup>2</sup> )



Plug  
PW104-P



Jack  
PW108-J



Bulkhead Receptacle  
PW102-R

### ■ Models

#### ● Cable Plug

Part No.	Cable
PW101-P	3C-2V
PW104-P	5C-2V
PW107-P	RG-142B/U
PW120-P	3D-2V
PW121-P	5C-2W
PW129-P	RG-59/U,59A/U,59B/U
PW130-P	5D-2V

#### ● Cable Jack

Part No.	Cable
PW108-J	3C-2V
PW126-J	RG-142B/U
PW131-J	RG-59/U,59A/U,59B/U

#### ● Panel Mount Receptacle

Part No.	Description
PW102-R	Gasket
PW106-R	O-ring
PW9003-R	Hermetic Seal

# SMA Series Connectors

## TMA series

- TMA Series connectors are SMA type connectors that are designed to meet the requirement of MIL-C-39012 and IEC60169-15 compliance. They feature high performance with stable transmission characteristics in the range spanning from DC to 18GHz.

### ■ Specifications

Connections	1/4-36UNS-2A,2B
Withstanding Voltage	AC750 to 1500V RMS
Insulation Resistance	DC500V 5000M $\Omega$ min.
Contact Resistance	3m $\Omega$ Max
Impedance	50 $\Omega$
Frequency Range	0 -18GHz or 0 -12.4GHz
V.S.W.R.	1.15+0.02f -1.05+0.0085f(f=GHz)
Shell Material	Stainless Steel
Shell Finish	Gold or Passivating
Contact Material	Brass or Beryllium Copper
Contact Finish	Gold over Nickel
Insulator Material	PTFE
Gasket Material	Silicone Rubber



### ■ Models

#### ● Cable Plug and Jack

Part No.	Configuration	Cable
TMA3101-( )	Cable plug	RG-142B/U
TMA3201-( )	Right Angle Plug	223/U, 400/U
TMA3102-( )	Cable plug	RG-58C/U
TMA3202-( )	Right Angle Plug	141A/U, 303/U
TMA3103-( )	Cable plug	RG-174/U
TMA3203-( )	Right Angle Plug	188A/U, 316/U

#### ● Panel Mount Receptacle

Part No.	Configuration
TMA5101-( )	Flange Mount Jack Receptacle, Solder Pot Terminal
TMA5105-( )	Flange Mount Jack Receptacle, Straight Terminal
TMA5106-( )	Flange Mount Jack Receptacle, Straight Terminal
TMA5118-( )	Flange Mount Jack Receptacle, Straight Terminal
TMA5201-( )	Flange Mount Plug Receptacle, Solder Pot Terminal
TMA5401-( )	Right Angle Flange Mount Jack Receptacle, Solder Pot Terminal
TMA5402-( )	Right Angle Flange Mount Jack Receptacle, Straight Terminal
TMA5501-10	Straight Jack For Printed Circuit Boards
TMA5504-10	Right Angle Jack For Printed Circuit Boards
TMA5407-( )	Right Angle Flange Mount Jack Receptacle, Straight Terminal
TMA5408-( )	Right Angle Flange Mount Jack Receptacle, Straight Terminal

Note : Surface treatment is optional from the following table. Add register code in (°).

Surface Treatment	Gold Plating	Passivating
Code No.	10	20

### ■ ■ Semi-Rigid Coaxial Cable Assemblies ■ ■

- Semi-Rigid Coaxial Cable Assemblies provide for a low cost, high reliability and short lead time by innovative manufacturing line.

### ■ Construction



Standard Cable	Cable Plug	Right Angle Plug	Panel Mount Cable Jack
.141-inch Semi-rigid Cable	TMA1101-10 TMA1101-20	TMA1201-10 TMA1201-20	TMA2301-10 TMA2303-20
.085-inch Semi-rigid Cable	TMA1104-10 TMA1104-20	TMA1202-10 TMA1202-20	TMA2302-10 TMA2304-20
SC-160 type Semi-rigid Cable	TMA1108-10 TMA1108-20	TMA1203-10 TMA1203-20	TMA2306-10 TMA2311-20



# SMA Series Connectors

## TMA series

### ■ Super Semi-Rigid Coaxial Cable Assemblies ■

- Super Semi-Rigid Cable features ultra flexibility allows you to bend it easily yourself.

### ■ Models

Cable	Part No.	Connector Part No.	
Belden 1673A Conformable Coax Cable .141-inch Semi-rigid Cable Type	CA40089SQ-(L)-40-1	TMA1101-10	TMA1101-10
	CA40089SQ-(L)-40-2	TMA1101-20	TMA1101-20
	CA40090SQ-(L)-40-1	TMA1101-10	TMA1201-10
	CA40090SQ-(L)-40-2	TMA1101-20	TMA1201-20
	CA40091SQ-(L)-40-1	TMA1201-10	TMA1201-10
	CA40091SQ-(L)-40-2	TMA1201-20	TMA1201-20
Belden 1671A Conformable Coax Cable .085-inch Semi-rigid Cable Type	CA40047SAA-(L)-40-1	TMA1104-10	TMA1104-10
	CA40047SAA-(L)-40-2	TMA1104-20	TMA1104-20
	CA40048SAA-(L)-40-1	TMA1104-10	TMA1202-10
	CA40048SAA-(L)-40-2	TMA1104-20	TMA1202-20
	CA40049SAA-(L)-40-1	TMA1202-10	TMA1202-10
	CA40049SAA-(L)-40-2	TMA1202-20	TMA1202-20



Super Semi-Rigid Cable Assemblies

Note : Add register cable length in (L). ex. CA40047SAA-300-40-1 (Cable Length=300mm)

# SSMA Series Connectors

## SSMA series

- SSMA connectors have been designed to meet the requirements of MIL-C-39012 and IEC60169-18 compliance. TAJIMI's SSMA series can operate with excellent electrical characteristics at all frequencies up to 35GHz.

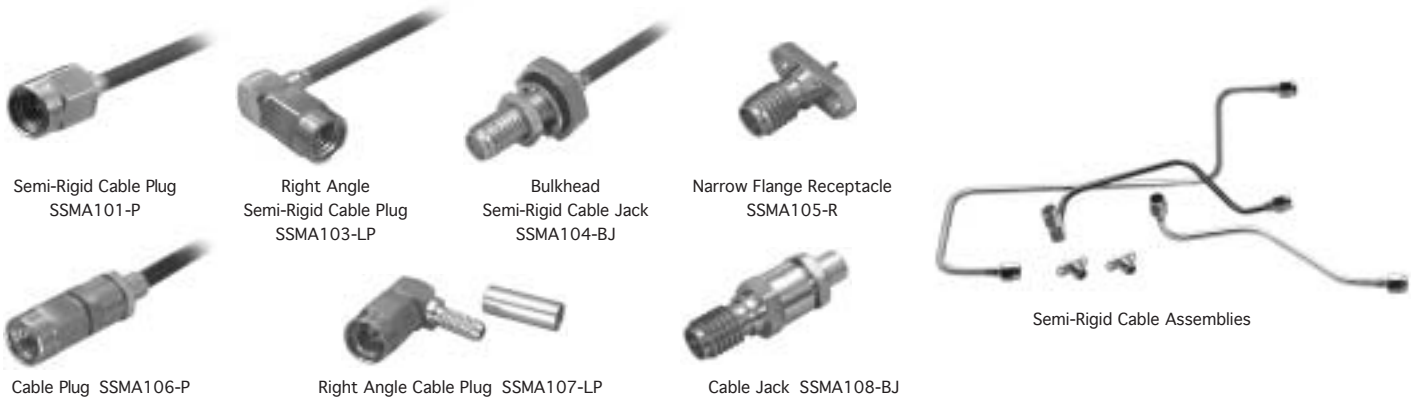

Semi-Rigid Cable Assemblies

### ● Specifications

Connections	#10-36UNS-2A,2B
Withstanding Voltage	AC750V RMS
Insulation Resistance	DC500V 1000MΩ min.
Contact Resistance	4mΩ Max.
Frequency Range	0 - 35GHz
Impedance	50Ω
V.S.W.R.	1.1+0.01f to 1.05+0.005f(f=GHz)
Shell Material	Stainless Steel
Shell Finish	Gold or Passivating
Contact Material	Brass or Beryllium Copper
Contact Finish	Gold over Nickel
Insulator Material	PTFE
Gasket Material	Silicone Rubber

### ● Models

Part No.	Configuration	Cable
SSMA101-P	Cable Plug	RG-405/U (.085)
SSMA102-P	Cable Plug	
SSMA103-LP	Right Angle Plug	
SSMA104-BJ	Bulkhead Mount Cable Jack	
SSMA105-R	2-Hole Flange Mount Jack Receptacle	
SSMA106-P	Cable Plug	RG-174/U 188A/U, 316/U
SSMA107-LP	Right Angle Plug	
SSMA108-J	Cable Jack	

# Triaxial Connectors for TV Camera

## MPX series

- Triaxial connectors are triple-layered with an additional insulation shield for enhancing the shielding effect of a coaxial connector. The external conductor inside is insulated from the equipment resulting in effective noise protection and remarkable improvement of cross talk.

### ■ Specifications

Contents / Series	MPX Series
Connections	Push-Pull
Withstanding Voltage	Contact to Contact AC3500V RMS, Body to Contact AC2000V RMS
Insulation Resistance	DC500V 1000MΩ min.
Contact Resistance	5mΩ Max.
Frequency Range	DC to 1.5GHz
Nominal Impedance	75Ω
V.S.W.R.	1.2 Max
Shell Material / Finish	Stainless Steel / Nickel
Contact Material / Finish	Brass or Beryllium Copper / Gold over Nickel
Insulator Material	PTFE
Gasket Material	Chloroprene or Silicone Rubber
Use	TV Camera System in Japan

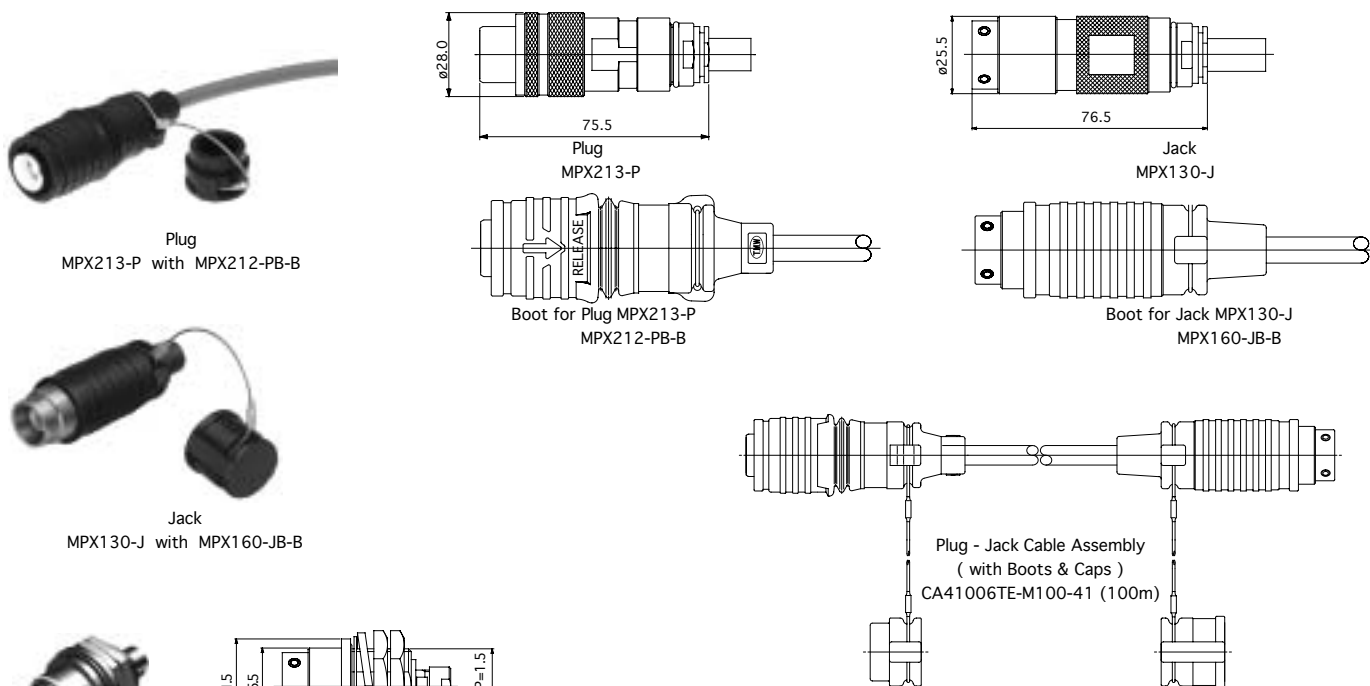

### ■ Models

Part No.	Configuration	Cable
MPX213-P	Cable Plug	4.8/1.0EFTXF
MPX130-J	Cable Jack	
MPX137-PP	Panel Mount Cable Plug	
MPX138-PJ	Panel Mount Cable Jack	9.6/2.2EFTXF
MPX131-P	Cable Plug	
MPX133-J	Cable Jack	
MPX178-PP	Panel Mount Cable Plug	4.8/1.0EFTXF, 5C-2V
MPX177-PJ	Panel Mount Cable Jack	
MPX122-BR1	Bulkhead Mount Jack Receptacle	2.5C-2V
MPX122-BR2		2.5C-2V
MPX124-PBR1	Bulkhead Mount Plug Receptacle	4.8/1.0EFTXF, 5C-2V
MPX124-PBR2		2.5C-2V

# Triaxial Connectors, MIL-C-49142 TRB/TRC Compliance

TXA series / TXE series / MCX series

- Triaxial connectors are triple-layered with an additional insulation shield for enhancing the shielding effect of a coaxial connector. The external conductor inside is insulated from the equipment resulting in effective noise protection and remarkable improvement of cross talk.
- TXA and TXE series are high performance products that are specifically for use where “Noise Free Guarded Systems”.

## ■ Specifications

Contents / Series	TXA Series	TXE Series	MCX Series
Specifications	MIL-C-49142 / series TRB	-----	MIL-C-49142 / series TRC
Connections	Miniature 3 lug, Bayonet	Miniature 2 lug, Bayonet	Miniature 2 lug, Bayonet
Withstanding Voltage	AC500V RMS		AC1500Vr RMS
Insulation Resistance	1000M $\Omega$ min.		1000M $\Omega$ min.
Contact Resistance	3m $\Omega$ Max.		
Frequency Range	0 -500MHz		0 -600MHz
Nominal Impedance	Non-Constant		
Shell Material / Finish	Brass / Nickel		
Contact Material / Finish	Brass or Beryllium Copper / Gold over Nickel		
Insulator Material	PTFE		
Gasket Material	Chloroprene or Silicone Rubber		
Use	Measuring Instruments		Communication Apparatus

## ■ ■ TXA series ■ ■



## ■ ■ TXE series ■ ■



## ■ ■ MCX series ■ ■



## ■ Models

Part No.	Configuration
TXA114-P1	Cable Plug
TXA102-BR	Bulkhead Mount Jack Receptacle
TXA103-PBR	Bulkhead Mount Plug Receptacle
TXA109-BJ	Bulkhead Mount Cable Jack
TXA105-PA	Jack to Jack Adapter Flange Mount
TXA107-BA	Jack to Jack Adapter BH Mount
TXA-RC	Protective Cap (with chain & loop)
AD9032-A	TXA Jack to BNC Plug Adapter
AD9034-A	TXA Plug to BNC Jack Adapter

- Cable : ECX1.5D-2VSV, ECX1.5C-2VSV, ECX2.5D-2VSV, ECX2.5C-2VSV

## ■ Models

Part No.	Configuration
TXE101-P	Cable Plug
TXE102-R	Receptacle
TXE103-BJ	Bulkhead Mount Cable Jack
TXE106-A	Adapter
TXE111-PA	Jack to Jack Adapter Panel Mount

- Cable : ECX1.5D-2VSV, ECX1.5C-2VSV, ECX2.5D-2VSV, ECX2.5C-2VSV

## ■ Models

Part No.	Configuration
MCX101-P	Cable Plug
MCX102-J	Jack
MCX106-BR	Bulkhead Mount Receptacle

- Cable : 4.8/1.0EFTXF

- We also available for BNCX series with 2 stud bayonet lock system that can be connected with BNC connectors. ( Internal blade is floated.) They are not compatible with TXE series.

# Miniature Coaxial Connectors for Piezoelectric Sensors

C25 series / C29 series / TMG series

- C25, C29 and TMG series are miniature coaxial connectors. Superior in vibration, impact, and noise, ideal for signal transmission for piezoelectric sensors.

## ■ Specifications

Contents / Series	C25 Series	C29 Series	TMG Series
Connections	#10-32UNF-2A,2B	JIS M3 (P=0.5)	JIS M2 (P=0.4)
Withstanding Voltage	AC500V RMS	AC250V RMS	AC200V RMS
Insulation Resistance	DC250V 1000M Ω min.	DC100V 5000M Ω min.	DC50V 1000M Ω min.
Contact Resistance	5m Ω Max.	6m Ω Max.	5m Ω Max.
Frequency Range	0 - 200MHz		
Normal Impedance	Non-constant		
Temperature Range	-50°C to +150°C or -25°C to +85°C		
Shell Material / Finish	Brass or Titanium / Nickel or Gold over Nickel		
Contact Material / Finish	Brass or Beryllium Copper / Gold Nickel		
Insulator Material	PTFE	PTFE or TI Polymer	
Gasket Material	Chloroprene or Silicone Rubber		

## ■ C25 series ■



### ● Cable Plug

Part No.	Cable	OD.max. (mm)	Length max.(mm)
C25-102P	RG-174/U,188A/U,316/U	6.0	23.0
C25-111P	DFL020,DFL021(Low Noise)	6.0	23.0
C25-144P		6.0	23.0
C29-104P	DFL005(Low Noise)	3.6	11.0
TMG108-P		2.6	6.9

## ■ C29 series ■



### ● Panel Mount Receptacle

Part No.	Configuration
C25-103BR	#10-32UNF-2A
C25-104BR	Bulkhead Mount Jack Receptacle
C29-113R	
C25-120R	Straight Jack for Printed Circuit Boards
C25-117LR	Right Angle Jack Printed Circuit Boards
C29-103R	Panel Feedthrough Jack Receptacle
TMG107-R	

## ■ TMG series ■



## ■ MR01 series / Multi-Pin Micro Connectors ■

- MR01 series connectors are very small multi-pin circular connectors designed especially for pickups applied to a variety of miniature sensors. These connectors are built compact, light, and vibration- and impact-resistant to be applicable to sensors that are increasing performance and growing smaller based on modern technologies.

- Small and light, giving the least load to a sensor. ● Plugs are provided as part of a cable assembly.

## ■ Specifications

Contents / Series	MR01 Series
Voltage Rating	AC50V Max.
Current Rating	0.5A Max.
Withstanding Voltage	AC150V RMS
Insulation Resistance	DC50V 1000M Ω min.
Contact Resistance	30mΩ Max.
Vibration	10 to 2000Hz 10G
Shock	500G
Temperature Range	-25°C to +85°C
Shell Material / Finish	Brass or Stainless Steel / Nickel or Passivating
Contact Material / Finish	Phosphor Bronze or Beryllium Copper / Gold over Nickel
Insulator Material	PPS

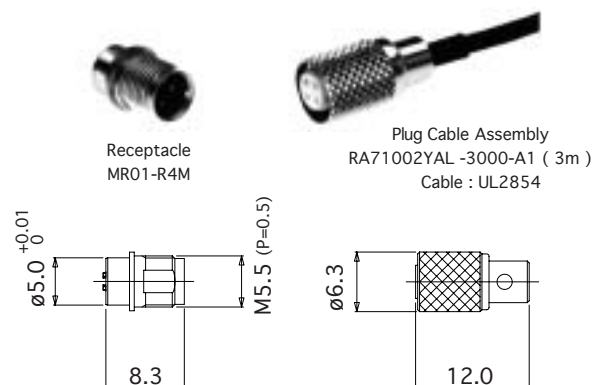

# Subminiature Coaxial Connectors

SMB series / SMC series / C33 series

- These connectors are equivalent to SMB and SMC type connectors that qualified to MIL-C-39012 and IEC60169-9,10 compliance.
- They are subminiature in size, also applicable for the printed circuit. 1322 and 1324 series are available in 75Ω .

## ■ 1321 series / SMC type ■



Plug  
1321-001P



Bulkhead Receptacle  
1321-005BR



Right Angle Receptacle  
1321-102LR

## ■ 1322 series / Screw on 75Ω type ■



Right Angle Plug  
1322-013LP



Right Angle Receptacle  
1322-102LR

## ■ 1323 series / SMB type ■



Plug  
1323-001P



Bulkhead Receptacle  
1323-004BR



Right Angle Receptacle  
1323-102LR

## ■ 1324 series / Snap on 75Ω type ■



Right Angle Plug  
1324-011LP



Bulkhead Receptacle  
1324-004BR

## ■ C33 series / Snap on 50Ω type ■



Plug  
C33-111P



Right Angle Receptacle  
C33-114LR

## ■ Specifications

Contents / Series	1321 series	1322 series
Specifications	MIL-C-39012 / Series SMC	-----
Connections	Screw Coupling	
Nominal Impedance	50Ω	75Ω
Frequency Range / V.S.W.R.	0 -1GHz / 1.2 Max.	
Withstanding Voltage	AC1500V RMS	
Insuration Resistance	DC500V 1000MΩ min.	
Contact Resistance	6m Ω Max.	
Dimension (mm) Plug O.D. max.	φ 6.7mm	φ 9.8mm

Contents / Series	1323 series	1324 series
Specifications	MIL-C-39012 / Series SMB	-----
Connections	Snap on	
Nominal Impedance	50Ω	75Ω
Frequency Range / V.S.W.R.	0 -1GHz / 1.2 Max.	
Withstanding Voltage	AC1500V RMS	
Insuration Resistance	DC500V 1000MΩ min.	
Contact Resistance	6mΩ Max.	
Dimension (mm) Plug O.D. max.	φ 6.4mm	φ 9.2mm

Contents / Series	C33 series
Connections	Snap on
Nominal Impedance	50Ω
Frequency Range / V.S.W.R.	0 -1GHz / 1.2 max.
Withstanding Voltage	AC300V RMS
Insuration Resistance	DC250V 1000MΩ min.
Contact Resistance	10mΩ Max.
Dimension (mm) Plug O.D. max.	φ 3.5mm

# High-Voltage Type Coaxial Connectors

MHV series / SHV series / HN series

## ■ MHV series ■



Receptacle  
UG-931/U



Plug (Solder Type)  
UG-932/U

## ■ Specifications

Specifications	MIL-C-39012 Compliance
Connections	Bayonet Lock
Nominal Impedance	Non-Constant
Voltage Rating	AC 1500V RMS
Withstanding Voltage	AC 5000V RMS (connected state)
Insulation Resistance	DC 500V 1000M $\Omega$ min.
Contact Resistance	15m $\Omega$ Max.
Dimension (mm)	Plug O.D. $\phi$ 14.5mm

## ■ SHV series ■



Receptacle  
SHV103-R



Plug (Crimp Type)  
SHV111-P

Specifications	MIL-C-39012 Compliance
Connections	Bayonet Lock
Nominal Impedance	Non-Constant
Voltage Rating	AC 1500V RMS
Withstanding Voltage	AC 5000V RMS (connected state)
Insulation Resistance	DC 500V 1000M $\Omega$ min.
Contact Resistance	3m $\Omega$ Max.
Dimension (mm)	Plug O.D. $\phi$ 14.5mm

## ■ HN series ■



Receptacle  
HN-R



Plug (Solder Type)  
HN-P-8U

Specifications	MIL-C-3643, JIS, NDS, DSP Compliance
Connections	Screw on
Nominal Impedance	50 $\Omega$
Frequency Range / V.S.W.R.	0 -3GHz / 1.2 Max.(to 2GHz)
Withstanding Voltage	AC5000V RMS (connected state)
Insulation Resistance	DC500V 1000M $\Omega$ min.
Contact Resistance	3m $\Omega$ Max.
Dimension (mm)	Plug O.D. $\phi$ 22.0mm



# Coaxial Connectors

TNC series / UHFseries / N series / C series

## ■ TNC series ■



Receptacle  
TNC114-BR



Plug (Solder Type)  
TNC-P-55U

## ■ Specifications

Specifications	MIL-C-39012 Compliance
Connections	Screw Coupling
Nominal Impedance	50 Ω
Frequency Range / V.S.W.R.	0 - 11GHz / 1.2 Max(to 4GHz)
Withstanding Voltage	AC1500V RMS
Insuration Resistance	DC500V 5000M Ω min.
Contact Resistance	3m Ω Max.
Dimension (mm)	Plug O.D. max. φ14.5mm

## ■ UHFseries ■



Receptacle  
N-Rinche



Plug (Solder Type)  
M-P-8U

Specifications	MIL
Connections	Screw Coupling
Nominal Impedance	Non-Constant
Frequency Range	0 - 200MHz
Withstanding Voltage	AC1000V RMS
Insuration Resistance	DC500V 1000M Ω min.
Contact Resistance	3m Ω Max.
Dimension (mm)	Plug O.D. φ19.0mm

## ■ N series ■



Receptacle  
N-R



Plug (SolderType)  
N-P-8U

Specifications	MIL-C-39012 Compliance
Connections	Screw Coupling
Nominal Impedance	50 Ω or 75 Ω
Frequency Range / V.S.W.R.	0 - 10 GHz / 1.2 Max.(to 4GHz)
Withstanding Voltage	AC1500V RMS
Insuration Resistance	DC500V 2000M Ω min.
Contact Resistance	3m Ω mMax.
Dimension (mm)	Plug O.D. max. φ 20mm

## ■ C series ■



Receptacle  
C-R



Plug (Solder Type)  
C-P-8U

Specifications	MIL-C-39012 Compliance
Connections	Bayonet Lock
Nominal Impedance	50 Ω
Frequency Range / V.S.W.R.	0 - 10GHz / 1.2 Max.(to 4GHz)
Withstanding Voltage	AC4000V RMS
Insuration Resistance	DC1000V 2000M Ω min.
Contact Resistance	3m Ω Max.
Dimension (mm)	Plug O.D. φ19.1mm

# Between Series Coaxial Adapters

## AD series

### ■ Features

- AD series are connectors for coaxial to coaxial connectors and coaxial to triaxial connectors.
- Also available not only the part numbers below but also a wide variety of products.

### ■ Models



Adapter  
NP-BNCJ-A



Adapter  
AD269-A



Adapter  
BNCJ-1323P-A



Adapter  
NJ-BNCJ-PA



Adapter  
AD9034-A

Construction	Adapter Ends	Part No.	Description	
N to BNC	N-Plug	BNC-Plug	NP-BNCP-A	Straight
		BNC-Jack	NP-BNCJ-A	Straight
N to M		M-Plug	NP-MP-A	Straight
		M-Jack	NP-MJ-A	Straight
N to HN		HN-Jack	NP-HNJ-A	Straight
N to TNC		TNC-Plug	NP-TNCP-A	Straight
		TNC-Jack	NP-TNCJ-A	Straight
N to SMA		SMA-Jack	AD268-PA	For Panel Attachment
		SMA-Jack	AD269-A	Straight
N to BNC		N-Jack	BNC-Plug	NJ-BNCP-A
	BNC-Jack		NJ-BNCJ-A	Straight
N to M	M-Plug		NJ-MP-A	Straight
	M-Jack		NJ-MJ-A	Straight
N to HN	HN-plug		NJ-HNP-A	Straight
	HN-Jack		NJ-HNJ-A	Straight
N to TNC	TNC-Plug		NJ-TNCP-A	Straight
	TNC-Jack		NJ-TNCJ-A	Straight
N to SMA	SMA-Plug		AD266-BA-1	For Panel Attachment
	SMA-Jack		AD265-BA-1	For Panel Attachment
BNC to M	BNC-Plug	M-Plug	BNCP-MP-A	Straight
		M-Jack	BNCP-MJ-A	Straight
BNC to HN		HN-Jack	BNCP-HNJ-A	Straight
		TNC-Plug	BNCP-TNCP-A	Straight
BNC to TNC		TNC-Jack	BNCP-TNCJ-A	Straight
		BNC to TXA	TXA-Jack	AD216-A
AD243-A				Floated External Cond.
AD9032-A				Floated Internal Cond.
BNC to SMA		SMA-Jack	BNCP-TMAJ-A	Straight
BNC to SMB		SMB-Jack	BNCP-1323J-A	Straight
BNC to SMC	SMC-Jack	BNCP-1321J-A	Straight	
BNC to C25	C25-Jack	BNCP-C25J-A	Straight	
BNC to M	BNC-Jack	M-Plug	BNCJ-MP-A	Straight
		M-Jack	BNCJ-MJ-A	Straight
BNC to HN		HN-plug	BNCJ-HNP-A	Straight
		HN-Jack	BNCJ-HNJ-A	Straight
BNC to TNC		TNC-Plug	BNCJ-TNCP-A	Straight
		TNC-Jack	BNCJ-TNCJ-A	Straight
BNC to TXA		TXA-Plug	AD215-A	Straight
			AD242-A	Floated External Cond.
			AD9034-A	Floated Internal Cond.
BNC to SMA		SMA-Jack	AD323-PA	For Panel Attachment
BNC to SMB	SMB-Plug	BNCJ-1323P-A	Straight	
BNC to SMC	SMB-Jack	AD284-PA	For Panel Attachment	
	SMC-Plug	BNCJ-1321P-A	Straight	
TNC to SMA	TNC-Plug	SMA-Plug	AD314-A	Straight
SMA-Jack		AD315-A	Straight	
TNC to SMB	SMB-Jack	AD337-PA-3	For Panel Attachment	
TNC to SMA	TNC-Jack	SMA-Plug	AD316-A	Straight
		SMA-Jack	AD324-PA	For Panel Attachment
TXA to SMA	TXA-Plug	SMA-Jack	AD294-A	Floated External Cond.
		SMA-Plug	AD330-A	Floated Internal Cond.
	TXA-Jack	SMA-Jack	AD309-PA	For Panel Attachment Floated Internal Cond.

# Water Proof Circular Connectors

## 1108 series

- 1108 series connectors are built compact and the tight waterproofing mechanism allows the model to be at a depth of 30 meter. This model is also ideal for application where units are exposed to extreme weather or high humidity either inside or outside.
- Also available in a hermetically sealed receptacle.

### Specifications

Connections	Screw Coupling
Termination	Solder
Temperature and Humidity	-25°C to +85°C 85% Max.
Number of Pins	2, 3, 4, 5, 7, 8, 12, 14, 19, 21, 37
Shell Material / Finish	Brass / Nickel
Contact Material / Finish	Copper Alloy / Gold over Nickel
Water Proof (Connected State)	300kPa ( 3kgf/cm <sup>2</sup> )
Hermetic Seal (Hermetically sealed recep. only)	Helium leak rate 1 ATM. 1x10 <sup>-9</sup> cc/sec Max.

\* See next page as for Electrical Specifications.



Plug / Normal Clamp Type  
1108-12A10-7M( )



Plug / Double Clamp Type  
1108-12B10-7M( )



Jack / Normal Clamp Type  
1108-32A10-7M( )



Plug / Normal Clamp with Long Body Type  
1108-15A10-7M( )



Bulkhead Mount Receptacle  
1108-23A10-7F



Flange Mount Receptacle  
1108-21B10-7F



Hermetically Sealed Receptacle  
1108-71B10-7M



Back Mount Receptacle  
1108-29B10-7M-1



Caps for Plug and Receptacle  
1108-10PC1, 1108-10RC

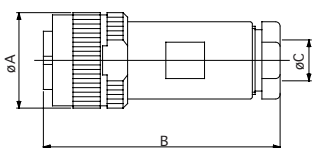

Plug / Normal Clamp Type

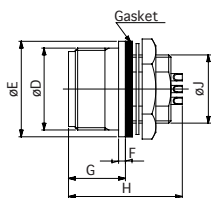

Bulkhead Mount Receptacle

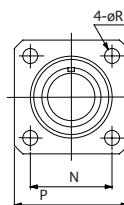

Flange Mount Receptacle

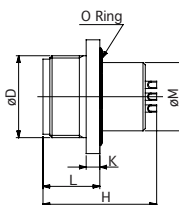

Jack

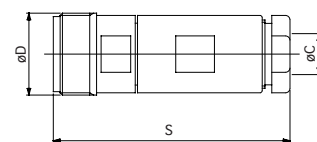

### Configuration

Insert size	No. of Pins	Dimensions (mm)																
		A	B	C		D	E	F	G	H	J	K	L	M	N	P	R	S
10	2, 3, 4 5, 7	21.0	52.0	5.0, 6.3, 7.0, 8.0	8.6, 9.3, 10.0, 10.5	M18 P=1	21.0	1.5	12.5	26.0	M15 P=1	3.0	12.5	15.0	18.0	25.0	3.2	52.0
16	8, 14	27.0	55.5	11.1, 11.8, 13.5		M24 P=1	27.0	1.5	12.5	26.0	21.0 P=1	3.0	12.5	21.0	23.0	30.0	3.2	56.0
20	12, 19	34.0	61.0	11.0, 14.3, 15.8		M30 P=1	33.0	2.0	13.5	26.0	26.0 P=1	3.0	12.5	26.0	31.0	38.0	3.2	61.0
26	21, 37	40.0	65.0	16.3		36.0 P=1	39.0	2.5	13.5	26.0	32.0 P=1	3.0	12.5	32.0	35.0	43.0	3.2	65.5

# Water Proof Circular Connectors Specifications

1108 series

## Part Numbering System

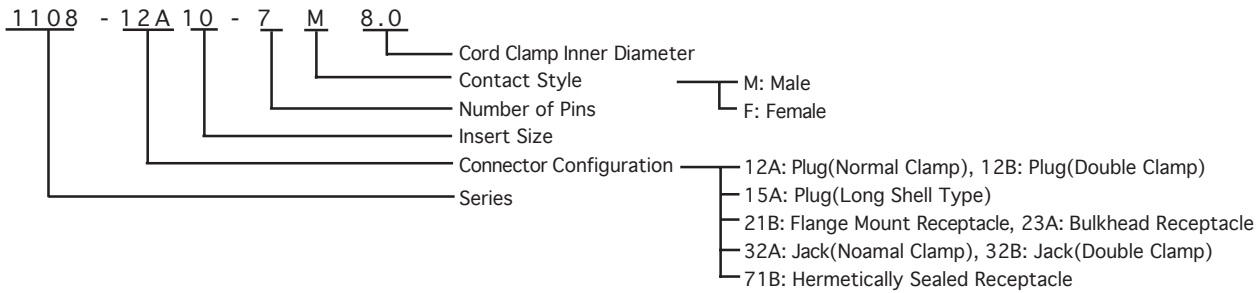

Insert Size	10				16		20		26		
Number of Contacts	2	3	4	5	7	8	14	12	19	21	37
Withstanding Voltage (V RMS)	1800	1000	1200	1000	900~1000	1200	1000	1200	1200	1200	1200
Voltage Rating (V RMS)	600	350	400	350	300~350	400	350	400	400	400	400
Current Rating (A)	10	10	5	5	5	10	5	10	4	10	3
Applicable Wire Size	16	16	20	20	20	16	20	16	20	16	20
Contact Resistance	5mΩ Max.										
Insulation Resistance	DC500V 1000MΩ~2000MΩ min.										

## Insert Size & Pin Arrangement

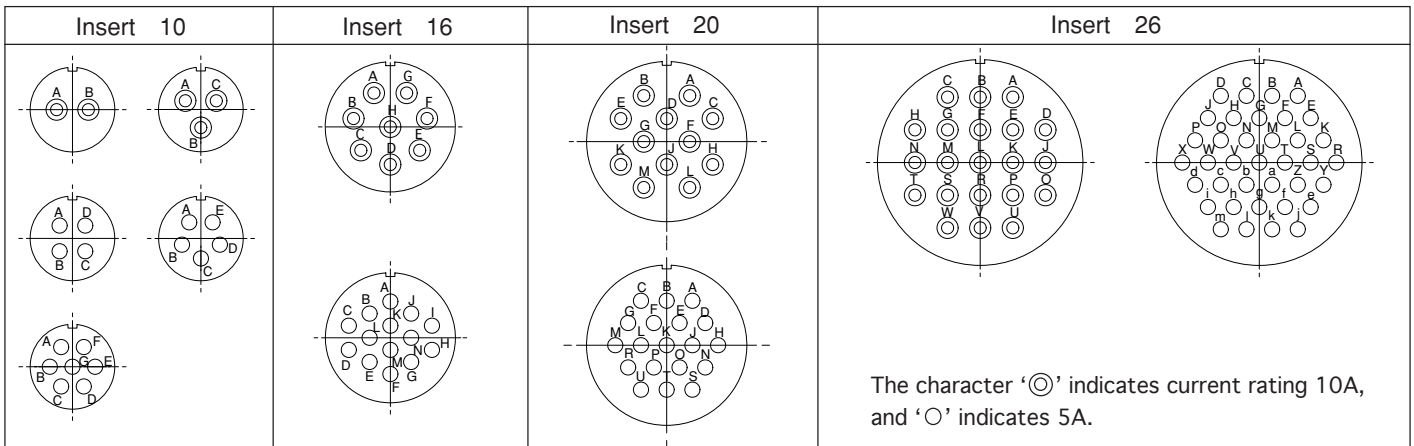

\* Drawings above are ones viewed from the rear side of pin insulators. (pin contacts)

## Mounting Hole Dimensions

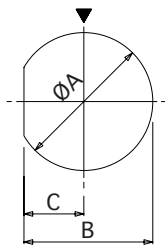

Style 1

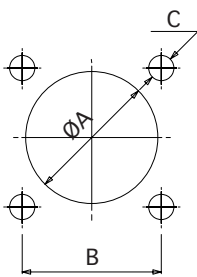

Style 2

### Bulkhead Mount Receptacle

Insert Size	Style	φ A	B	C
10	1	15.2	14.2	6.6
16		21.2	20.2	9.6
20		26.2	25.2	12.1
26		32.2	31.2	15.1

### Frange Mount Receptacle

Insert Size	Style	φ A	B	C
10	2	15.2	18.0	M3
16		21.2	23.0	M3
20		26.2	31.0	M3
26		32.2	35.0	M3

### Hermetically Sealed Receptacle

Insert Size	Style	φ A	B	C
10	2	14.8	18.0	M3
16		21.8	25.0	M3

# Water Proof Circular Connectors

R04 series / R28 series

- R04 series connectors are built compact and the tight waterproofing mechanism allows the model to be at a depth of 20 meters . This model is ideal for application where units are exposed to extreme weather or high humidity either inside or outside.

Also available in a hermetically sealed receptacle.

R28 series based on R04 series feature high density and miniaturization.

## Specifications

Series	R04	R28
Connections	Screw Coupling	
Termination	Solder	
Temperature and Humidity	-25°C to +85°C 85% Max.	
Number of Pins	2, 3, 5, 6, 8, 12	8, 12
Shell Material / Finish	Brass and Zinc Alloy / Nickel	
Contact Material / Finish	Copper Alloy / Gold over Nickel	
Insulation Material	PBT Resin (UL 94 V-0)	
Water Proof (connected state)	200kPa ( 2kgf/cm <sup>2</sup> )	
Hermetic Seal (Hermetically sealed recep. only)	Helium leak rate 1 ATM. 1x10 <sup>-9</sup> cc/sec max.	-----

\* See next page as for Electrical Specifications.



Plug  
R04-P8M

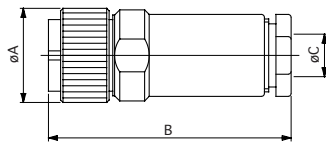

Jack  
R04-J8F6.3

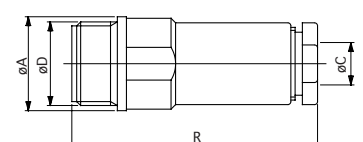

Bulkhead Mount Receptacle  
R04-R8F

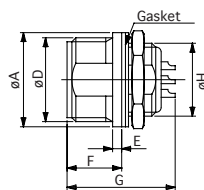

Hermetically Sealed Recep.  
R04-R2MHB  
(Only R04series )

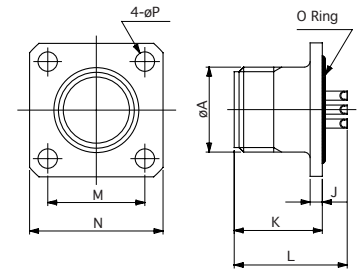

## Configuration

Series	Insert size	No. of Pins	Dimensions (mm)														
			A	B	C	D	E	F	G	H	J	K	L	M	N	P	R
R04	6	2, 3, 5	12.0	38.0	4.8	10.5 P=0.75	1.5	9.0	17.8	9.0 P=0.5	2.0	14.5	18.6	14.0	20.0	3.2	38.0
	9	6, 8	15.5	40.0	6.3, 6.8, 7.3	M14 P=1	1.5	9.0	17.8	12.0 P=0.8	2.0	14.5	18.6	16.0	22.0	3.2	40.5
	12	12	20.0	43.3	6.3, 8.5	M18 P=1	1.5	9.0	17.8	M16 P=1	3.0	14.5	18.6	20.0	26.0	3.2	41.8
R28	6	8	12.0	38.0	4.8	10.5 P=0.75	1.5	9.0	17.8	9.0 P=0.5	---	---	---	---	---	---	---
	9	12	15.5	40.0	6.3, 6.8, 7.3	M14 P=1	1.5	9.0	17.8	12.0 P=0.8	---	---	---	---	---	---	---

# Water Proof Circular Connectors

R04 series / R28 series

## Part Numbering System

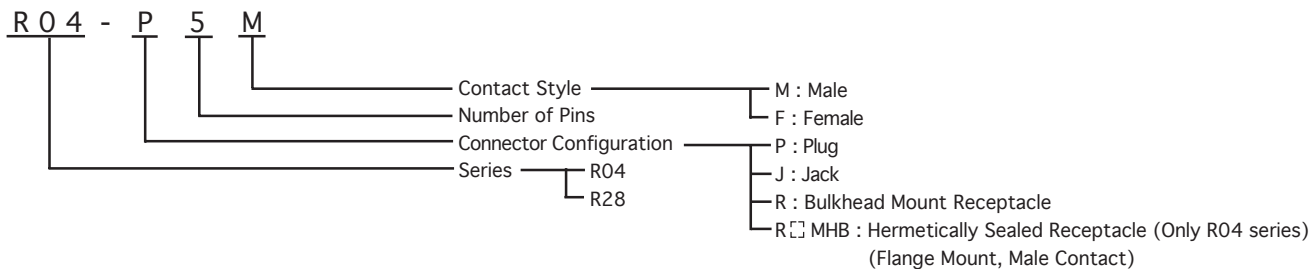

## Electrical Specifications

Series	R04						R28	
	6			9		12	6	9
Insert Size	6			9		12	6	9
Number of Contacts	2	3	5	6	8	12	8	12
Withstanding Voltage (V RMS)	900	900	500	900	700	900	300	300
Voltage Rating (V RMS)	300	300	150	300	200	300	100	100
Current Rating (A)	2							
Applicable Wire Size	AWG#24 (0.2mm <sup>2</sup> Max.)						AWG#26 (0.1mm <sup>2</sup> Max.)	
Contact Resistance	8mΩ Max.						15mΩ Max.	
Insulation Resistance	DC500V 1000MΩ min.						DC100V 1000MΩ min.	

## Insert Arrangement

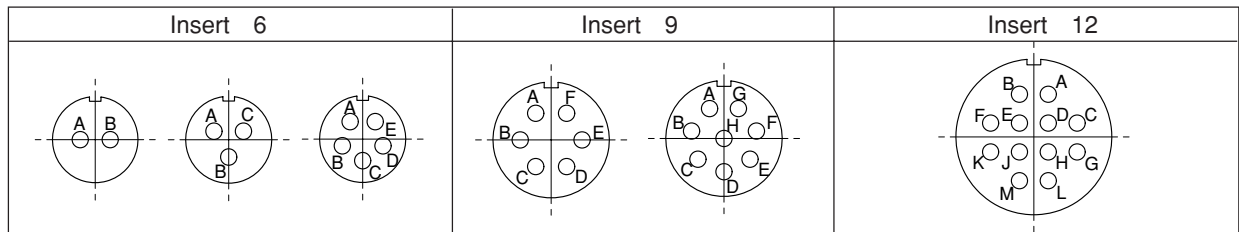

\* Drawings above are ones viewed from the rear side of pin insulators. (pin contacts)

## Mounting Hole Dimensions

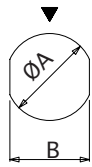

Style 1

### Bulkhead Mount Receptacle

Insert Size	Style	φA	B
6	1	9.2	8.4
9		12.2	11.2
12		16.2	14.7

\* R28 is not available in insert size 12.

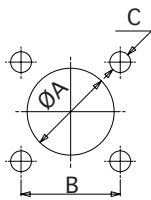

Style 2

### Hermetically Sealed Receptacle (Flange Mount, Only R04 series)

Insert Size	Style	φA	B	C
6	2	9.6	14.0	M3
9		12.4	16.0	M3
12		16.8	20.0	M3

# Water Proof Circular Connectors

## R14 series

■ R14 series connectors are the tight waterproofing mechanism allows the model to be at a depth of 100 meters under water.

Housing parts are made of stainless steel that is ideal to use under water.



Plug  
R14-P3F



Cap for Plug  
R14-10PC



Bulkhead Mount Receptacle  
R14-R3M



Cap for Receptacle  
R14-10RC

### ■ Specifications

Connections	Screw Coupling	
Applicable Cable	Cable O.D. $\phi 9.5$ to $\phi 10.0$	
Insulation Resistance	DC500V 1000M $\Omega$ Min	
Contact Resistance	5m $\Omega$ Max.	
Water Proof	Connected State Only Receptacle	1000kPa (10kgf/cm <sup>2</sup> ) 500kPa (5kgf/cm <sup>2</sup> )
Dimensions	Plug : O.D. $\phi 27.0$ mm / Length 68.5mm Receptacle : $\phi 28.0$ mm / Length 27.0mm	

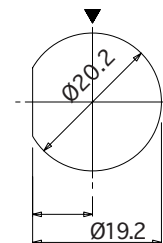

Mounting Hole Dimensions

### ■ Models

No. of Pins	Plug	Receptacle	Voltage Rating	Current Rating	Withstanding Voltage
2	R14-P2F	R14-R2M	600V RMS	10A	1800V RMS
3	R14-P3F	R14-R3M	350V RMS	10A	1000V RMS
4	R14-P4F	R14-R4M	400V RMS	5A	1200V RMS
5	R14-P5F	R14-R5M	350V RMS	5A	1000V RMS
7	R14-P7F	R14-R7M	300V RMS	5A	900V RMS

### ■ Pin Arrangement

For Pin Arrangement, see Insert 10 on P19.

# Push-Pull Circular Connectors

PRC03 series / PRC04 series

- PRC03 series Push-Pull Locking connectors are uniquely designed in applications and are popular in demand -ing measurement and industrial. PRC03 series connectors are registered as a standard model of Japanese Non-destructive Testing Association.

PRC04 series are lightweight connectors, adopting aluminum alloy.

## Specifications

Series	PRC03	PRC04
Connections	Push-Pull	
Termination	Solder	
Temperature and Humidity	-25°C to +85°C 85% Max.	
Number of Pins	2, 3, 4, 5, 7	8, 12, 14, 19, 21, 37
Shell Material / Finish	Zinc Alloy / Nickel	Aluminum Alloy / Anodic Oxidation
Contact Material / Finish	Copper Alloy / Gold over Nickel	

\* See next page as for Electrical Specifications.



Plug  
PRC03-12A10-3AM10.5

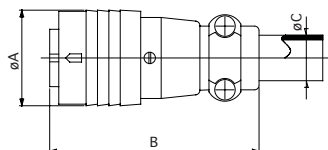

Jack  
PRC03-32A10-AF

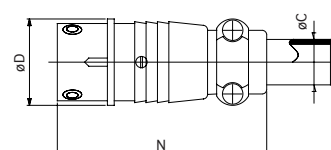

Bulkhead Mount Receptacle  
PRC03-23A10-3AF

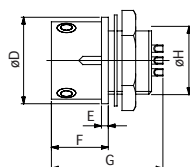

Flange Mount Receptacle  
PRC03-21A10-3AF

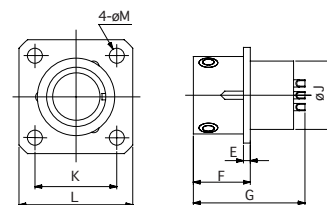

## Configuration

Insert Size	Series	No. of Pins	Dimensions (mm)													
			A	B	C	D	E	F	G	H	J	K	L	M	N	
10	PRC03	2, 3, 4, 5, 7	21.0	46.0	10.5	19.0	1.5	12.5	26.5	M15 P=1	15.0	16.0	21.0	2.9	46.0	
16	PRC04	8, 14	28.0	55.5	12.5	25.0	2.0	13.5	25.5	21.0 P=1	21.0	21.5	28.0	3.4	50.0	
20		12, 19	34.0	63.5	14.5	32.0	2.5	14.0	26.0	26.0 P=1	26.0	26.0	33.0	3.9	58.5	
26		21, 37	41.0	71.0	18.0	38.0	2.5	14.0	26.0	32.0 P=1	32.0	31.0	38.0	3.9	65.5	



# Push-Pull Circular Connectors Specifications

PRC03 series / PRC04 series

## Part Numbering System

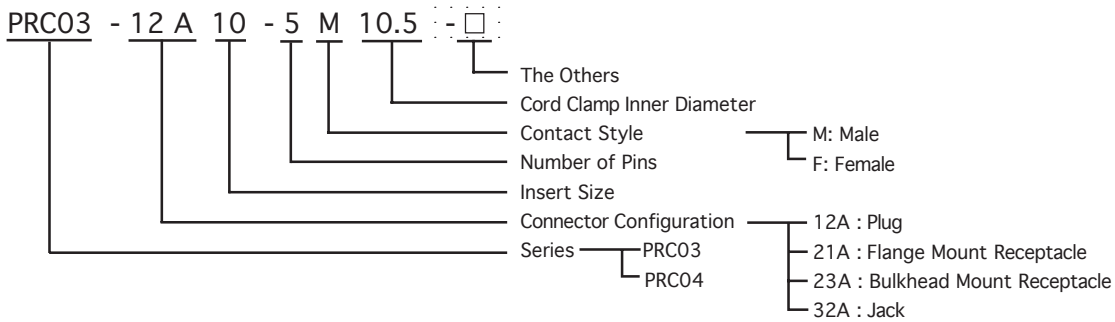

## Electrical Specifications

Series	PRC03					PRC04					
	10					16		20		26	
Insert Size	10					16		20		26	
Number of Contacts	2	3	4	5	7	8	14	12	19	21	37
Withstanding Voltage (V RMS)	1800	1000	1200	1000	1000	1200	1000	1200	1200	1200	1200
Voltage Rating (V RMS)	600	350	400	350	350	400	350	400	400	400	400
Current Rating (A)	10	10	5	5	5	10	5	10	4	10	3
Applicable Wire Size	AWG#16 (1.4mm <sup>2</sup> Max.)		AWG#20 (0.5mm <sup>2</sup> Max.)			AWG-#16	AWG-#20	AWG-#16	AWG-#20	AWG-#16	AWG-#20
Contact Resistance	5mΩ Max.										
Insulation Resistance	DC500V 100MΩ min.										

\* PRC03 series is only available in Insert Size 10, PRC04 series is only available Insert Size 16, 20 and 26.

## Insert Size & Pin Arrangement

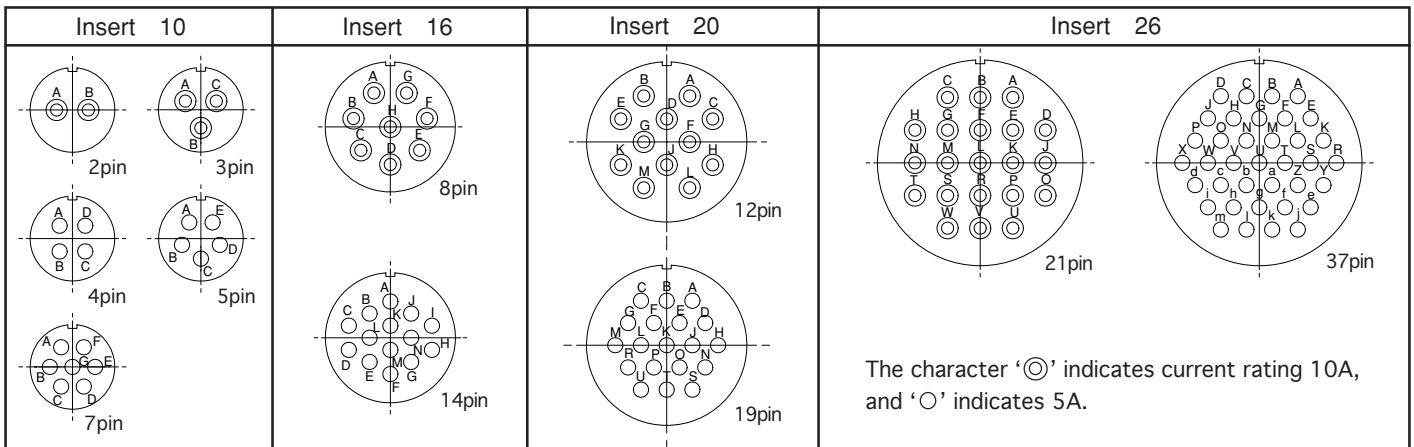

\* Drawings above are ones viewed from the rear side of pin insulators. (pin contacts)

## Mounting Hole Dimensions

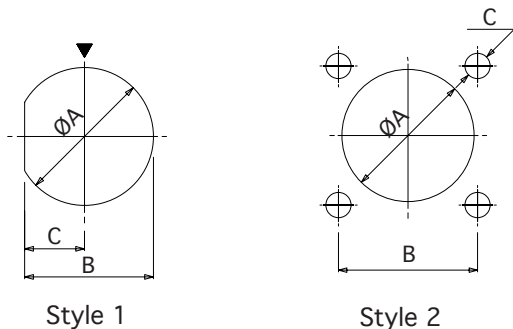

### Bulkhead Mount Receptacle

Insert Size	Style	φ A	B	C
10 : PRC03	1	15.2	14.2	6.6
16 : PRC04		21.2	20.2	9.6
20 : PRC04		26.2	25.2	12.1
26 : PRC04		32.2	31.2	15.1

### Flange Mount Receptacle

Insert Size	Style	φ A	B	C
10 : PRC03	2	15.2	16.0	φ 2.9
16 : PRC04		21.2	21.5	φ 3.4
20 : PRC04		26.2	26.0	φ 3.9
26 : PRC04		32.2	31.0	φ 3.9

# Push-Pull Circular Connectors

PRC05 series / PRC07 series

- PRC05 series are smaller than the PRC03, PRC04 series, they are our original Push-Pull Locking connectors for quick and easy connection.
- PRC07 series based on PRC05 series feature high density and miniaturization.

## Specifications

Connections	Push-Pull Lock
Termination	Solder
Temperature and Humidity	-25°C to +85°C 85% Max.
Number of Pins	2, 3, 5, 6, 8, 12
Shell Material / Finish	Brass / Nickel
Contact Material / Finish	Copper Alloy / Gold over Nickel

\* See page 28 as for Electrical Specifications.



Plug  
PRC05-PSF

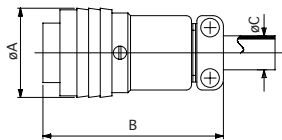

Jack  
PRC05-J5M

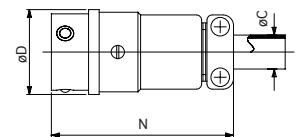

Bulkhead Mount Receptacle  
PRC05-R5M

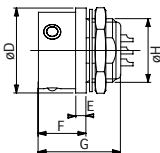

Flange Mount Receptacle  
PRC05-RB5M

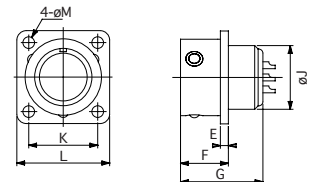

## Configuration

Insert Size	No. of Pins	Dimensions (mm)													
		A	B	C	D	E	F	G	H	J	K	L	M	N	
6	2, 3, 5	13.5	32.0	5.2	13.0	2.0	9.5	18.0	9.0 P=0.5	9.0	11.5	16.0	2.2	32.5	
9	6, 8	16.7	34.0	6.2	16.0	2.0	9.5	18.0	12.0 P=0.8	12.0	13.5	18.0	2.2	34.5	
12	12	21.0	39.0	11.0	20.0	2.0	9.5	18.0	M16 P=1.0	16.0	17.0	22.5	2.8	39.0	

# Miniature Circular Connectors

R03 series / R27 series

- R03 series are small circular connectors with threads on locking. They are subminiature in size and are suited for a variety of electronic equipment.
- A wide variety of molded cable assemblies are available for your requirement.
- R27 series based on R03 series feature high density and miniaturization.

## Specifications

Series	R05	R27
Connections	Screw Coupling	
Termination	Solder	
Temperature and Humidity	-25°C to +85°C 85% Max.	
Number of Pins	2, 3, 5, 6, 8, 12	8, 12
Shell Material / Finish	Brass and Zinc Alloy / Nickel	
Contact Material / Finish	Copper Alloy / Gold over Nickel	
Corrosion Resistance	Salt Spray 5% 48H	

\* See page 28 as for Electrical Specifications.

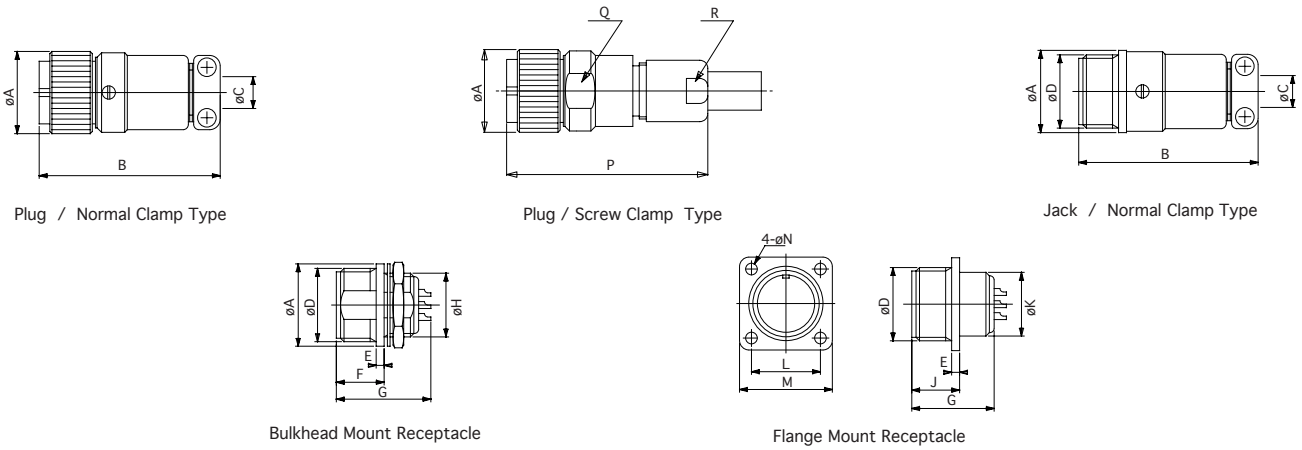
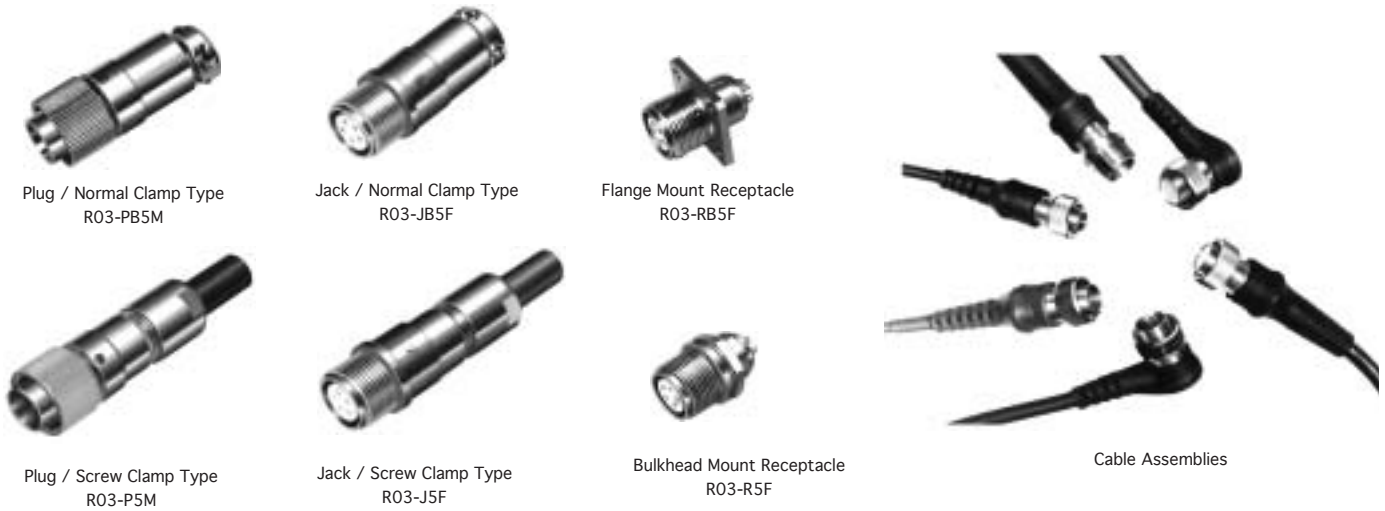

## Configuration

Series	Insert size	No. of Pins	Dimensions (mm)																
			A	B	C	D	E	F	G	H	J	K	L	M	N	P	Q	R	
R03	6	2, 3, 5	12.0	32.0	5.2	10.5 P=0.75	1.5	9.0	18.0	9.0 P=0.5	9.5	10.5	10.5	15.0	2.2	35.0	10.5	9.5	
	9	6, 8	15.5	34.0	6.2	M14 P=1	1.5	9.0	18.0	12.0 P=0.8	9.5	10.5	13.0	17.5	2.2	37.0	13.5	10.5	
	12	12	20.0	39.0	10.5	M18 P=1	1.5	9.0	18.0	M16 P=1	9.5	10.5	17.0	22.5	2.8	37.0	13.5	10.5	
R27	6	8	12.0	32.0	5.2	10.5 P=0.75	1.5	9.0	18.0	9.0 P=0.5	9.5	10.5	10.5	15.0	2.2	35.0	10.5	9.5	
	9	12	15.5	34.0	6.2	M14 P=1	1.5	9.0	18.0	12.0 P=0.8	9.5	10.5	13.0	17.5	2.2	37.0	13.5	10.5	

# Bayonet Miniature Circular Connectors

R05 series / R29 series

- R05 series are small circular connectors with bayonet lock system. They are subminiature in size and are suited for a variety of electronic equipment.
- A wide variety of molded cable assemblies are available for your requirement.
- R29 series based on R05 series feature high density and miniaturization.

## Specifications

Series	R05	R29
Connections	Bayonet Lock	
Termination	Solder	
Temperature and Humidity	-25°C to +85°C 85% Max.	
Number of Pins	2, 3, 5, 6, 8, 12	8, 12
Shell Material / Finish	Brass and Zinc Alloy / Nickel	
Contact Material / Finish	Copper Alloy / Gold over Nickel	
Corrosion Resistance	Salt Spray 5% 48h	

\* See page 28 as for Electrical Specifications.



Plug / Normal Clamp Type  
R05-PB5F



Jack / Normal Clamp Type  
R05-JB5M



Flange Mount Receptacle  
R05-RB5M



Bulkhead Mount Receptacle  
R05-R5M



Plug / Screw Clamp Type  
R05-P5F



Jack / Screw Clamp Type  
R05-J5M



Bulkhead Mount Receptacle for Printed Circuit  
R05-R5F2

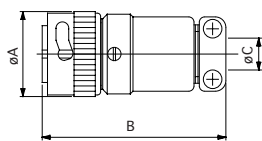

Plug / Normal Clamp Type

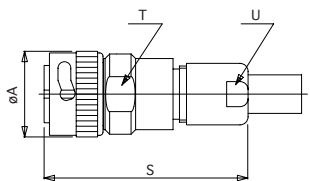

Plug / Screw Clamp Type

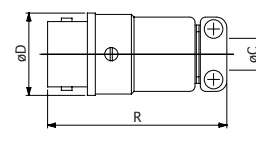

Jack / Normal Clamp Type

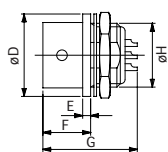

Bulkhead Mount Receptacle

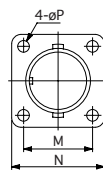

Flange Mount Receptacle

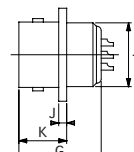

## Configuration

Series	Insert size	No. of Pins	Dimensions (mm)																	
			A	B	C	D	E	F	G	H	J	K	L	M	N	P	R	S	T	U
R05	6	2, 3, 5	13.0	32.5	5.2	12.0	2.0	9.5	18.0	9.0 P=0.5	1.5	10.5	9.0	10.5	15.0	2.2	32.0	35.5	10.5	9.5
	9	6, 8	16.0	34.5	6.2	15.5	2.0	9.5	18.0	12.0 P=0.8	1.5	10.5	12.0	13.0	17.5	2.2	34.0	38.0	13.5	10.5
	12	12	20.0	39.0	10.5	19.5	1.5	9.0	18.0	M16 P=1	1.5	10.5	16.0	17.0	22.5	2.8	39.0	38.0	13.5	10.5
R29	6	8	13.0	32.5	5.2	12.0	2.0	9.5	18.0	9.0 P=0.5	1.5	10.5	9.0	10.5	15.0	2.2	32.0	35.5	10.5	9.5
	9	12	16.0	34.5	6.2	15.5	2.0	9.5	18.0	12.0 P=0.8	1.5	10.5	12.0	13.0	17.5	2.2	34.0	38.0	13.5	10.5

# Miniature Circular Connectors Specifications

R03 series / R05 series / R27 series / R29 series / PRC05 series / PRC07 series

## Part Numbering System

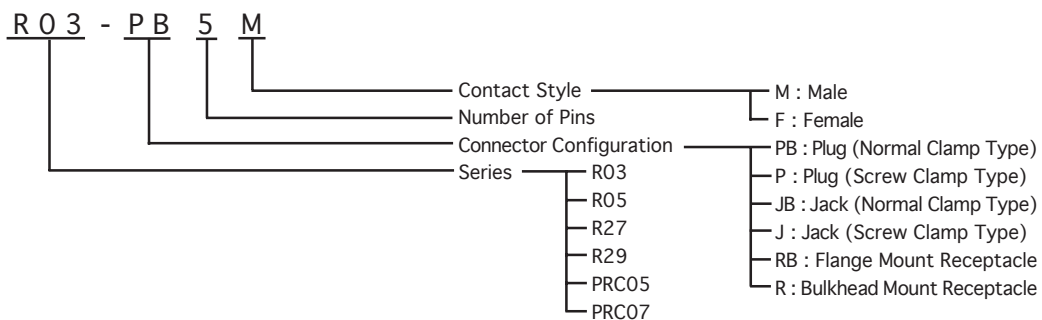

## Electrical Specifications

Series	R03, R05, PRC05						R27, R29, PRC07	
Insert Size	6			9		12	6	9
Number of Contacts	2	3	5	6	8	12	8	12
Withstanding Voltage (V RMS)	900	900	500	900	700	900	300	
Voltage Rating (V RMS)	300	300	150	300	200	300	100	
Current Rating (A)	2							
Applicable Wire Size	AWG#24 (0.2mm <sup>2</sup> Max.)						AWG#26 (0.1mm <sup>2</sup> Max.)	
Contact Resistance	8mΩ min.						10mΩ min.	
Insulation Resistance	DC500V 1000MΩ min.						DC100V 1000MΩ min.	

## Insert Arrangement

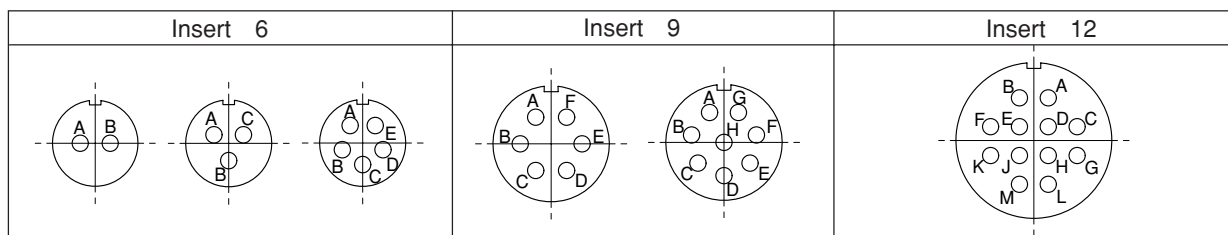

\* Drawings above are ones viewed from the rear side of pin insulators. (pin contacts)

## Mounting Hole Dimensions

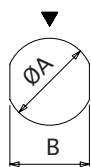

Style 1

### Bulkhead Mount Receptacle

Insert Size	Style	φA	B
6	1	9.2	8.4
9		12.2	11.2
12		16.2	14.7

\* R27, R29 and PRC07 are not available in insert size 12.

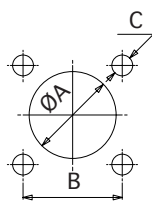

Style 2

### Flange Mount Receptacle

Insert Size	Style	φA	B	C
6	2	9.2	10.5	φ2.2
9		12.2	13.0	φ2.2
12		16.2	17.0	φ2.2

\* R27, R29 and PRC07 are not available in insert size 12.