

New product

MITSUBISHI LASER DIODES ML9XX2 SERIES

FOR OPTICAL COMMUNICATION

MITSUBISHI (DISCRETE SC) 3LE D ■ 6249829 0014206 5 ■ MITS

TYPE
NAME

ML9702, ML9912

T-41-05

DESCRIPTION

Mitsubishi ML9XX2 series are DFB laser diodes emitting light beams around 1550nm wavelength. They lase by applying forward current exceeding threshold values, and emit light power of about 5mW/facet at an operating current of around 25mA in excess of the threshold current. They operate, under CW or pulse conditions according to input current, at case temperatures up to 60°C.

The ML9702 are hermetically sealed devices having an InGaAs pin photodiode for monitoring the light output. Output current of the photodiode can be used for automatic control of the operating currents or case temperatures of the lasers.

The ML9912 are specially designed for installation in fiber modules and are mounted on flat open packages. Rear output can be used for automatic control of the operating current or case temperature of the laser. They are well suited for light sources in optical communication systems.

FEATURES

- Low threshold current typical 20mA
- High stable fundamental transverse mode oscillation
- High side mode suppression ratio typical 33dB ($T_C=5\sim 50^\circ\text{C}$)
- High speed of response (Rise and fall time typically 0.2nsec)

APPLICATION

Digital communication systems

ABSOLUTE MAXIMUM RATINGS

Symbol	Parameter	Conditions	Ratings	Unit
P_O	Light output	CW	6	mW
V_{RL}	Reverse voltage (Laser diode)	—	2	V
V_{RD}	Reverse voltage (Photodiode)	—	20	V
I_{FD}	Forward current (Photodiode)	—	2	mA
T_C	Case temperature	—	0~+60	°C
T_{stg}	Storage temperature	—	-40~+100	°C

ELECTRICAL/OPTICAL CHARACTERISTICS ($T_C=25^\circ\text{C}$)

Symbol	Parameter	Test conditions	Limits			Unit
			Min.	Typ.	Max.	
I_{th}	Threshold current	CW	—	20	40	mA
I_{OP}	Operating current	CW, $P_O=5\text{mW}$	—	45	90	mA
V_{OP}	Operating voltage (Laser diode)	CW, $P_O=5\text{mW}$	—	1.2	1.8	V
P_O	Light output	CW, $I_F=I_{th}+25\text{mA}$	3	5	—	mW
λ_P	Lasing wavelength	CW, $P_O=5\text{mW}$	1530	1550	1570	nm
$\theta_{//}$	Full angle at half maximum	CW, $P_O=5\text{mW}$	—	35	—	deg.
θ_{\perp}			—	40	—	deg.
I_m	Monitoring output current	CW, $P_O=5\text{mW}$ $V_{RD}=1\text{V}$ $R_L=10\Omega$ (Note 1)	0.1	0.5	—	mA
t_r/t_f	Rise and fall time	$I_F=I_{th}$, $P_O=5\text{mW}$, 10~90%	—	0.2	0.4	ns
SMSR	Side mode suppression ratio	CW, $P_O=5\text{mW}$, 5~50°C	25	33	—	dB
P_m (Note 2)	Monitoring light output	CW, $P_O=5\text{mW}$	0.3	1	—	mW

Note 1 : R_L is load resistance of the photodiode.

Note 2 : P_m only apply to ML9912.

ML9XX2 SERIES

MITSUBISHI (DISCRETE SC) 3LE D ■ 6249829 0014207 7 ■ MIT5

FOR OPTICAL COMMUNICATION

T-41-05

OUTLINE DRAWINGS

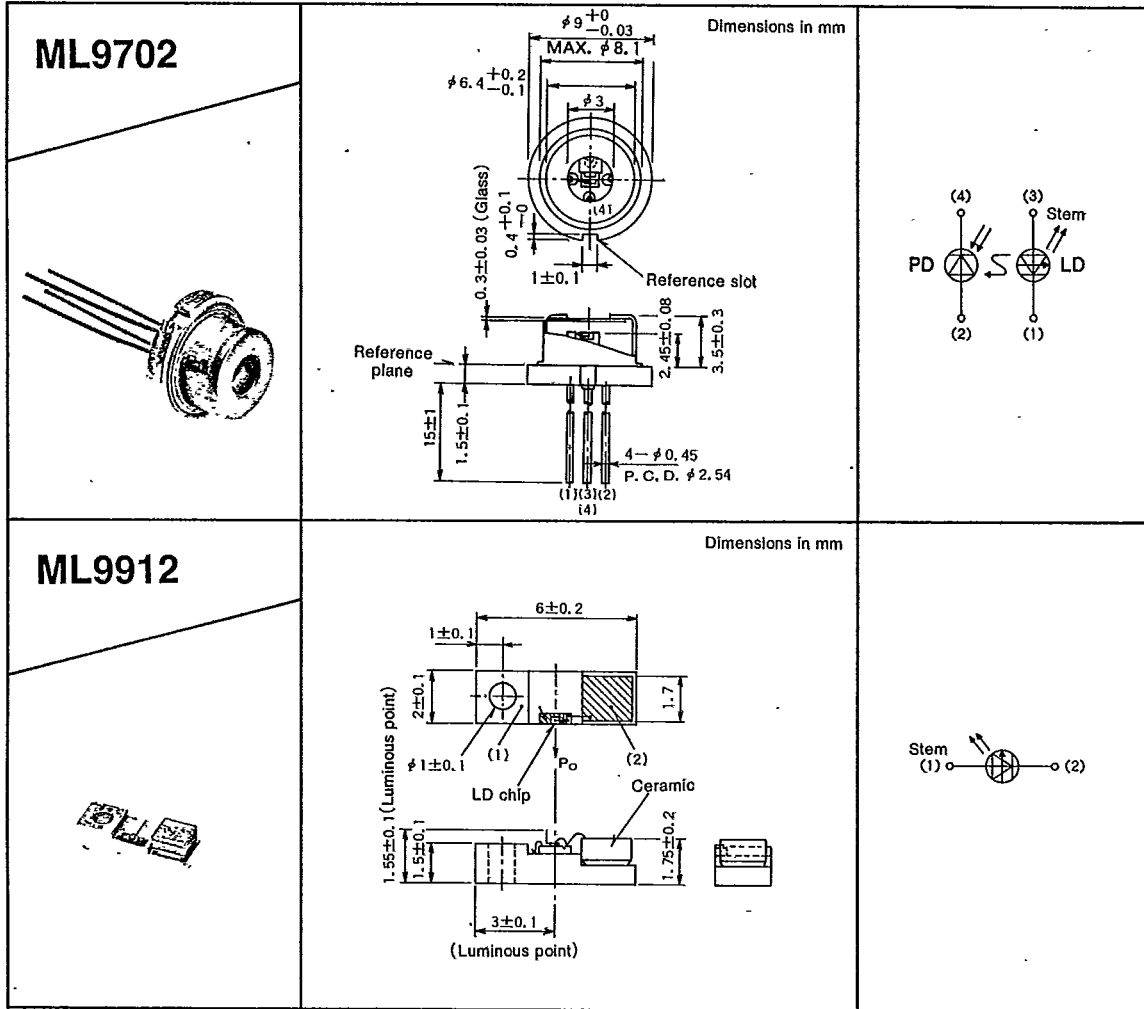

MITSUBISHI LASER DIODES
ML9XX2 SERIES

MITSUBISHI (DISCRETE SC) 3LE D ■ 6249829 0014208 9 ■ MITS
FOR OPTICAL COMMUNICATION

T-41-05

1 Light output vs. forward current

Typical light output vs. forward current characteristics are shown in Fig. 1. The threshold current for lasing is typically 20mA at room temperature. Above the threshold, the light output increases linearly with current, and no kinks are observed in the curves. As can be seen in Fig. 1, the threshold current and slope efficiency (dP_o/dI_f) depends on case temperature of the lasers. This suggests that automatic control of temperature or current is necessary to keep the light output constant since temperature variation is inevitable in practical systems. The automatic controls should be such that the maximum ratings for the light output and the case temperature are not exceeded. "OPERATING CONSIDERATIONS," gives an example of an automatic light output control circuit.

Fig. 1 Light output vs. forward current

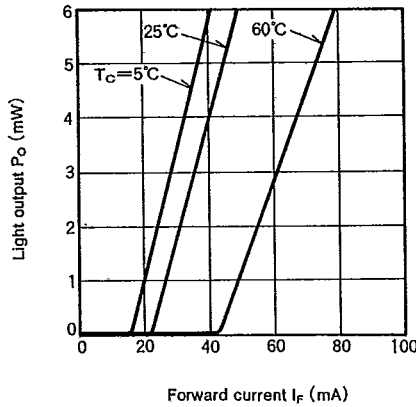

2 Temperature dependence of threshold current (I_{th}), operating current (I_{op}) and slope efficiency (η)

A typical temperature dependence of the threshold current and operating current is shown in Fig. 2. The characteristic temperature T_0 of the threshold current is typically 60k in $T_c \leq 40^\circ\text{C}$, 50k in $T_c > 40^\circ\text{C}$, where the definition of T_0 is $I_{th} \propto \exp(T_c/T_0)$.

Fig. 2 Temperature dependence of threshold current and operating current

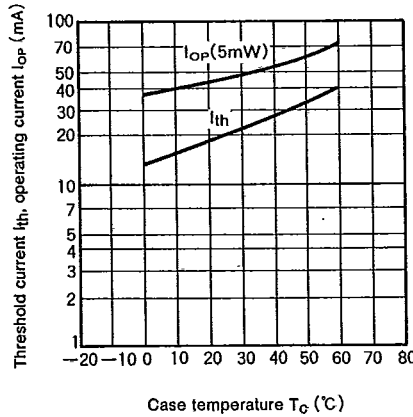

A typical temperature dependences of the slope efficiency η is shown in Fig. 3. The gradient is $-0.013\text{mW/mA}/^\circ\text{C}$.

Fig. 3 Temperature dependence of slope efficiency

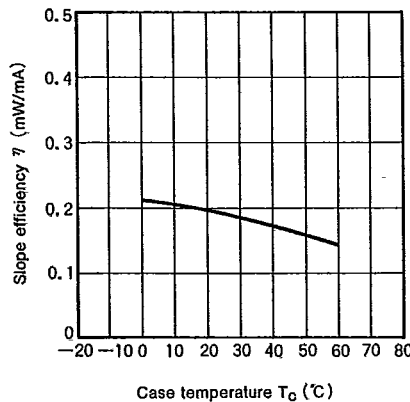

MITSUBISHI LASER DIODES
ML9XX2 SERIES

MITSUBISHI (DISCRETE SC) 3LE D 6249829 0014209 0 MITS
FOR OPTICAL COMMUNICATION

T-41-05

3 Forward current vs. voltage

Typical forward current vs. voltage characteristics are shown in Fig. 4. In general, as the case temperature rises, the forward voltage V_F decreases slightly against the constant current I_F . V_F varies typically at a rate of $-1.0\text{mV}/^\circ\text{C}$ at $I_F = 1\text{mA}$.

Fig. 4 Forward current vs. voltage characteristics

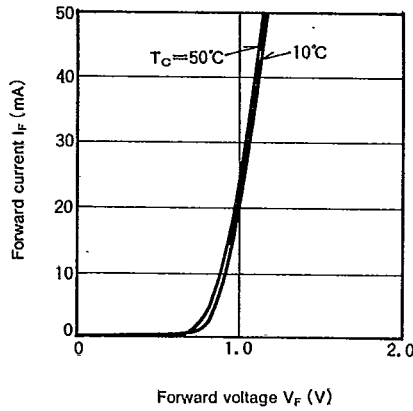

4 Emission spectra

Typical emission spectra under CW operation are shown in Fig. 5.

Fig. 5 Emission spectra under CW operation

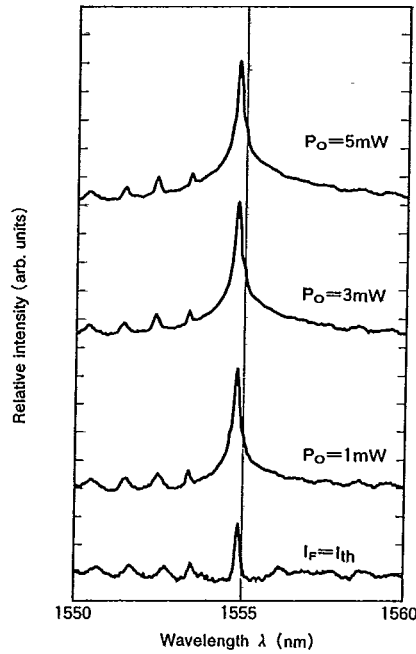

Emission spectrum under 2Gb/s (NRZ) modulation is shown in Fig. 6.

Typical spectral width (Chirping) is about 0.15nm at -3dB , 0.35nm at -10dB and 0.80nm at -20dB .

Fig. 6 Emission spectrum under modulated operation

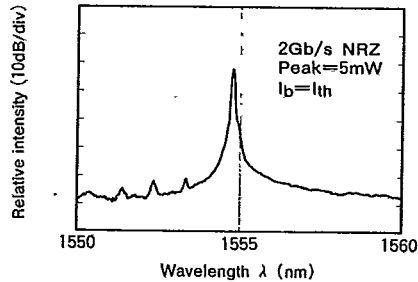

T-41-05

A typical temperature dependence of the peak wavelength at an output of 5mW is shown in Fig. 7.

The peak wavelength of the beam shifts and jumps to adjacent longitudinal mode by variation of operating temperature.

Averaged temperature coefficient which includes the shifts and jumps is about 0.08nm/°C.

Fig. 7 Temperature dependence of peak wavelength

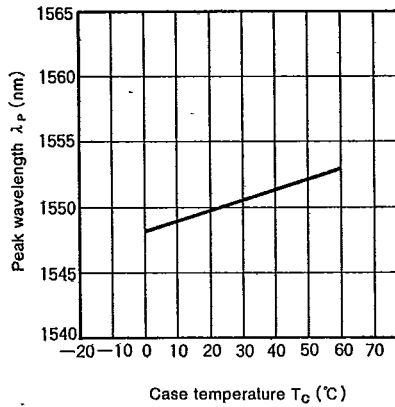

5 Far-field radiation pattern

The ML9XX2 laser diodes lase in fundamental transverse (TE_{00}) mode and the mode does not change with the current. They have a typical emitting area (size of near-field pattern) of $1.0 \times 1.25 \mu m^2$. Fig. 8 and Fig. 9 show typical far-field radiation patterns in "parallel" and "perpendicular" planes, respectively.

The full angles at half maximum points (FAHM) are typically 35° and 40° , respectively.

Fig. 8 Far-field patterns in plane parallel to heterojunctions

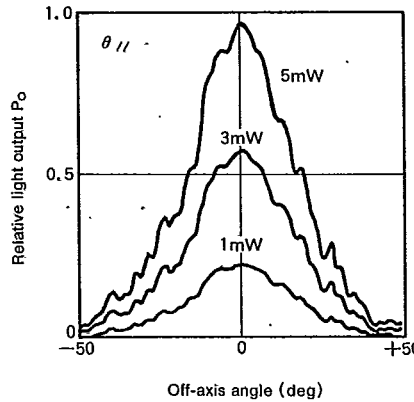
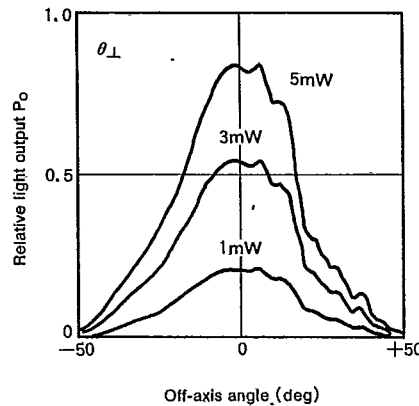

Fig. 9 Far-field patterns in plane perpendicular to heterojunctions



T-41-05

6 Pulse response

In digital optical transmission systems, the response waveform and speed of the light output against the input pulse current waveform is a main concern. The speed depends on the oscillation delay time and rise and fall times. In order to shorten the oscillation delay time, the laser diode is usually biased close to the threshold current. Fig. 10 shows a typical response waveform when a rectangular pulse current (rise/fall time is shorter than 0.2ns) is applied. The output power is 5mW and bias current $I_b = I_{th}$. Rise/fall time is typically 0.2ns.

Fig. 10 Pulse response waveform

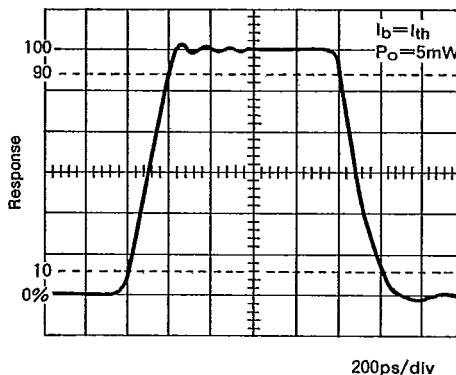

7 Monitoring output

The laser diodes emit beams from both of their mirror surfaces, front and rear surfaces (see the outline drawing). The rear beam can be used for monitoring power of the front beam since the power of the rear beam is proportional to the front one. In the ML9XX2 series the rear beam power is changed into photocurrents by monitor photodiodes. Fig. 11 shows typical light output vs. monitoring photocurrent characteristics. Above the threshold current, the monitored photocurrent increases linearly with the front light output. The monitoring output current is typically 0.5mA when the front light output is 5mW.

In the ML9912, monitor photodiode is not installed in the laser package. Monitoring output is emitted from the back of package. Monitoring output is typically 1mW when the front light output is 5mW.

Fig. 11 Light output vs. monitoring output current

