

The TNC Coaxial Connector Series with improved performance conforms to the interface standard of MIL-C-39012.

Design and Construction

The outer shell and coupling mechanism are available in stainless steel, nickel plated brass, gold plated beryllium copper, and aluminum. The choice of material is determined by application, durability, cost and weight. The center contact is made of gold plated beryllium copper. The dielectric is PTFE fluorocarbon.

Upper Operating Frequency

The upper operating frequency for the standard TNC series is 15.0 GHz. 18.0 GHz extended frequency range series is also available in this catalog. The 18.0 GHz series is a modified design which, while conforming to MIL-C-39012 interface standard, is also designed to be free of higher order mode resonance.

Table of Contents

TNC Mating Interface Dimensions	199
Specifications	200

Semi-Rigid Cable Type	201
.085 and .141 Diameter-Direct Solder Attachment	
.085 and .141 Diameter-Solder Clamp Attachment	
.250 and .325 Diameter-Clamp Attachment	
.085 and .141 Diameter-Solderless Compression Crimp Attachment	
.375 and .500 Diameter-Clamp Attachment	
Flexible Cable Type	206
Clamp Attachment	
Crimp Attachment	
Panel Mount Receptacles	209
Solder Pot Terminal	
Straight Terminal	
Strip Transmission Line	210
End Launch	
Surface Launch	
In-Series Adapters	211
Keyed Connectors	212
Semi-Rigid Cable Type	
Direct Solder Attachment	
Solder Clamp Attachment	
Flexible Cable Type	
Clamp Attachment	
Crimp Attachment	

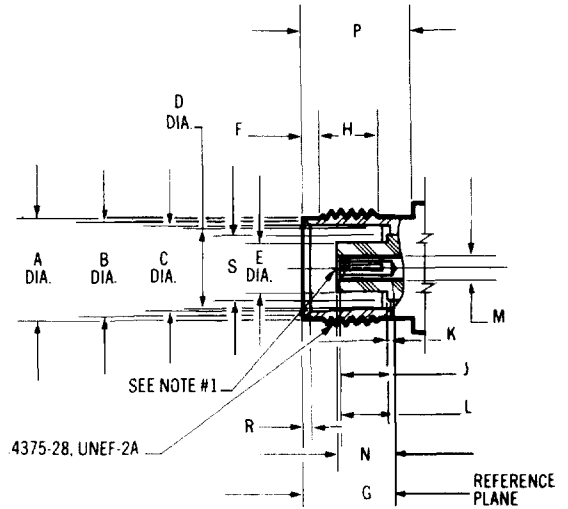
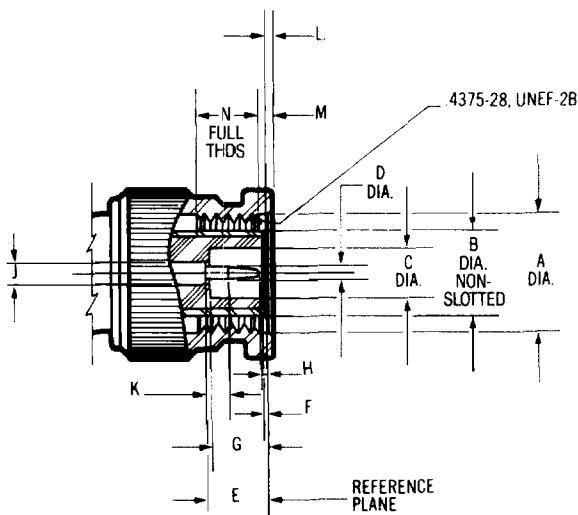

PLUG

Letter	Inches (Millimeters) ³	
	Minimum	Maximum
A	.440 (11.18)	-
B	-	.318 (8.08)
C	.190 (4.83)	-
D	.052 (1.32)	.054 (1.37)
E	.210 (5.33)	.230 (5.84)
F	.006 (0.15)	-
G	.208 (5.28)	.228 (5.79)
H	.003 (0.08)	.040 (1.02)
J	.081 (2.06)	.087 (2.21)
K	.078 (1.98)	-
L	-	.078 (1.98)
M	.063 (1.60)	-
N	.156 (3.96)	-
P	-	.025 (0.64)

JACK

Letter	Inches (Millimeters) ³	
	Minimum	Maximum
A	.378 (9.60)	.381 (9.68)
B	.346 (8.79)	.356 (9.04)
C	.327 (8.31)	.333 (8.46)
D	.319 (8.10)	.321 (8.15)
E	-	.186 (4.72)
F	.068 (1.73)	.088 (2.24)
G	.327 (8.30)	.335 (8.51)
H	.187 (4.75)	-
J	.186 (4.72)	.206 (5.23)
K	-	.006 (0.15)
L	.195 (4.95)	-
M	.081 (2.06)	.087 (2.21)
N	.188 (4.78)	.208 (5.28)
P	.414 (10.52)	-
R	.015 (0.38)	.030 (0.77)
S	-	.256 (6.50)

1. ID to meet VSWR and contact resistance when mated with .053 ± .001 (1.3462 ± .0254mm) dia. pin.
2. When fully engaged, the two reference planes must coincide with metal to metal contact.
3. Metric equivalents (to the nearest 0.01mm) are given for general information only.

Requirement	MIL-C-39012 Applicable Paragraph	Detail
General		
Material	3.3.3	Brass, half hard per QQ-B-626. Steel, corrosion resistant per ASTM-A-484 and ASTM-A-582, Type 303. Beryllium copper per ASTM-B-196. PTFE Fluorocarbon per ASTM-D-1457.
Finish	3.3.1	Center contacts shall be gold plated to a min. thickness of .0001 inch in accordance with MIL-G-45204, Type I, Grade C. All other metal parts shall be finished as to provide a connector which meets the corrosion requirements.
Design	3.4	The design shall be such that the outline shown in this catalog and the interface dimensions of MIL-STD-348A are met for 15 GHz design only.
Electrical		
Insulation Resistance	3.11	The insulation resistance shall not be less than 5,000 megohms.
Corona Level	3.22	The connector shall not exhibit breakdown when the voltage is 375 volts rms at 70,000 ft.
Dielectric Withstanding Voltage	3.17	The magnitude of the test voltage shall be 1500 volts rms at sea level.
RF High Potential	3.23	The withstanding voltage is 1,000 volts rms at 5 MHz. Leakage current is not applicable.
Contact Resistance	3.16	Refer to applicable military slash sheet or consult factory.
VSWR	3.14	Refer to applicable military slash sheet or consult factory. Frequency range dependent on cable used.
RF Leakage	3.26	Refer to applicable military slash sheet or consult factory.
Insertion Loss	3.27	Refer to applicable military slash sheet or consult factory. Frequency range dependent on cable used.
Mechanical		
Force to Engage	3.5.1	The torque required to engage and disengage shall not exceed 2 in.-lbs. The longitudinal force is not applicable.
Coupling Nut Retention	3.25	100 lbs. min. Applicable for plug connectors only.
Coupling Proof Torque	3.6	15 in.-lbs. min. Applicable for plug connectors only.
Cable Retention	3.24	Refer to applicable military slash sheet or consult factory.
Mating Characteristics	3.7	Applicable to jack connectors only. Reference MIL-STD-348A for dimensions; oversize test pin .055 min. dia., .125 deep; insertion force 2 lbs. max. with .054 min. dia. pin; withdrawal force 2 oz. min. with .052 max. dia. pin.
Connector Durability	3.15	The connector to be tested and its mating connector shall be subjected to 500 insertion and withdrawal cycles at 12 cycles per minute max. The connector shall show no evidence of mechanical failure and shall meet the mating characteristic requirements.
Recommended Mating Torque	—	12 to 15 in.-lbs.
Environmental		
Vibration	3.18	Specification MIL-STD-202, method 204, test condition B.
Shock	3.19	Specification MIL-STD-202, method 213, test condition I.
Thermal Shock	3.20	Refer to applicable military slash sheet or consult factory.
Corrosion (Salt Spray)	3.13	Specification MIL-STD-202, method 101, test condition B.
Moisture Resistance	3.21	Specification MIL-STD-202, method 106. No measurements at high humidity. Insulation resistance shall be at least 200 megohms within 5 minutes of removal from humidity.

TNC

For Semi-Rigid Cable

TNC series 50 ohm Connectors for semi-rigid cable are highly reliable, low VSWR connectors for use on .085-inch, .141-inch, .250-inch and .325-inch semi-rigid cables.

Each connector body and/or coupling nut is made of stainless steel for long life. The solder-on center contact is beryllium copper, gold plated and supported by a PTFE fluorocarbon dielectric.

These TNC Series Cable Connectors are designed to provide improved electrical performance when mated with TNC type connectors with interface dimensions per MIL-C-39012.

.085 and .141 Dia. • Direct Solder Attachment

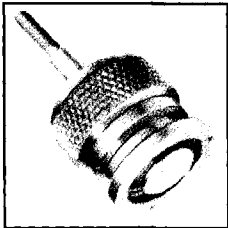

Straight Cable Plug

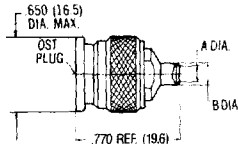

Cable	RG 402/U (.141)	RG 405/U (.085)	.141
Cable Dielectric	Solid PTFE	Solid PTFE	Microporous PTFE
Part Number	3101-7941-00	3101-7985-00	3101-7943-02
Dim. A	Inches (mm) .144 Min. (3.7)	Inches (mm) .089 Min. (2.3)	Inches (mm) .144 Min. (3.7)
Dim. B	.180 (4.6)	.120 (3.0)	.180 (4.6)

Finish: Housing is stainless steel, gold plated. Coupling nut is passivated stainless steel.
Refer to Appendix for Coaxial Cable Characteristics.
Refer to recommended assembly tools in Tool Section.

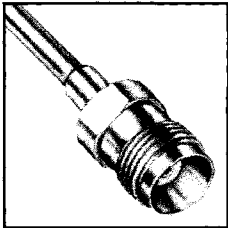

Straight Cable Jack

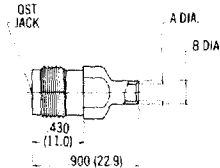

Cable	RG 402/U (.141)	RG 405/U (.085)	.141
Cable Dielectric	Solid PTFE	Solid PTFE	Microporous PTFE
Part Number	3102-7941-00	3102-7985-00	3102-7943-02
Dim. A	Inches (mm) .144 Min. (3.7)	Inches (mm) .089 Min. (2.3)	Inches (mm) .144 Min. (3.7)
Dim. B	.180 (4.6)	.120 (3.0)	.180 (4.6)

Finish: Housing soldered to the cable outer conductor is gold plated.
Refer to Appendix for Coaxial Cable Characteristics.
Refer to recommended assembly tools in Tool Section.

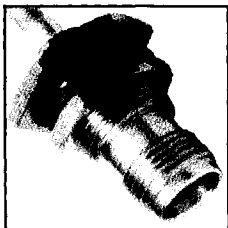

Bulkhead Feedthrough Cable Jack

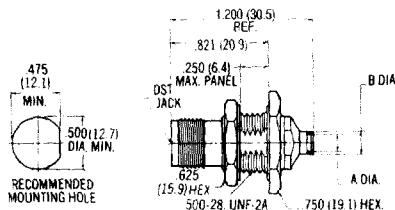

Cable	RG 402/U (.141)	RG 405/U (.085)
Cable Dielectric	Solid PTFE	Solid PTFE
Part Number	3104-7941-00	3104-7985-00
Dim. A	Inches (mm) .144 Min. (3.7)	Inches (mm) .089 Min. (2.3)
Dim. B	.180 (4.6)	.120 (3.0)

Finish: Housing and coupling nut are passivated stainless steel. The cable adapter section is gold plated for solder attachment.
Refer to Appendix for Coaxial Cable Characteristics.
Refer to recommended assembly tools in Tool Section.

TNC For Semi-Rigid Cable

.085 and .141 Dia. • Direct Solder Attachment

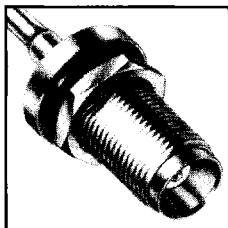

Bulkhead Feedthrough Cable Jack

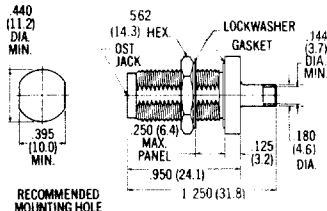

Cable	RG 402/U (.141)	.141
Cable Dielectric	Solid PTFE	Microporous PTFE
Part Number	3104-5068-00	3104-7943-00

Finish: Housing soldered to the cable outer conductor is gold plated. Refer to Appendix for Coaxial Cable Characteristics. Refer to recommended assembly tools in Tool Section.

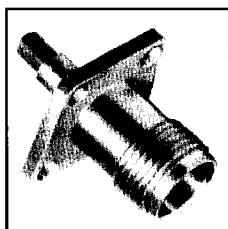

Flange Mount Cable Jack

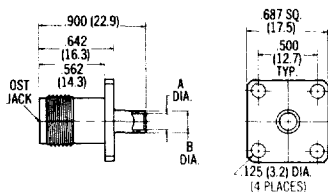

Cable	RG 402/U (.141)	RG 405/U (.085)
Cable Dielectric	Solid PTFE	Solid PTFE
Part Number	3106-7941-00	3106-7985-00
Dim. A	Inches (mm) .144 Min. (3.7)	Inches (mm) .089 Min. (2.3)
Dim. B	.180 (4.6)	.120 (3.0)

Finish: Housing soldered to the cable outer conductor is gold plated. .141 Microporous PTFE cable dielectric available. Consult factory. Refer to Appendix for Coaxial Cable Characteristics. Refer to recommended assembly tools in Tool Section.

The Solder Clamp Attachment is a solder type attachment to an inside bushing which will allow cable rotation and

locking in any angular position. This provides for simple cable attachment with packaging flexibility.

.085 and .141 Dia. • Solder Clamp Attachment

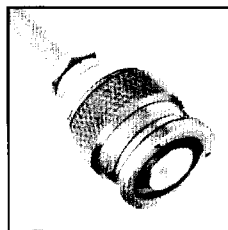

Straight Cable Plug

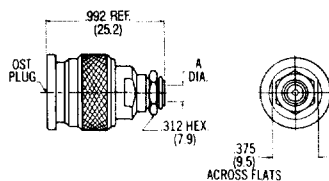

Cable	RG 402/U (.141)	RG 405/U (.085)
Cable Dielectric	Solid PTFE	Solid PTFE
Part Number	3101-7841-00	3101-7885-00
Dim. A	Inches (mm) .144 Min. (3.7)	Inches (mm) .089 Min. (2.3)

Finish: Housing and coupling nut are passivated stainless steel. The cable adapter section is gold plated for solder attachment. .141 Microporous PTFE cable dielectric available. Consult factory. Refer to Appendix for Coaxial Cable Characteristics. Refer to recommended assembly tools in Tool Section.

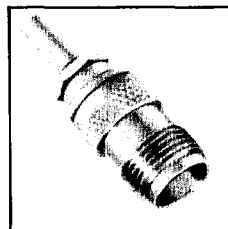

Straight Cable Jack

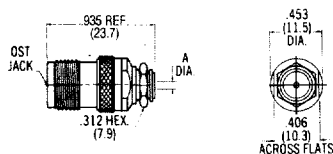

Cable	RG 402/U (.141)	RG 405/U (.085)
Cable Dielectric	Solid PTFE	Solid PTFE
Part Number	3102-7841-00	3102-7885-00
Dim. A	Inches (mm) .144 Min. (3.7)	Inches (mm) .089 Min. (2.3)

Finish: Housing and coupling nut are passivated stainless steel. The cable adapter section is gold plated for solder attachment. .141 Microporous PTFE cable dielectric available. Consult factory. Refer to Appendix for Coaxial Cable Characteristics. Refer to recommended assembly tools in Tool Section.

TNC For Semi-Rigid Cable

.085 and .141 Dia. • Solder Clamp Attachment

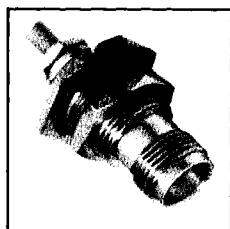

Bulkhead Feedthrough Cable Jack

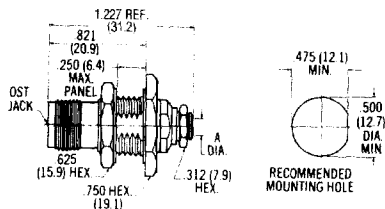

Cable	RG 402/U (.141)	RG 405/U (.085)
Cable Dielectric	Solid PTFE	Solid PTFE
Part Number	3104-7841-00	3104-7885-00
Dim. A	Inches (mm) .142 Min. (3.6)	Inches (mm) .0875 Min. (2.2)

Finish: Housing and coupling nut are passivated stainless steel. The cable adapter section is gold plated for solder attachment.
 .141 Microporous PTFE cable dielectric available. Consult factory.
 Refer to Appendix for Coaxial Cable Characteristics.
 Refer to recommended assembly tools in Tool Section.

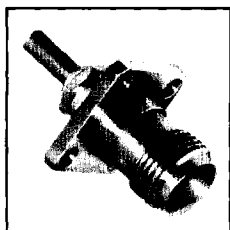

Flange Mount Cable Jack

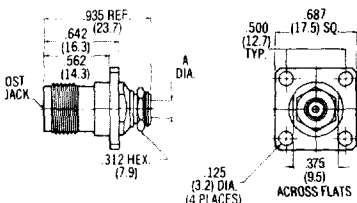

Cable	RG 402/U (.141)	RG 405/U (.085)
Cable Dielectric	Solid PTFE	Solid PTFE
Part Number	3106-7841-00	3106-7885-00
Dim. A	Inches (mm) .142 Min. (3.6)	Inches (mm) .0875 Min. (2.2)

Finish: Housing and coupling nut are passivated stainless steel. The cable adapter section is gold plated for solder attachment.
 .141 Microporous PTFE cable dielectric available. Consult factory.
 Refer to Appendix for Coaxial Cable Characteristics.
 Refer to recommended assembly tools in Tool Section.

The Compression Clamp Attachment provides a quick and easy solderless cable outer jacket attachment utilizing

standard laboratory hand tools. This provides simple cable attachment for laboratory and prototype application.

.250 and .325 Dia. • Clamp Attachment

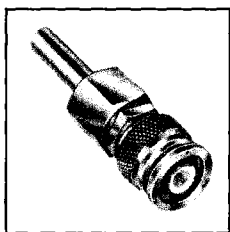

Straight Cable Plug

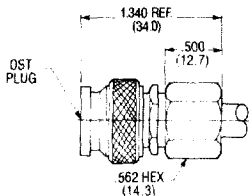

Cable	RG 401/U (.250)	.250	.325
Cable Dielectric	Solid PTFE	Microporous PTFE & Foam	Solid PTFE
Compression Clamp Attachment			
Part Number	3101-7750-00	3101-7752-02	3101-7725-02

Finish: Passivated stainless steel
 Press clamp attachment available. Consult factory.
 Refer to Appendix for Coaxial Cable Characteristics.
 Refer to recommended assembly tools in Tool Section.

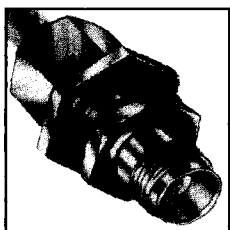

Bulkhead Feedthrough Jack

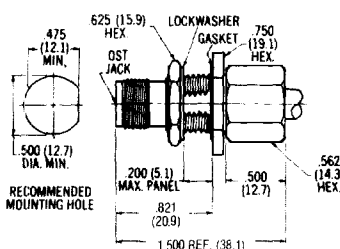

Cable	RG 401/U (.250)	.250	.325
Cable Dielectric	Solid PTFE	Microporous PTFE & Foam	Solid PTFE
Compression Clamp Attachment			
Part Number	3104-7750-00	3104-7752-02	3104-7725-02

Finish: Passivated stainless steel
 Press clamp attachment available. Consult factory.
 Refer to Appendix for Coaxial Cable Characteristics.
 Refer to recommended assembly tools in Tool Section.

TNC Solderless Compression Crimp

TNC 50 ohm Solderless Compression Crimp Connectors are available for use on RG 402/U (.141 dia.) and RG 405/U (.085 dia.) semi-rigid cables. These completely assembled units feature captured center contacts, durable

stainless steel housings and coupling nuts, and M/A-COM'S Solderless Compression Crimp Cable Attachment. The center contact is beryllium copper, gold plated and is supported by a PTFE fluorocarbon dielectric.

.085 and .141 Solderless Cable Attachment

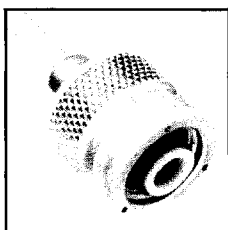

Straight Cable Plug

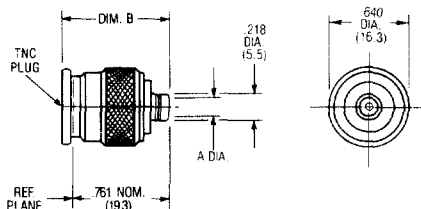

Cable	RG 402/U (.141)	RG 405/U (.085)
Part Number	3101-7641-02	3101-7685-02
Dim. A	Inches (mm) .143 (3.6)	Inches (mm) .088 Min. (2.2)
Dim. B	Before Crimping	.923 Max. (23.4)
	After Crimping	.780 Max. (19.8)

Finish: Passivated stainless steel. For gold plate, change the Part Number suffix from -02 to -00. Coupling nut is passivated in all cases. All outline drawings show after crimping configurations. Refer to Appendix for Coaxial Cable Characteristics. Refer to recommended assembly tools in Tool Section.



Bulkhead Feedthrough Cable Jack

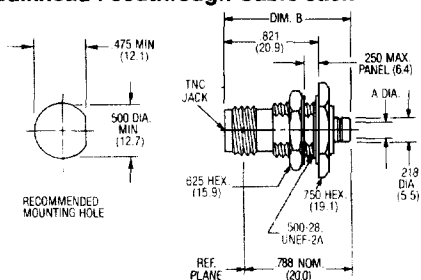

Cable	RG 402/U (.141)	RG 405/U (.085)
Part Number	3104-7641-02	3104-7685-02
Dim. A	Inches (mm) .143 (3.6)	Inches (mm) .088 Min. (2.2)
Dim. B	Before Crimping	1.269 Max. (32.2)
	After Crimping	1.125 Max. (28.6)

Finish: Passivated stainless steel. For gold plate, change the Part Number suffix from -02 to -00. All outline drawings show after crimping configurations. Refer to Appendix for Coaxial Cable Characteristics. Refer to recommended assembly tools in Tool Section.

TNC

For High Power • Low Loss Cable

The TNC connectors have been designed for use with high power low loss semi-rigid coaxial cable of .375 and .500-inch diameters. Each connector body and/or coupling nut is made of aluminum for light weight. The

bodies have an iridited finish while the coupling and clamp nuts are anodized. The solder-on center contact is beryllium copper, gold plated and supported by a PTFE fluoroarbon dielectric.

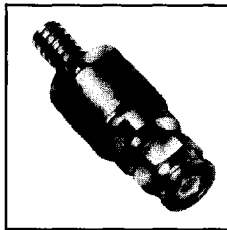

Straight Cable Plug

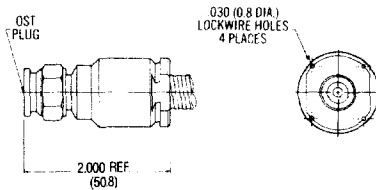

Cable	.375	.500
Cable Dielectric	Microporous PTFE	Microporous PTFE
Compression Clamp Attachment		
Part Number	3101-7575-00	3101-7500-00

Finish: Aluminum. Housing is iridited. Coupling and clamp nuts are anodized.

Press clamp attachment available.
Refer to Appendix for Coaxial Cable Characteristics.
Refer to recommended assembly tools in Tool Section.

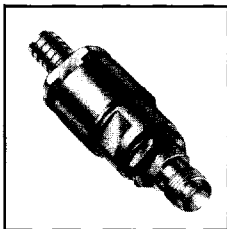

Bulkhead Feedthrough Cable Jack

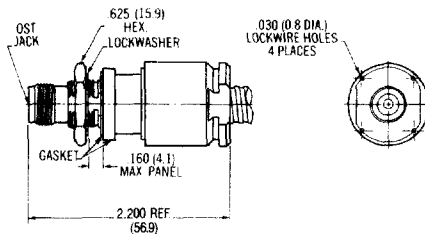

Cable	.375	.500
Cable Dielectric	Microporous PTFE	Microporous PTFE
Compression Clamp Attachment		
Part Number	3104-7575-00	3104-7500-00

Finish: Aluminum. Housing is iridited. Coupling and clamp nuts are anodized.

Press clamp attachment available.
Refer to Appendix for Coaxial Cable Characteristics.
Refer to recommended assembly tools in Tool Section.

M/A-COM, Inc.

205

North America: Tel. (800) 366-2266
Fax (800) 618-8883

Asia/Pacific: Tel. +85 2 2111 8088
Fax +85 2 2111 8087

Europe: Tel. +44 (1344) 869 595
Fax +44 (1344) 300 020

TNC

For Flexible Cable

M/A-COM's TNC series connectors feature constant 50 ohm impedance with low VSWR values. These connectors are ideally suited for terminating most popular flexible cables. Clamp attachment provides a quick and easy

solderless method of attachment for the outer conductor using standard connector assembly tools. The solder-on center contact is beryllium copper, gold plated and supported by a PTFE fluorocarbon dielectric.

Flexible Cable • Clamp Attachment

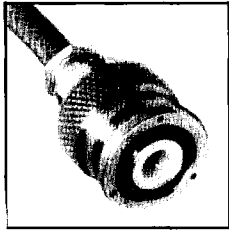

Straight Cable Plug

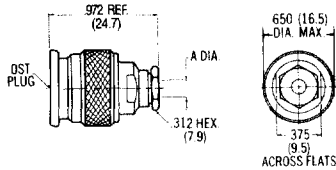

Cable	RG 55/U, 58, 141, 142, 223, 303	RG 174/U, 179, 187, 188, 316
Captured Center Contact		
Part Number	3101-7341-10	3101-7388-10
Dim. A	Inches (mm) .220 (5.6)	Inches (mm) .116 (2.9)

Finish: Nickel plated brass.
Refer to Appendix for Coaxial Cable Characteristics.
Refer to recommended assembly tools in Tool Section.

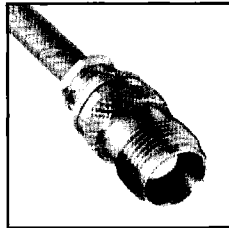

Straight Cable Jack

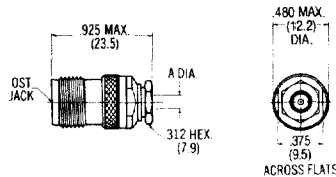

Cable	RG 55/U, 58, 141, 142, 223, 303	RG 174/U, 179, 187, 188, 316
Captured Center Contact		
Part Number	3102-7341-10	3102-7388-10
Dim. A	Inches (mm) .220 (5.6)	Inches (mm) .116 (2.9)

Finish: Nickel plated brass.
Refer to Appendix for Coaxial Cable Characteristics.
Refer to recommended assembly tools in Tool Section.

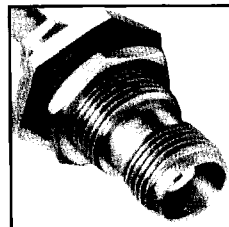

Bulkhead Feedthrough Cable Jack

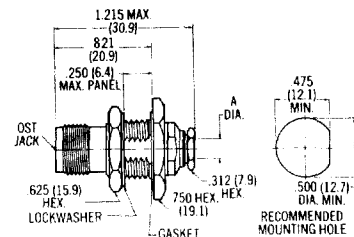

Cable	RG 55/U, 58, 141, 142, 223, 303	RG 174/U, 179, 187, 188, 316
Captured Center Contact		
Part Number	3104-7341-10	3104-7388-10
Dim. A	Inches (mm) .220 (5.6)	Inches (mm) .116 (2.9)

Finish: Nickel plated brass.
Refer to Appendix for Coaxial Cable Characteristics.
Refer to recommended assembly tools in Tool Section.

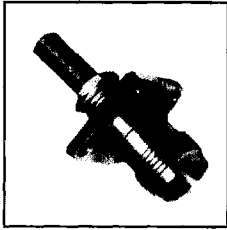

Flange Mount Cable Jack

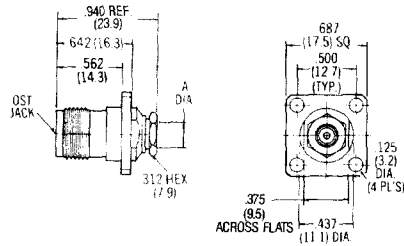

Cable	RG 55/U, 58, 141, 142, 223, 303	RG 174/U, 179, 187, 188, 316
Captured Center Contact		
Part Number	3106-7341-10	3106-7388-10
Dim. A	Inches (mm) .220 (5.6)	Inches (mm) .116 (2.9)

Finish: Nickel plated brass.
Refer to Appendix for Coaxial Cable Characteristics.
Refer to recommended assembly tools in Tool Section.

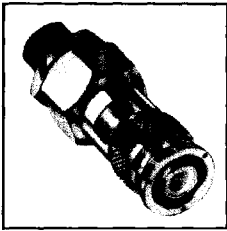

Straight Cable Plug

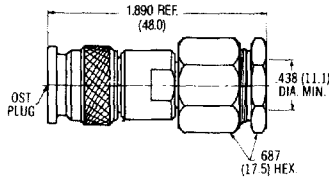

Cable	RG 214/U, 225, 393
Part Number	3101-7214-10

Finish: Nickel plated brass.
Refer to Appendix for Coaxial Cable Characteristics.
Refer to recommended assembly tools in Tool Section.

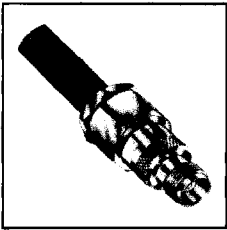

Straight Cable Jack

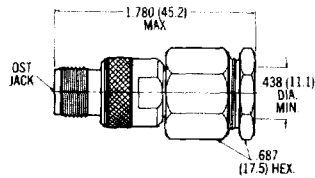

Cable	RG 214/U, 225, 393
Part Number	3102-7214-10

Finish: Nickel plated brass.
Refer to Appendix for Coaxial Cable Characteristics.
Refer to recommended assembly tools in Tool Section.

Flexible Cable • Crimp Attachment

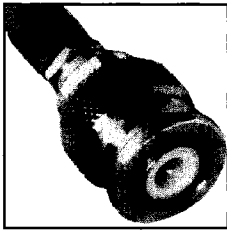

Straight Cable Plug

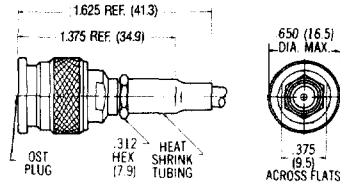

Cable	RG 58/U, 141, 303	RG 55/U, 142, 223, 400	RG 174/U, 179 187, 188 316
Captured Center Contact			
Part Number	3131-7358-10	3131-7341-10	3131-7388-10

Finish: Nickel plated brass.
Refer to Appendix for Coaxial Cable Characteristics.
Refer to recommended assembly tools in Tool Section.

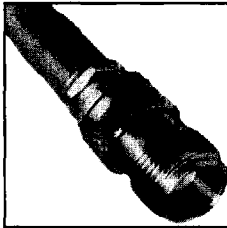

Straight Cable Jack

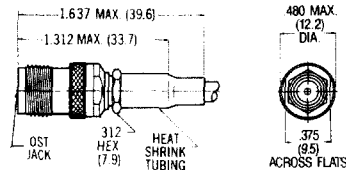

Cable	RG 58/U, 141, 303	RG 55/U, 142, 223, 400	RG 174/U, 179 187, 188 316
Captured Center Contact			
Part Number	3132-7358-10	3132-7341-10	3132-7388-10

Finish: Nickel plated brass.
Refer to Appendix for Coaxial Cable Characteristics.
Refer to recommended assembly tools in Tool Section.

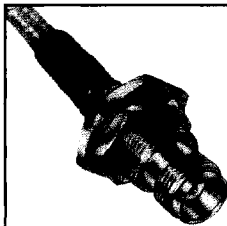

Bulkhead Feedthrough Cable Jack

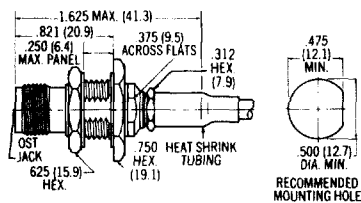

Cable	RG 58/U, 141, 303	RG 55/U, 142, 223, 400	RG 174/U, 179 187, 188 316
Captured Center Contact			
Part Number	3134-7358-10	3134-7341-10	3134-7388-10

Finish: Nickel plated brass.
Refer to Appendix for Coaxial Cable Characteristics.
Refer to recommended assembly tools in Tool Section.

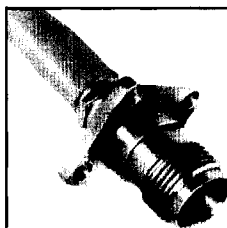

Flange Mount Cable Jack

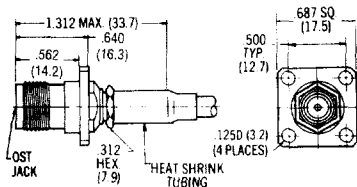

Cable	RG 58/U, 141, 303	RG 55/U, 142, 223, 400	RG 174/U, 179 187, 188 316
Captured Center Contact			
Part Number	3136-7358-10	3136-7341-10	3136-7388-10

Finish: Nickel plated brass.
Refer to Appendix for Coaxial Cable Characteristics.
Refer to recommended assembly tools in Tool Section.

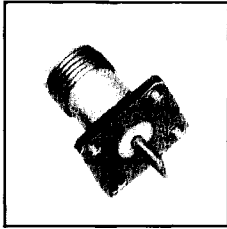

Flange Mount Jack Receptacle

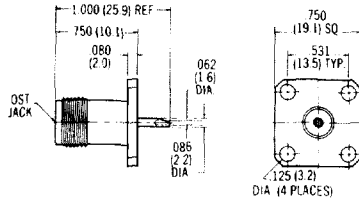

Captured Center Contact Solder Pot Terminal	
Part Number	3152-0000-10

Finish: Nickel plated brass.

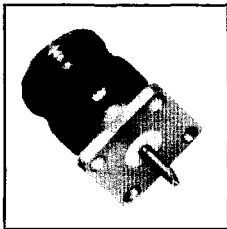

Flange Mount Plug Receptacle

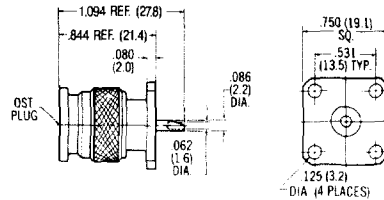

Captured Center Contact Solder Terminal	
Part Number	3151-0000-10

Finish: Nickel plated brass.

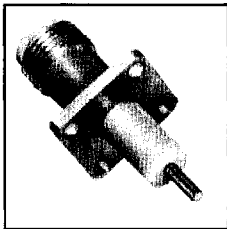

Flange Mount Jack Receptacle

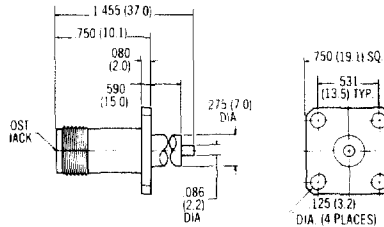

Non-Captured Center Contact Straight Terminal	
Part Number	3152-1200-10
Captured Center Contact Straight Terminal	
Part Number	3152-1201-10

Finish: Nickel plated brass.



Flange Mount Plug Receptacle

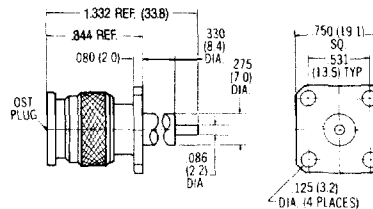

Non-Captured Center Contact Straight Terminal	
Part Number	3151-1200-10
Captured Center Contact Straight Terminal	
Part Number	3151-1201-10

Finish: Nickel plated brass.

Panel Mount Receptacle

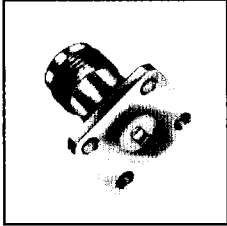

Flange Mount Jack Receptacle

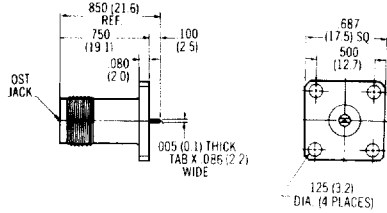

Captured Center Contact Tab Terminal	
Part Number	3152-1628-10

Finish: Nickel plated brass.

End • Surface Launch For Use On Stripline Circuits

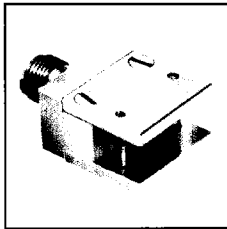

End Launch Jack

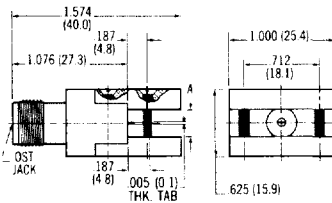

Captured Center Contact Tab Terminal						
Stripline Size	1/8		1/4		3/8	
Part Number	3170-1402-10		3170-1403-10		3170-1404-10	
Dim. A	Inches	(mm)	Inches	(mm)	Inches	(mm)
	.125	(3.2)	.250	(6.4)	.375	(9.5)

Finish: Nickel plated brass.
End Launch plug available.

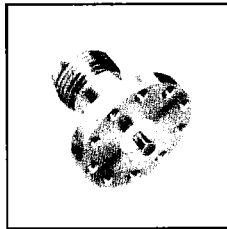

Surface Launch Jack

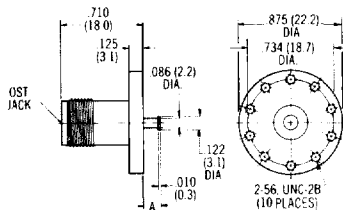

Non-Captured Center Contact Turret Terminal						
Stripline Size	1/8		1/4		3/8	
Part Number	3166-1442-10		3166-1443-10		3166-1444-10	
Dim. A	Inches	(mm)	Inches	(mm)	Inches	(mm)
	.063	(1.6)	.125	(3.2)	.187	(4.8)

Finish: Nickel plated brass.

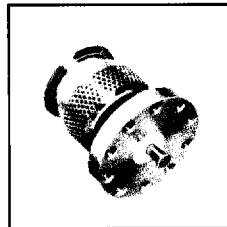

Surface Launch Plug

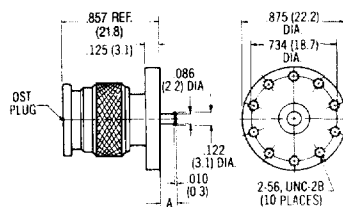

Non-Captured Center Contact Turret Terminal						
Stripline Size	1/8		1/4		3/8	
Part Number	3167-1442-10		3167-1443-10		3167-1444-10	
Dim. A	Inches	(mm)	Inches	(mm)	Inches	(mm)
	.063	(1.6)	.125	(3.2)	.187	(4.8)

Finish: Nickel plated brass.

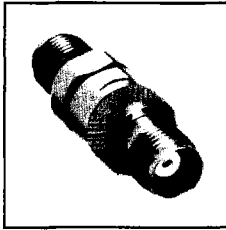

Jack to Jack Adapter

Part Number	3180-0000-00
--------------------	---------------------

Finish: Passivated stainless steel.

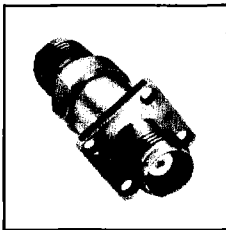
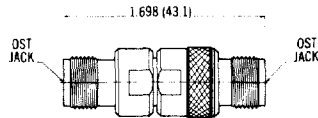

Jack to Jack Adapter Flange Mount

Part Number	3180-2312-00
--------------------	---------------------

Finish: Passivated stainless steel.

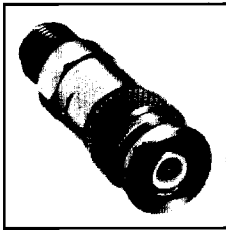
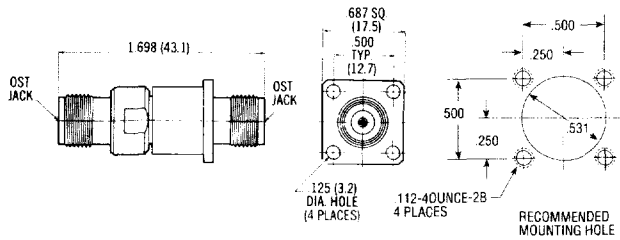

Jack to Plug Adapter

Part Number	3182-0000-00
--------------------	---------------------

Finish: Passivated stainless steel.

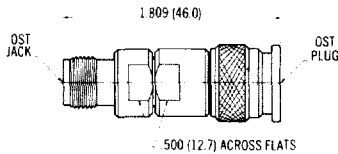

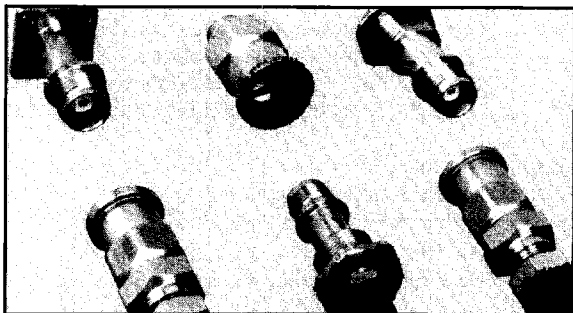

For applications where cross mating of connectors can cause catastrophic failure, M/A-COM Interconnect Division has designed a fool-proof series of "keyed" connector products. A complete line of keyed TNC designs are available.

In principle, each interconnect is defined as a mated pair designed to mate only with each other. Typically, twenty-four different keying schemes are available for each part number. Keying is integral to the connector housing and coupling nut.

The interface of the connector is still fully compatible with MIL-C-39012.

The mated pair in Figure 1 illustrates the concept behind keying arrangements. Using machined flats, grooves and posts in both the coupling nut and housing permits twenty-four different keying arrangements. Examples of how each mated pair is specified for both the plug and jack are shown in Figures 2 and 3.

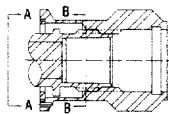

Figure 1

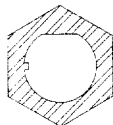
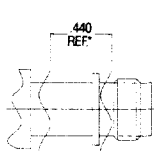

Figure 2



Figure 3



Jack

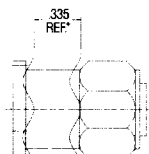

Plug

*In order not to interfere with the standard MIL-C-39012 interface, a fixed additional length must be incorporated into the housing and coupling of the connector chosen.

Available Key Combinations					
No.	Jack Angle	Mating Plug Angle	No.	Jack Angle	Mating Plug Angle
1	42°	318°	13	186°	174°
2	54°	306°	14	198°	162°
3	66°	294°	15	210°	150°
4	78°	282°	16	222°	138°
5	90°	270°	17	234°	126°
6	102°	258°	18	246°	114°
7	114°	246°	19	258°	102°
8	126°	234°	20	270°	90°
9	138°	222°	21	282°	78°
10	150°	210°	22	294°	66°
11	162°	198°	23	306°	54°
12	174°	186°	24	318°	42°

Designs are available for any of the TNC family of connectors. Due to the number of combinations possible, consult the factory for specific part numbers and design

Plugs

Part No.	Description
3101-XXXX	Straight Cable Direct Solder
3101-XXXX	Straight Cable Solder Clamp
3101-XXXX	Flexible Cable Clamp
3131-XXXX	Flexible Cable Crimp
3151-XXXX	Flange Mount

assistance. Standard designs are available for the following series of connectors. You should refer to other sections of this catalog for detailed characteristics of each connector series.

Jacks

Part No.	Description
3104-XXXX	Bulkhead Cable Direct Solder
3104-XXXX	Bulkhead Cable Solder Clamp
3106-XXXX	Flange Mount Solder Clamp
3104-XXXX	Bulkhead Flexible Cable Clamp
3134-XXXX	Bulkhead Flexible Cable Crimp
3136-XXXX	Flange Mount Flexible Cable Crimp
3152-XXXX	Flange Mount