

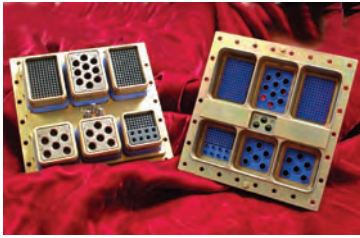

MIL-DTL-83527 Series Connectors

Part Number Assignment and Backshells



Sabritec's MIL-DTL-83527 Rack and Panel style connectors meet or exceed the applicable requirements of the military specification and come in a wide variety of insert arrangements and shell sizes. Contact patterns include mixed Signal, Power, Coax, Triax, Fiber Optic (ARINC 801 and Expanded Beam Contacts) Twinax and Quadrax contacts for standard or custom insert arrangements. They can also incorporate EMI filtering and transient EMP protection to help maintain signal integrity.

Sabritec's Twinax and Quadrax contacts offer balanced and matched impedance performance for a wide variety of transmission systems and cable characteristics. Our contacts are designed to ensure optimum signal integrity even at the highest data rates.

Contacts are offered with crimp or solder termination with anti-rotational keyed insert assemblies for High-Speed Fibre Channel or Ethernet type applications. These connectors are designed for extreme environmental concerns including shock, vibration and humidity.

Features:

- Isolated cavities available for tempest applications
- EMI/RFI environmentally sealed backshells
- Single or Multiport exit termination points with standard MIL-DTL-38999 backshells.

Backshells

Sabritec's rugged EMI/RFI environmental backshells for MIL-DTL-83527 and ARINC 600 connectors offer many innovative features including accessory threads, optional cable entry locations as well as single or multi-cavity ports.

Features:

- EMI/RFI Environmentally sealed backshells
- Moisture, splash and dust proof
- Resilient gasket sealing from the rear of the connector shell to the backshell junction

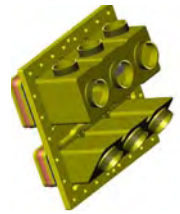

MIL-DTL-83527 Connector Description Code

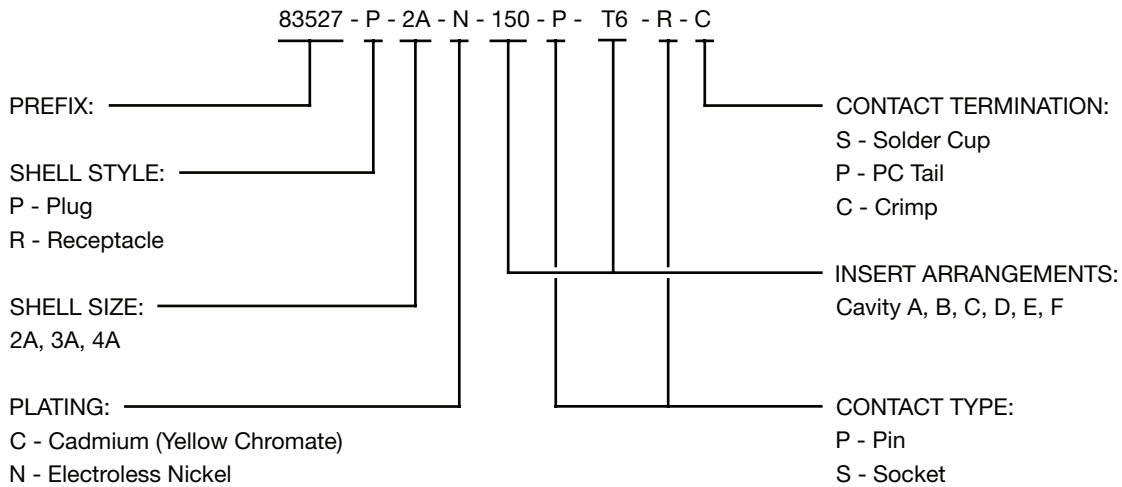

Sample Backshells

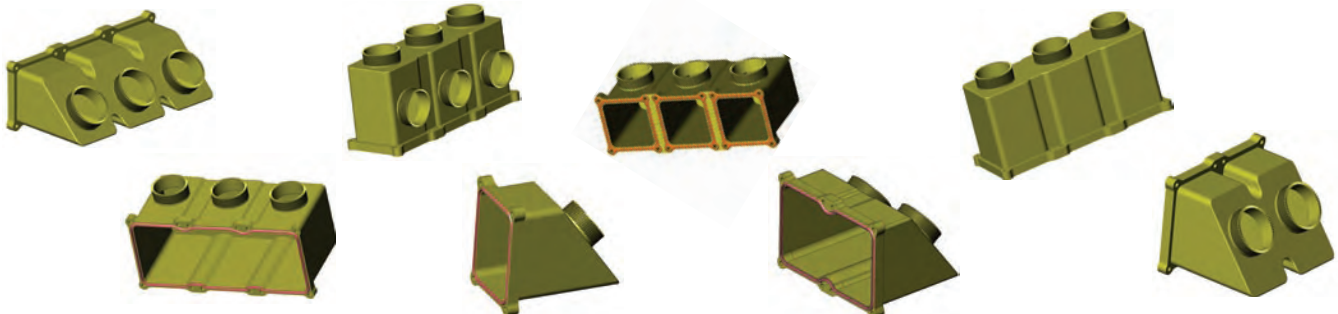



MIL-DTL-83527 Connectors

Shell Size 4A Plug and Receptacle and Insert Arrangements

MIL-DTL-83527 Shell Size 4A Plug

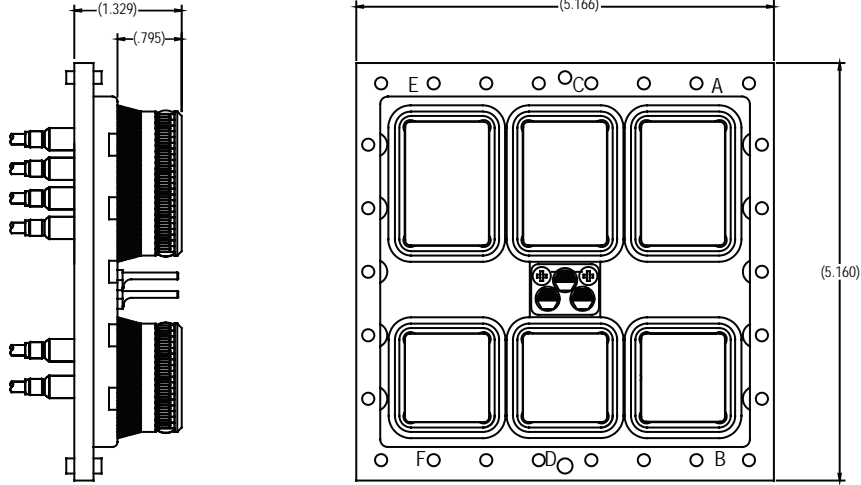

MIL-DTL-83527 Shell Size 4A Receptacle

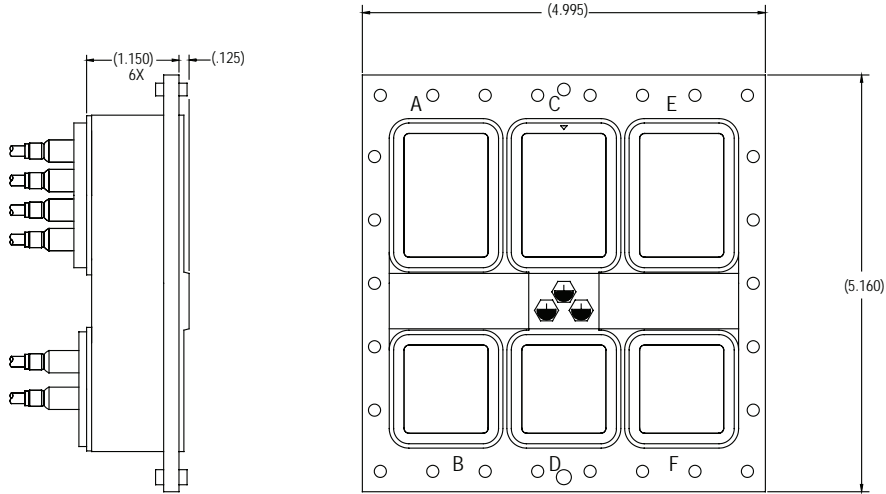

MIL-DTL-83527 Insert Arrangements

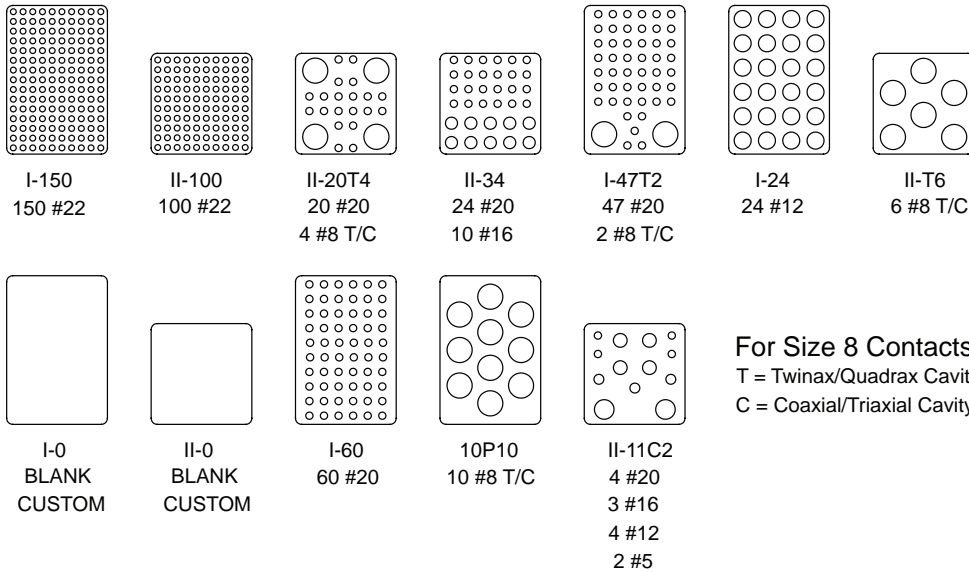

Sabritec provides specialty, enhanced performance connectors and cable assemblies and as such does not currently offer circular, rack and panel, or D-subminiature connectors that are listed on military standard Qualified Products Lists (QPL) per applicable detail specification sheets. Sabritec's connectors are fully interchangeable with applicable QPL products and meet the applicable requirements of all military standards listed in this catalog.

Size 8 Quadrax & Twinax 100 & 150 Ohm Contacts

Size 8 Twinax Pin Contact 100 and 150 Ohm

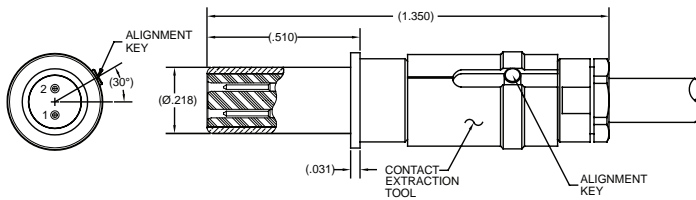

Part Number	Ohms	Cable Type	Cable
019634-0005	150	Differential Twinax	540-1099-000
019634-0006	150	Differential Twinax	540-1114-000
019634-0007	100	Differential Twinax	540-1086-000
019634-0008	100	Differential Twinax	540-1153-000
019634-0009	100	Flexible Twinax	540-1161-000

Size 8 Twinax Socket Contact 100 and 150 Ohm

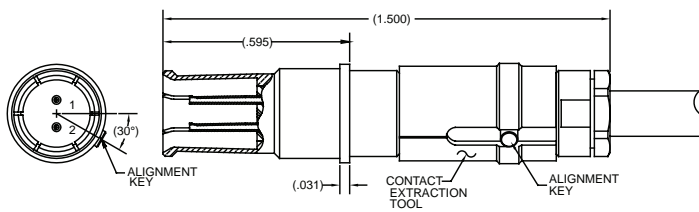

Part Number	Ohms	Cable Type	Cable
019534-0005	150	Differential Twinax	540-1099-000
019534-0006	150	Differential Twinax	540-1114-000
019534-0007	100	Differential Twinax	540-1086-000
019534-0008	100	Differential Twinax	540-1153-000
019534-0009	100	Flexible Twinax	540-1161-000

Size 8 Quadrax Pin Contact 100 Ohm

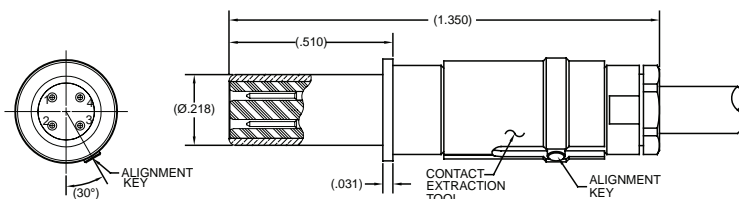

Part Number	Cable Type	Cable
019635-0000	Differential Quad	540-1183-000

Size 8 Quadrax Socket Contact 100 Ohm

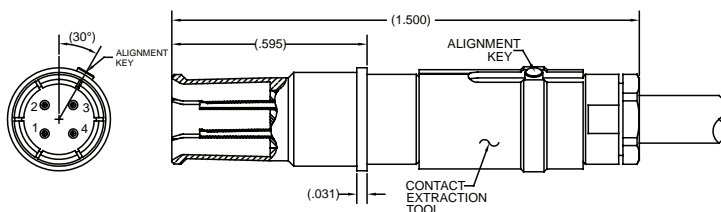

Part Number	Cable Type	Cable
019535-0000	Differential Quad	540-1183-000