

SINGLE ISOLATION AMPLIFIER

■ GENERAL DESCRIPTION

NJM2505A is the single isolation amplifier developed by the video signal. It can remove the noise of a signal with isolation amplifier and carries in the small package (MTP5), it is suitable for the interface of the video signal of a car AV system.

■ FEATURES

- Operating Voltage 4.5 to 9.0V
- Input: Sync-tip Clamp
- Common Mode Noise Rejection Ratio -55dBtyp.
- Voltage Gain 0dBtyp.
- Frequency Characteristics 0dBtyp.at 10MHz
- Bipolar Technology
- Package MTP5

■ PIN CONFIGURATION

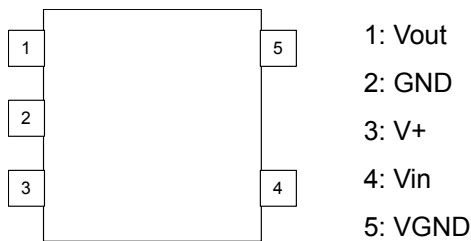

■ PACKAGE OUTLINE



NJM2505AF

■ BLOCK DIAGRAM

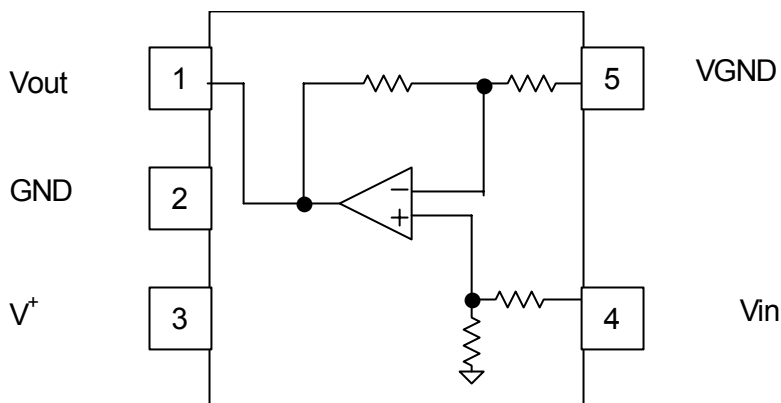

NJM2505A

■ ABSOLUTE MAXIMUM RATINGS(Ta=25°C)

PARAMETER	SYMBOL	RATINGS	UNIT
Supply Voltage	V ⁺	15.0	V
Power Dissipation	P _D	200	MW
Operating Temperature Range	Topr	-40 to +85	°C
Storage Temperature Range	Tstg	-40 to +125	°C

■ RECOMMENDED OPERATING CONDITION(Ta=25°C)

PARAMETER	SYMBOL	TEST CONDITION	MIN.	TYP.	MAX.	UNIT
Operating Voltage Range	Vopr		4.5	-	9.0	V

■ ELECTRICAL CHARACTERISTICS(V⁺ =5.0V, Ta=25°C)

PARAMETR	SYMBOL	TEST CONDITION	MIN.	TYP.	MAX.	UNIT
Supply Current	I _{CC}	No Signal	-	3.0	6.0	mA
Maximum Output Voltage Level	Vom	Vin=100kHz, Sin-Signal, THD=1%,	2.0	2.2	-	Vp-p
Voltage Gain	Gv	Vin=100kHz, 1.0Vp-p, Sin-Signal	-1.0	0	1.0	dB
Frequency Characteristics	Gf	Vin=10MHz / 1MHz , 1.0VppSin-Signal	-1.0	0	1.0	dB
Common Mode Noise Rejection Ratio	CMR	Vin=20KHz, Vin=1Vpp	-	-55	-	dB
Differential Gain	DG	Vin=1.0Vp-p, 10step Video Signal	-	0.3	-	%
Differential Phase	DP	Vin=1.0Vp-p, 10step Video Signal	-	0.4	-	deg

■ TEST CIRCUIT

When CMR is measured, VGND is connected with VIN.

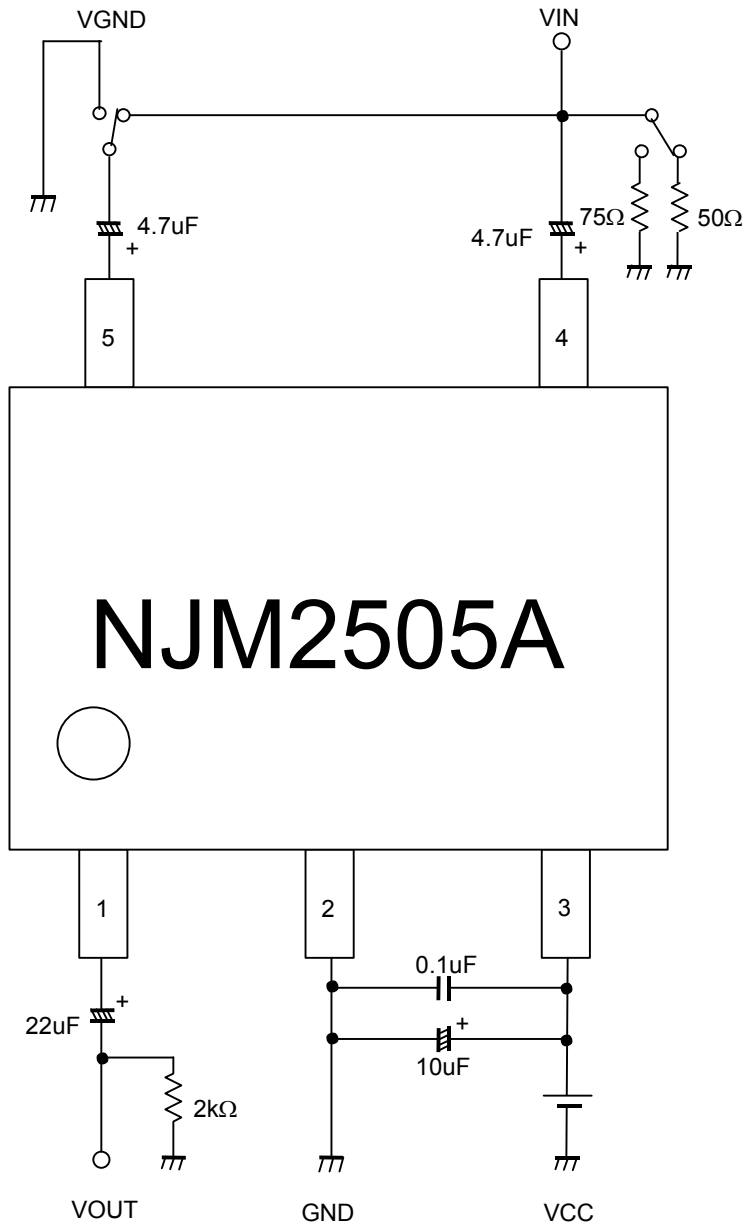

NJM2505A

■ APPLICATION CIRCUIT

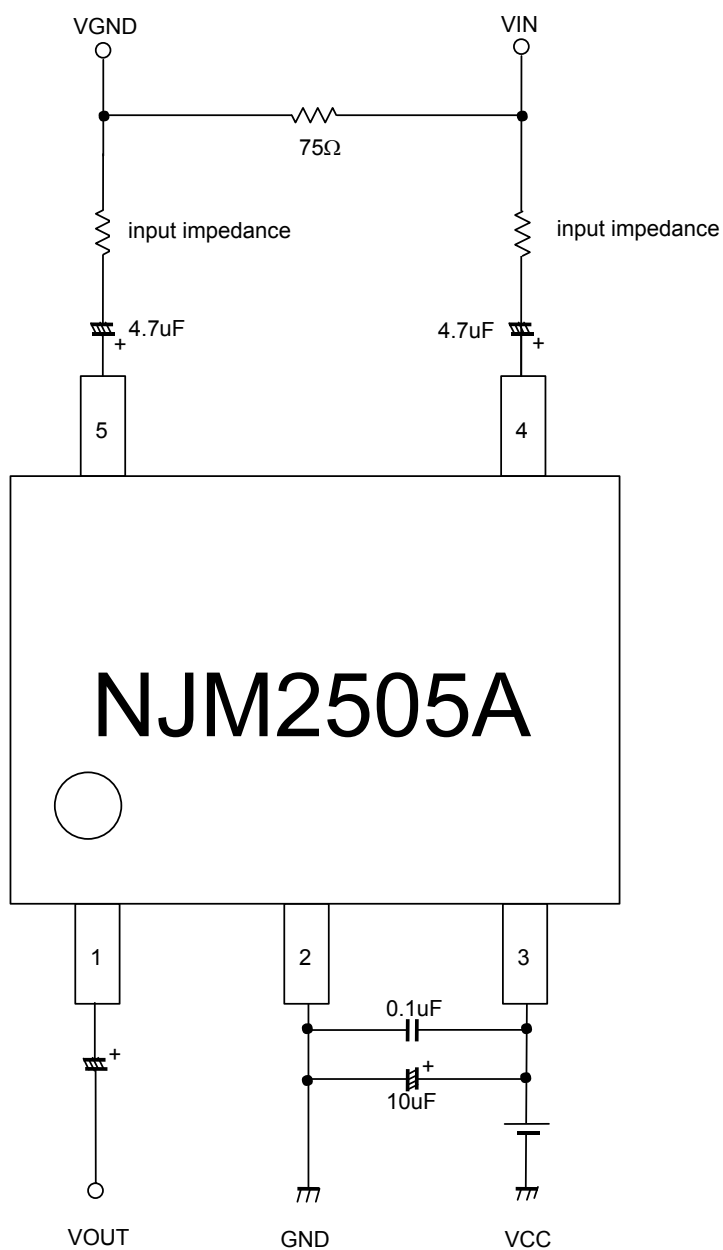

* NJM2505A don't built-in 75Ω driver circuit. This IC's load capability is than 2kΩ.
Please make adequate evaluation.

APPLICATION

1: Please connect input surge resistance to 4pin(Vin) and 5pin(VGND). Please refer to Fig. 1. If resistance is enlarged, a waveform may deteriorate.

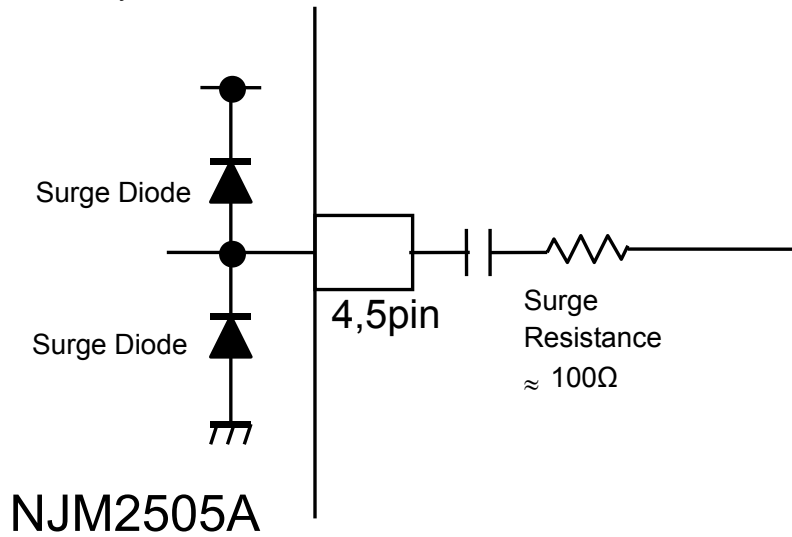

Fig1: External connection

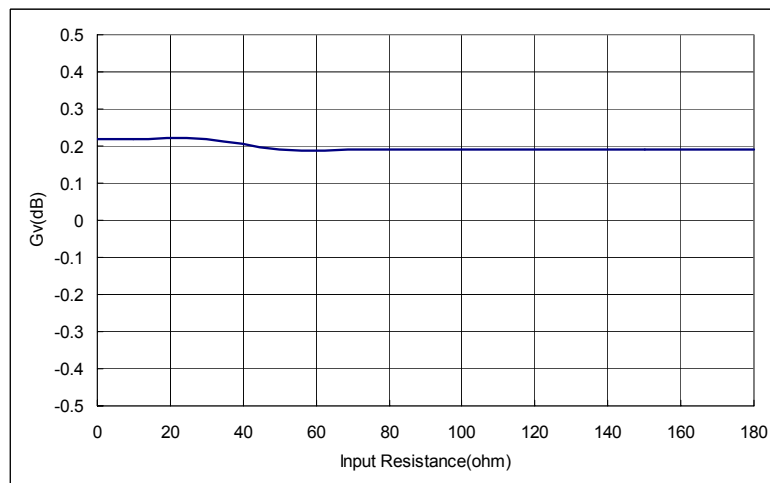

Fig2: Input resistance vs. Voltage gain

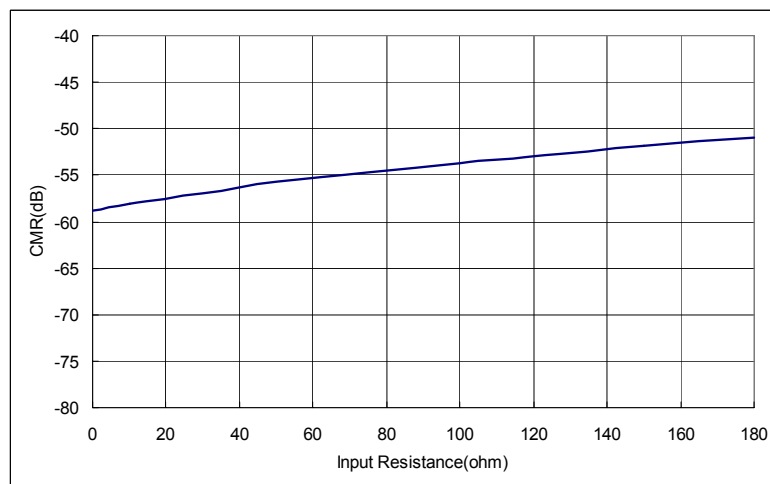

Fig3: Input resistance vs. Common mode rejection ratio

NJM2505A

2: Please connect a diode in a VGND at large common mode noise may be inputted into a Vin(4pin) and VGND(5pin). Thereby, large common noise is restricted(refer to Fig.4).Current flows to a diode. Be careful of current capacity.

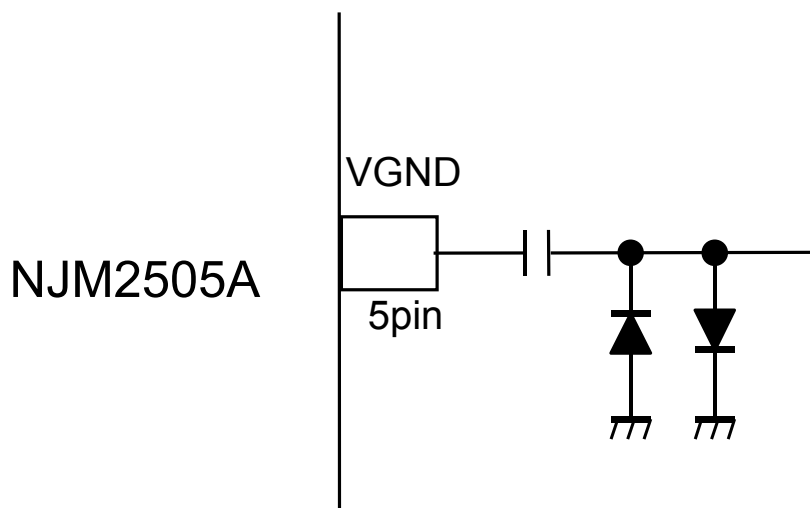

Fig4: External connection

■ EQUIVALENT CIRCUIT

Pin.No	Symbol	Inside Equivalent Circuit	Voitage
1	Vout		0.92V
2	GND	-	-
3	V ⁺	-	-
4	Vin		1.67V
5	VGND		1.67V

NJM2505A

■ TYPICAL CHARACTERISTICS

Voltage gain vs. Frequency
($V_{in}=100\text{kHz}$, 1.0Vp-p , $T_a=25^\circ\text{C}$)

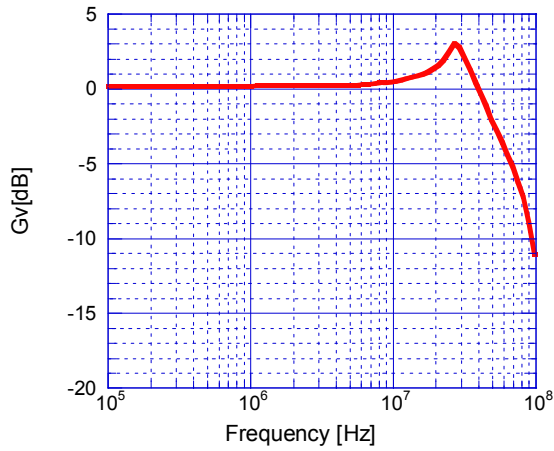

Common mode rejection ratio vs. Frequency
($V_{in}=1.0\text{Vp-p}$, $T_a=25^\circ\text{C}$)

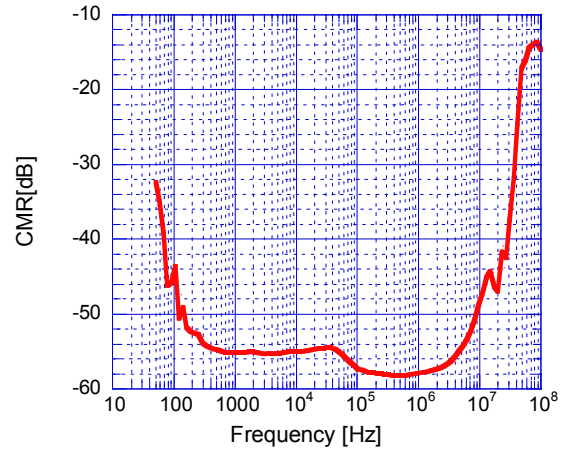

Supply current vs. Supply voltage
($T_a=25^\circ\text{C}$)

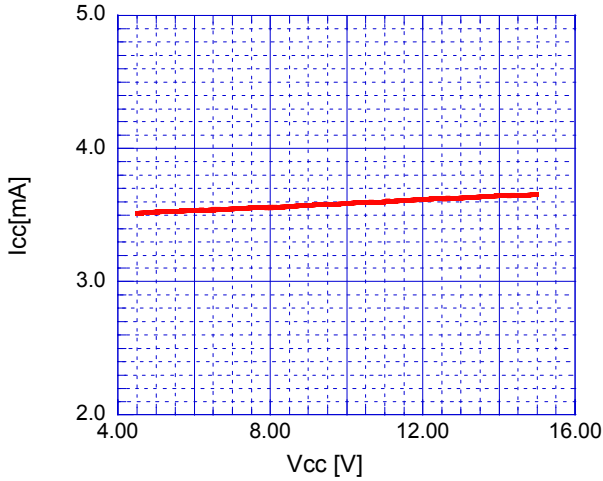

Maximum output voltage vs. Supply voltage
($V_{in}=100\text{kHz}$, $T_a=25^\circ\text{C}$)

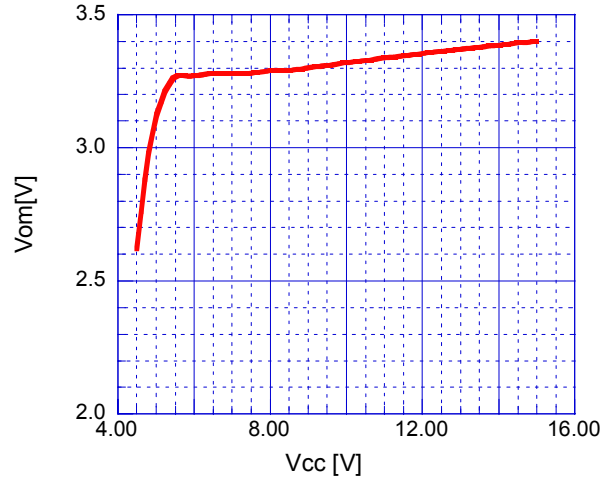

Voltage gain vs. Supply voltage
($V_{in}=100\text{kHz}$, 1.0Vpp , $T_a=25^\circ\text{C}$)

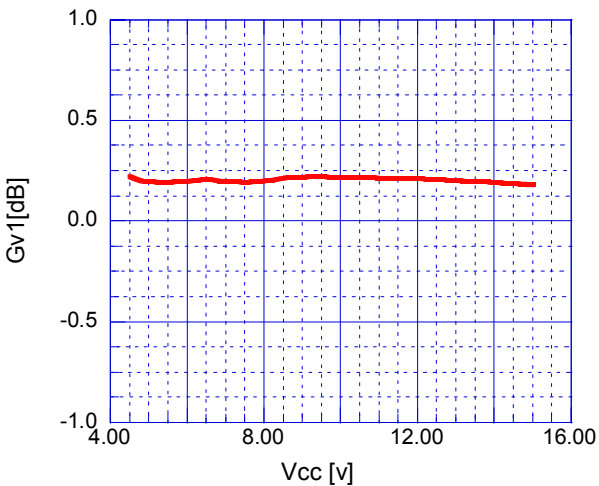

Frequency characteristics vs. Supply voltage
($V_{in}=1.0\text{Vpp}$, $10\text{MHz}/1\text{MHz}$, $T_a=25^\circ\text{C}$)

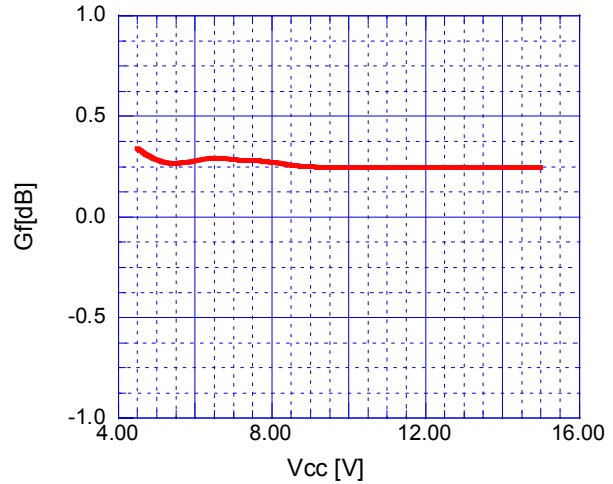

■ TYPICAL CHARACTERISTICS

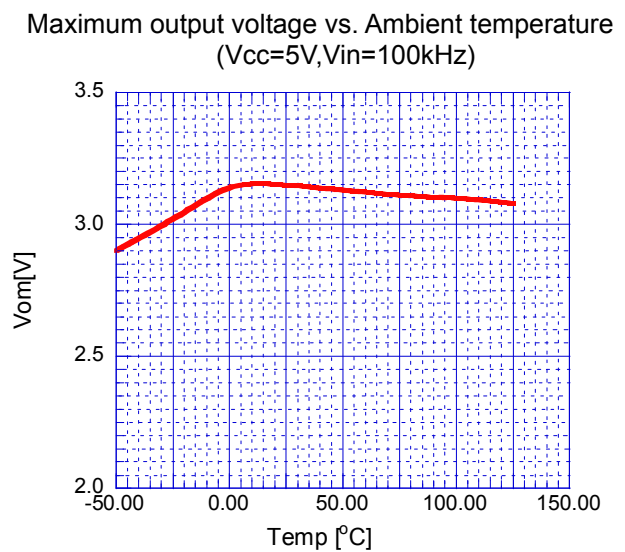
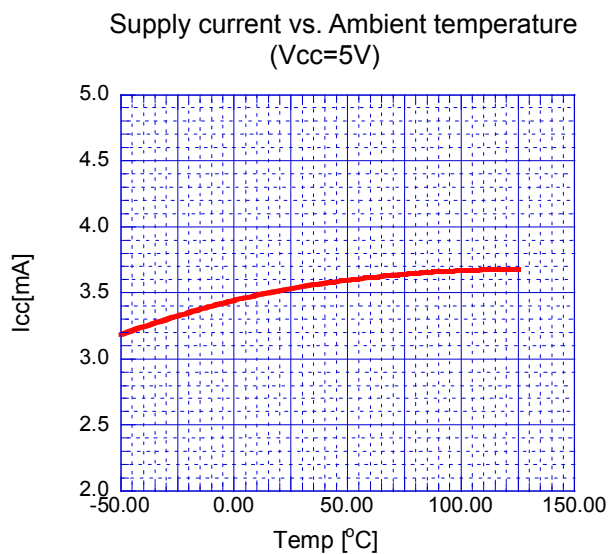
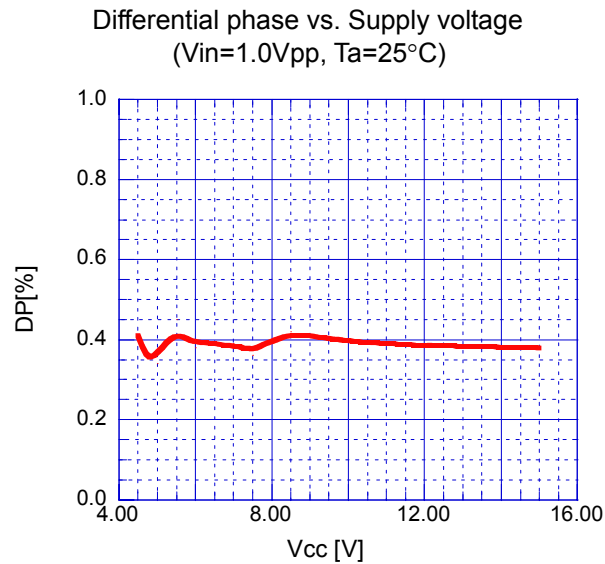
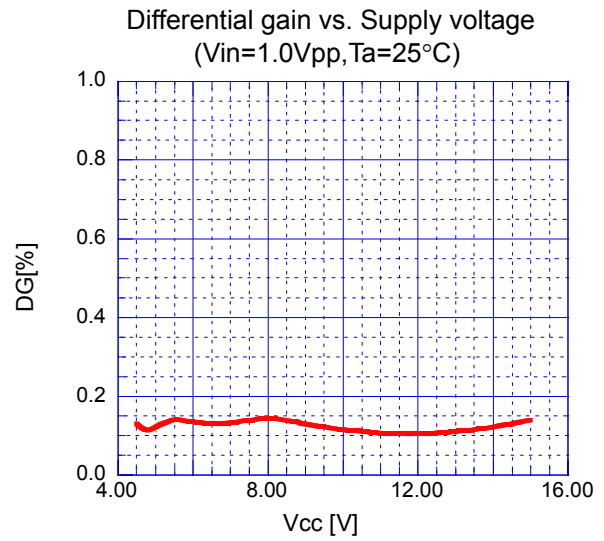
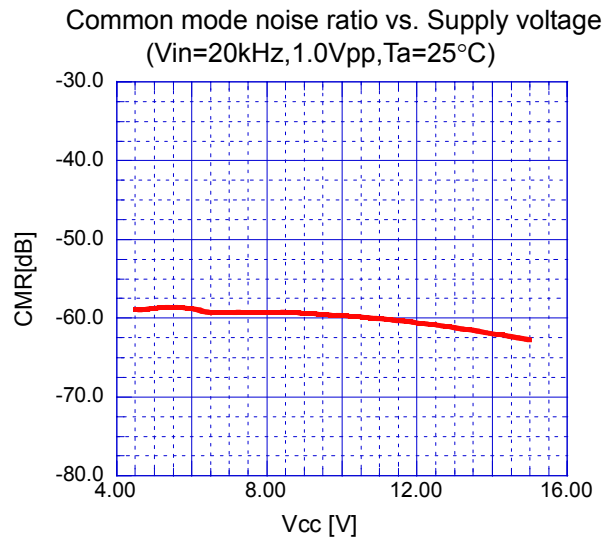

■ TYPICAL CHARACTERISTICS

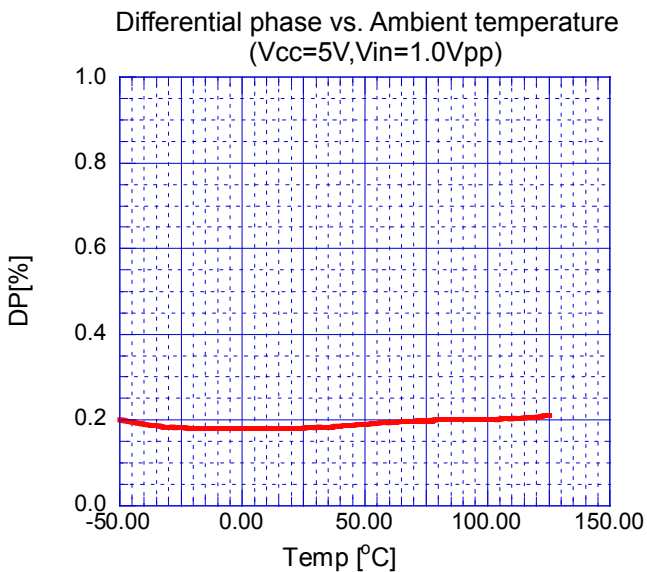
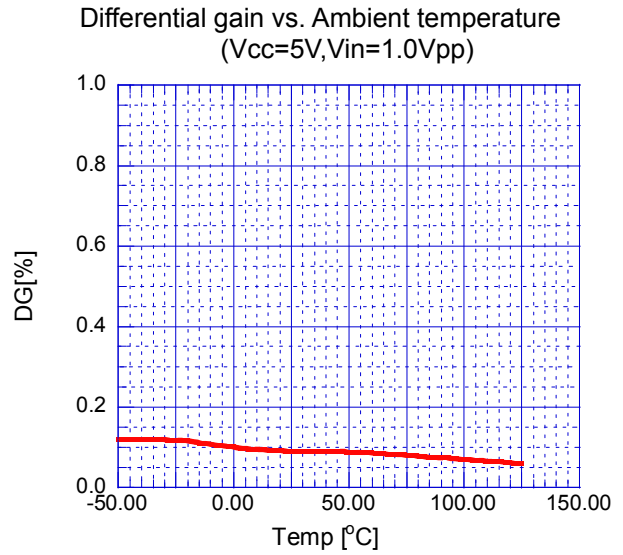
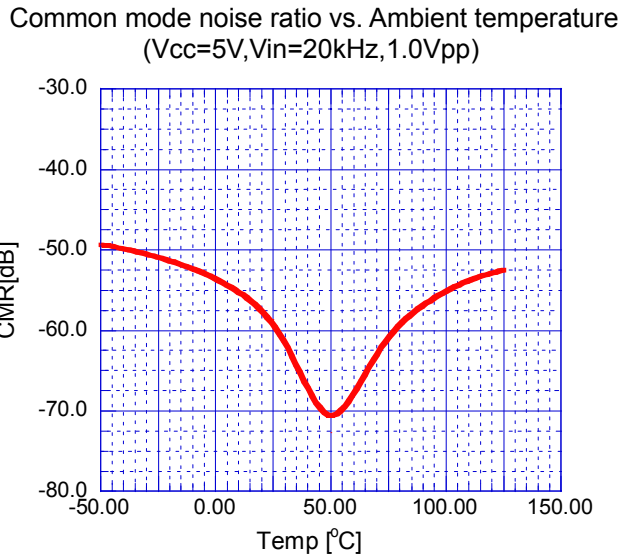
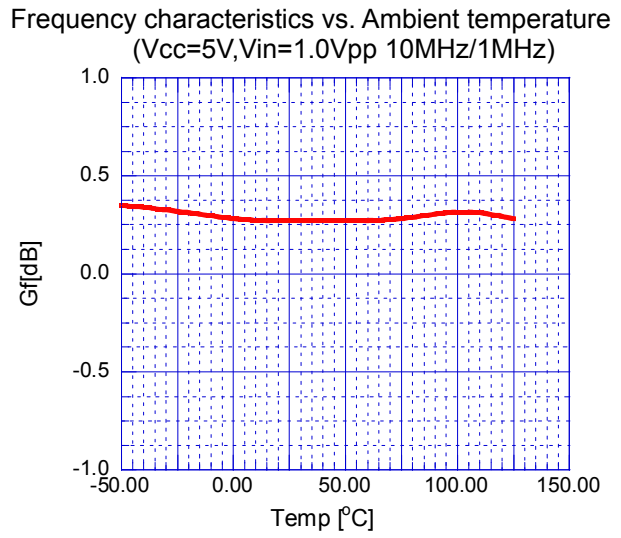
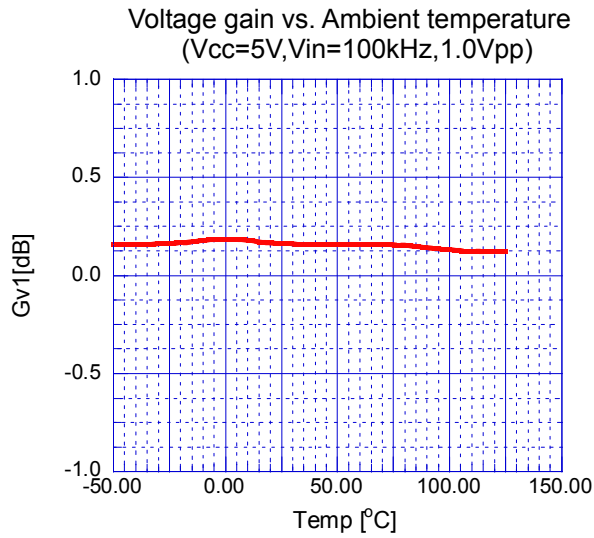

[CAUTION]
The specifications on this databook are only given for information, without any guarantee as regards either mistakes or omissions. The application circuits in this databook are described only to show representative usages of the product and not intended for the guarantee or permission of any right including the industrial rights.

Mouser Electronics

Authorized Distributor

Click to View Pricing, Inventory, Delivery & Lifecycle Information:

[Nisshinbo Micro Devices:](#)

[NJM2505AF-TE1](#) [NJM2505AF-TE2](#)