

# FCC PART68 VOICE/DATA COUPLING TRANSFORMERS

**RoHS**

**FEATURES:**

- \* Designed to meet FCC Part 68
- \* Designed for V.29, V.32, V.32 bis & V.fast apps.
- \* Low Profile Through Hole Packages
- \* 1500 or 3000Vrms Isolation Voltage Available

**GENERAL SPECIFICATIONS:**

Longitudinal Balance:  
 60 to 1000 Hz ..... 60 dB Min.  
 1000 to 4000 Hz ..... 40 dB Min.  
 Turns Ratio (Pri:Sec) ..... 1:1 ± 2%

\* DESIGNED TO MEET SUPPLEMENTARY INSULATION REQUIREMENTS FOR A PRIMARY CIRCUIT AS DEFINED BY IEC-950, EN60950, UL1950/CSA950

**ELECTRICAL SPECIFICATIONS AT 25°C - OPERATING TEMPERATURE RANGE 0°C TO 70°C**

PART NUMBER	Modem Speed up to	Primary DC Current (mA Max)	DCR (h ±15%)		Pri = 600 h with Load of (h)	Ins. Loss @ 1KHz (dB Max.)	Harm Dist @ 300Hz (% Typ.)	Ret Loss @ 1800Hz (dB Min.)	Frequency Response (±dB)		HI-POT Vrms
			Pri	Sec					300-600Hz	600-3500	
PM-MC01	V.29	100	108	120	470	2.5	0.5	13.0	2.5	1.0	1500
PM-MC04	V.29	100	108	120	470	2.5	0.5	13.0	2.5	1.0	3000*
PM-MC02	V.32 bis	0	108	120	374	2.5	0.5	25.0	0.25	0.25	1500
PM-MC03	V.34	0	150	150	301	3.0	0.5	25.0	0.25	0.25	1500
PM-MC05*	V.34, 90	0	164	168	301	3.2	0.5	20.0	0.25	0.25	1875
PM-MC06	V.34	0	155	150	316	3.0	-10**	---	0.5	---	1000

\* PRODUCTION TEST FOR 1 SEC ONLY  
 \*\* @600Hz

**PACKAGE SCHEMATIC**

**PHYSICAL DIMENSIONS ... DIMENSIONS IN mm (inches)**

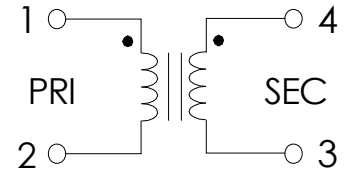
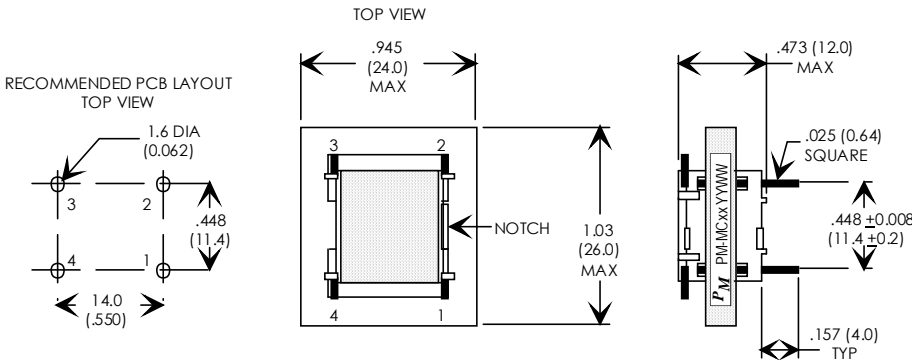

**PHYSICAL DIMENSIONS PM-MC06**

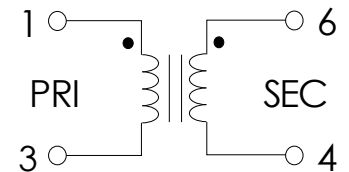
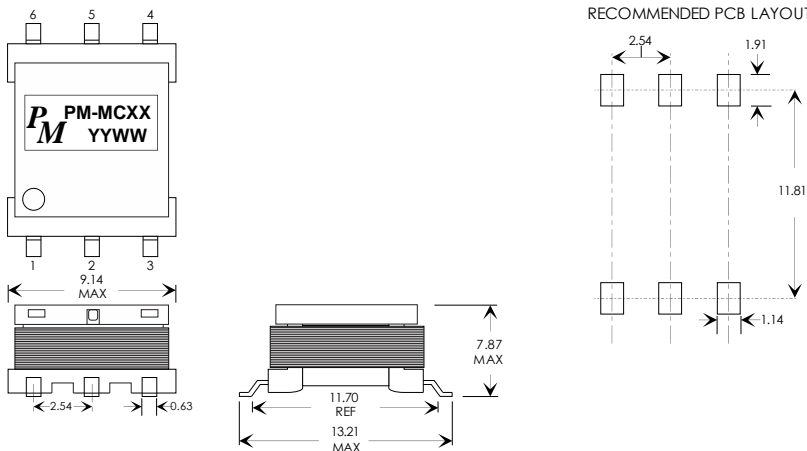

Specifications subject to change without notice.

pmmc06/17

# FCC PART68 VOICE/DATA COUPLING TRANSFORMERS

**RoHS**

**FEATURES:**

- \* Designed to meet FCC Part 68
- \* Designed for V.29, V.32, V.32 bis & V.fast apps.
- \* For 56.6kbps technologies
- \* Developed for PCMCIA Type II Card

**GENERAL SPECIFICATIONS:**

- Longitudinal Balance:
- 200 to 1000 Hz ..... 40 dB Min.
  - 1000 to 4000 Hz ..... 60 dB Min.
  - Turns Ratio (Pri:Sec) ..... 1:1 ± 2%

**ELECTRICAL SPECIFICATIONS AT 25°C - OPERATING TEMPERATURE RANGE 0°C TO 70°C**

PART NUMBER	Modem Speed up to	Primary DC Current (mA Max)	DCR (h ±15%)		Pri = 600 h with Load of (h)	Ins. Loss @ 1KHz (dB Max.)	Harm Dist @ 600Hz (db MAX)	Ret Loss @ 1800Hz (dB Min.)	Frequency Response (±dB) 200Hz - 4000Hz	HI-POT Vrms
			Pri	Sec						
PM-MC10	V.90	0	155	145	297	3.5	-82	14.0	0.20	1650

**PACKAGE**

**SCHEMATIC**

**PHYSICAL DIMENSIONS .... DIMENSIONS IN mm (inches)**

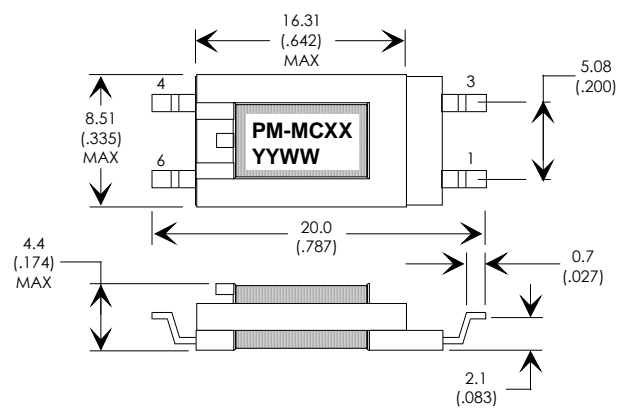

**SCHEMATIC DIAGRAM**

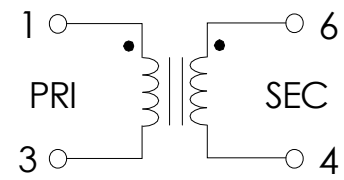

Specifications subject to change without notice.

pmmc06/17

# FCC PART68 VOICE/DATA COUPLING TRANSFORMERS

**RoHS**

**FEATURES:**

- \* Designed to meet FCC Part 68
- \* Designed for V.29, V.32, V.32 bis & V.fast apps.
- \* Low Profile SMD & Through Hole Packages
- \* 1250 & 1500Vrms Isolation Voltage

**GENERAL SPECIFICATIONS:**

Longitudinal Balance:  
 60 to 1000 Hz ..... 60 dB Typ.  
 1000 to 4000 Hz ..... 40 dB Typ.  
 MC26/27 200 to 4000 Hz .....60 dB Typ.  
 Turns Ratio (Pri:Sec) ..... 1:1 ± 2%

**ELECTRICAL SPECIFICATIONS AT 25°C - OPERATING TEMPERATURE RANGE 0°C TO 70°C**

PART NUMBER	Package/ Schematic	Primary DC Current (mA Max)	DCR (h MAX)		Pri = 600 h with Load of (h)	Ins. Loss @ 1KHz (dB Max.)	Harm Dist @ 300Hz (% Typ.)	Ret Loss @ 1000Hz (dB Min.)	Frequency Response (±dB)		HI-POT Vrms
			Pri	Sec					300-600Hz	600-3500	
PM-MC21	ER11-SMD	0	67	88	487	1.50	0.5	15.0	0.50	0.50	1500
PM-MC26*	EP7-THRU	0	68	88	475	1.25	0.5	26.0	0.25	0.25	1250
PM-MC27*	EP7-SMD	0	68	88	475	1.25	0.5	26.0	0.25	0.25	1250

NOTE: \* PRIMARY INDUCTANCE = 700mH MINIMUM

**PACKAGE ER11-SMD**

**SCHEMATIC ER11-SMD**

**PHYSICAL DIMENSIONS .... DIMENSIONS IN mm (inches)**

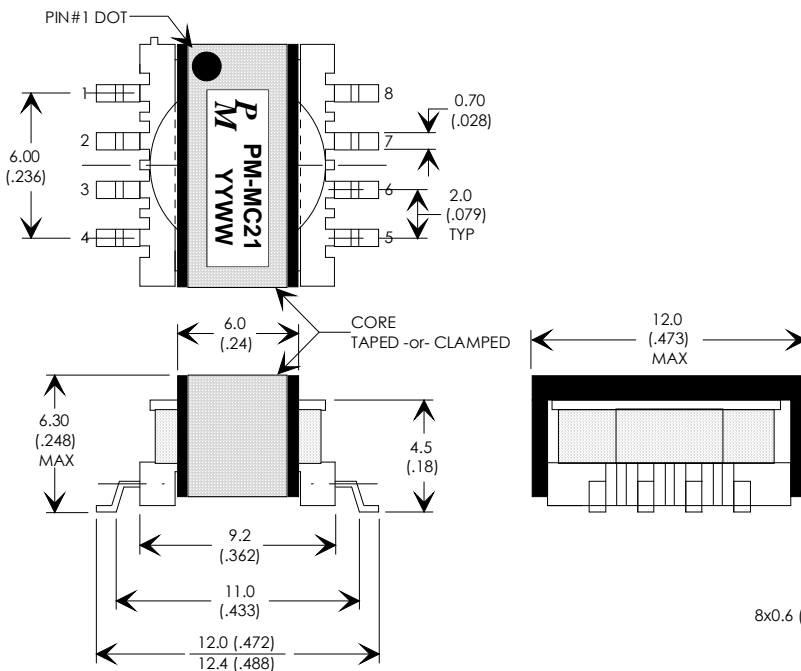

**SCHEMATIC DIAGRAM**

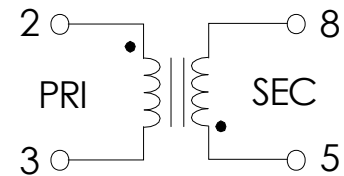

**RECOMMENDED PCB LAYOUT**

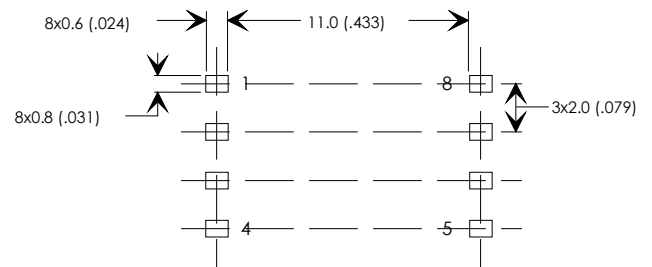

Specifications subject to change without notice.

pmmc06/17

# FCC PART68 VOICE/DATA COUPLING TRANSFORMERS

**RoHS**

**PACKAGE EP7-THRU**

**SCHEMATIC EP7-THRU**

**PHYSICAL DIMENSIONS .... DIMENSIONS IN mm (inches)**

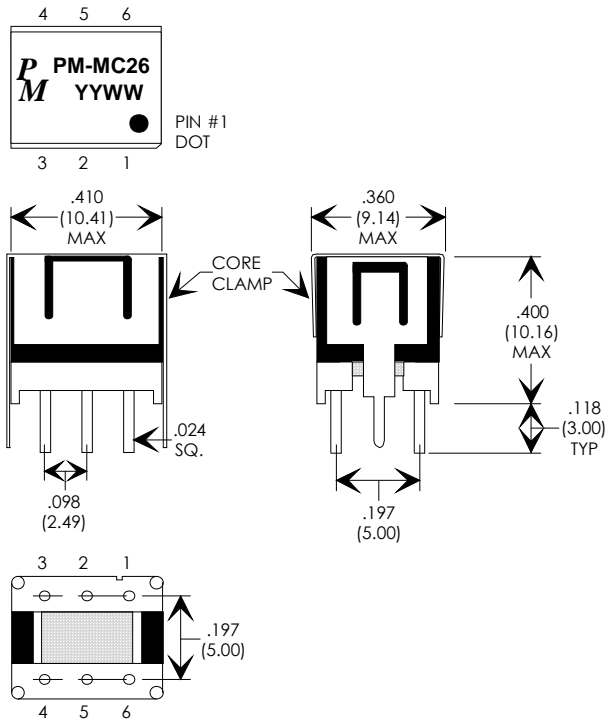

**SCHEMATIC DIAGRAM**

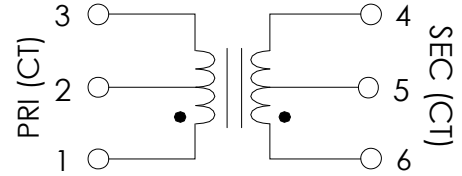

**PACKAGE EP7-SMD**

**SCHEMATIC EP7-SMD**

**PHYSICAL DIMENSIONS .... DIMENSIONS IN mm (inches)**

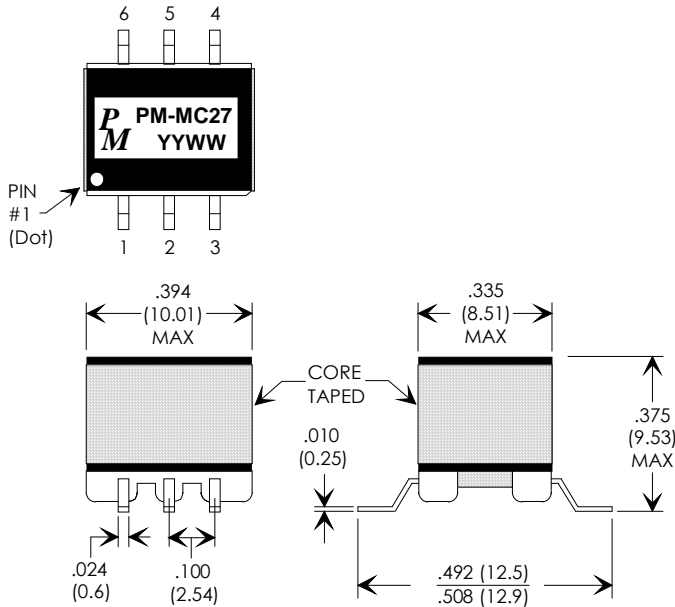

**SCHEMATIC DIAGRAM**

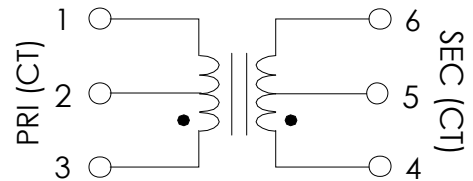

**RECOMMENDED PCB LAYOUT**

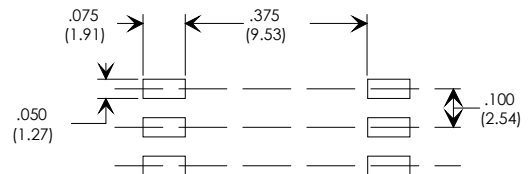

Specifications subject to change without notice.

pmmc06/17

### FEATURES:

- \* Designed to comply with the following requirements as defined by IEC950, EN60950, UL60950/CSA60950 and AS/NZS3260
- \* Supplementary insulation at a 250Vrms

PART NUMBER	Inductance H min	Harmonic Distortion	DCR (h ±15%)		Turn Ratio ±1 %	Ret Loss (dB Min.) 200Hz - 4000Hz	Frequency Response (±dB) 200Hz - 4000Hz	HI-POT Vrms
			Pri	Sec				
PM-MC40	1.6	see note	65	65	1 : 1	20	0.2	1850
PM-MC40A	1.6	see note	65	65	1 : 1	20	0.2	1850

Note: -82dBmax, -88dBtyp @ 600Hz, -10dBm input, 464 Ohm Load, -67 dBtyp @ 150Hz, -3dBm output

### PHYSICAL DIMENSIONS PM-MC40 (2-section Bobbin)

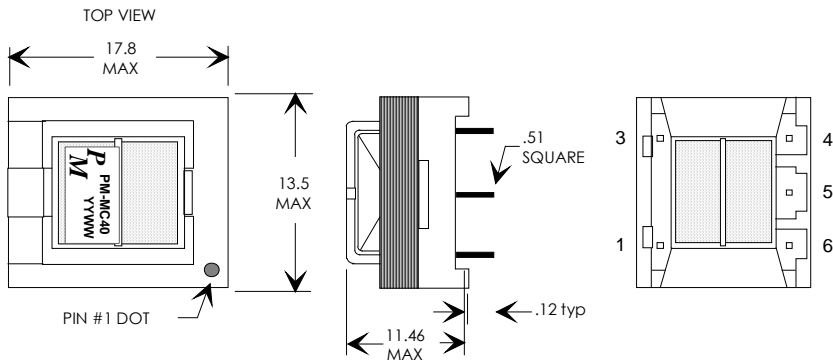

### SCHEMATIC DIAGRAM

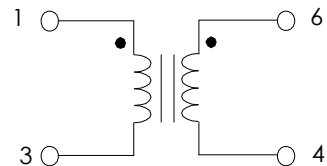

### PHYSICAL DIMENSIONS PM-MC40A (1-section Bobbin)

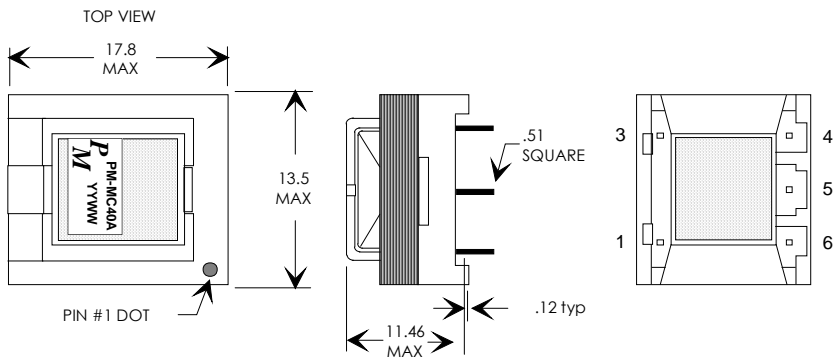

### RECOMMENDED PCB LAYOUT

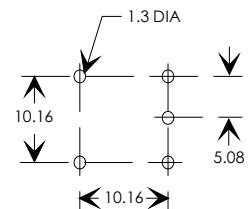

# HI-ISOLATION VOICE/DATA COUPLING TRANSFORMER

**FEATURES:**

- \* Designed to meet BS6305 circuit requirements
- \* Encapsulated Through Hole Package
- \* 3000Vrms Isolation Voltage

**GENERAL SPECIFICATIONS:**

- \* Turns Ratio (Pri:Sec) ..... 1:1 ± 2%
- \* OCL Inductance:  
Lp @ 200Hz, 10mV, 0mAdc ... 2.5H Min.  
Parallel AC Resistance ..... 4 - 12K Ohms

**ELECTRICAL SPECIFICATIONS AT 25°C - OPERATING TEMPERATURE RANGE 0°C TO 70°C**

PART NUMBER	Package/Schematic	Primary DC Current (mA Max)	DCR (h ±15%)		Pri/Sec Impedance w/load=470h 1KHz (h)	Ins. Loss @ 2KHz (dB Max.)	Harm Dist @ 400Hz (dB Max.)	Ret Loss .30 - 4 KHz (dB Min.)	Frequency Response (±dB)		HI-POT Vrms
			Pri	Sec					200-600Hz	600-4000	
PM-MC50	DIP-4	0	70.4	70.4	600/600	1.50	-87	24.0	0.40	0.40	3000

**PACKAGE DIP-4**

**SCHEMATIC DIP-4**

**PHYSICAL DIMENSIONS .... DIMENSIONS IN mm (inches)**

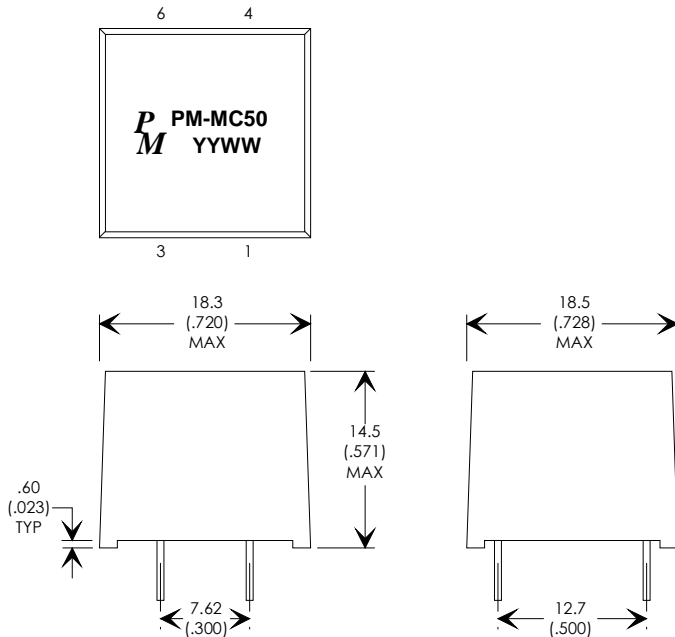

**SCHEMATIC DIAGRAM**

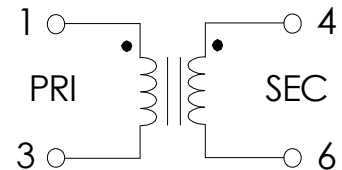

PART IS 100% REVERSABLE  
I.E. IT CAN BE INSERTED INTO THE PCB EITHER WAY

# MODEM MAGNETICS V.90 TRANSFORMER

**FEATURES:**

- \* Designed to meet BS6305 circuit requirements
- \* Encapsulated Through Hole Package
- \* 1500Vrms Isolation Voltage

**GENERAL SPECIFICATIONS:**

Turns Ratio (Pri:Sec) ..... 1:1 ± 2%  
 Matching 600Ω Line to 360Ω Load.

**ELECTRICAL SPECIFICATIONS AT 25°C**

PART NUMBER	Turns Ratio	Ins. Loss @ 1KHz (dB Max.)	Harm Distortion -3dB, 150 Hz (dB Max.)	DCR (n Max)		Ret Loss (dB Min.) 200Hz - 3500Hz	Frequency Response (dB Max.) 100Hz - 4000Hz	Longitudinal Balance (dB Min.) 200Hz - 3500Hz
				Pri	Sec			
PM-MC55	1 : 1	2.1	-75	135	135	20	0.1	60

**PACKAGE DIP-4**

**SCHEMATIC DIP-4**

**PHYSICAL DIMENSIONS .... DIMENSIONS IN mm (inches)**

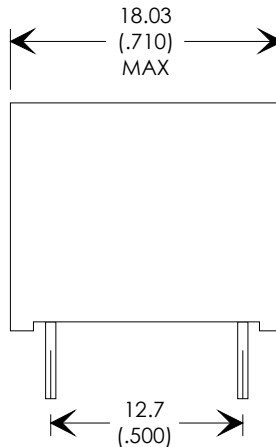
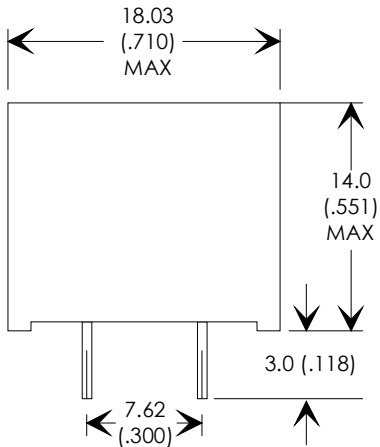

Pin=0.20 (.508) square  
Option Round

**SCHEMATIC DIAGRAM**

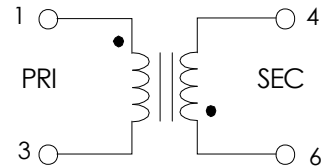

# V.90 LOW DISTORTION VOICE/DATA COUPLING TRANSFORMER

**RoHS**

## FEATURES:

- \* COMPATIBLE WITH V.90 TECHNOLOGY
- \* Low Profile Through Hole Package
- \* 1500 Vrms Isolation Voltage

## GENERAL SPECIFICATIONS:

Longitudinal Balance:  
 200 to 1000 Hz ..... 60 dB Min.  
 1000 to 4000 Hz ..... 40 dB Min.  
 Turns Ratio (Pri:Sec) ..... 1:1 ± 2%

### ELECTRICAL SPECIFICATIONS AT 25°C - OPERATING TEMPERATURE RANGE 0°C TO 70°C

PART NUMBER	Package/Schematic	Primary DC Current (mA Max)	DCR (h ±15%)		Pri/Sec Impedance 1KHz (h)	Ins. Loss @ 1KHz (dB)	Harm Dist @ 600Hz, -10dBm (dB Typ/Max)	Ret Loss .30 - 3 KHz (dB Min.)	Freq Response (±dB) 200Hz-4000Hz	HI-POT Vrms
			Pri	Sec						
PM-MC60	DIP-4	0	108	120	600/374	2 ±.25	-91/-82	15	±.25	1500

### PACKAGE DIP-4

### SCHEMATIC DIP-4

### PHYSICAL DIMENSIONS .... DIMENSIONS IN mm (inches)

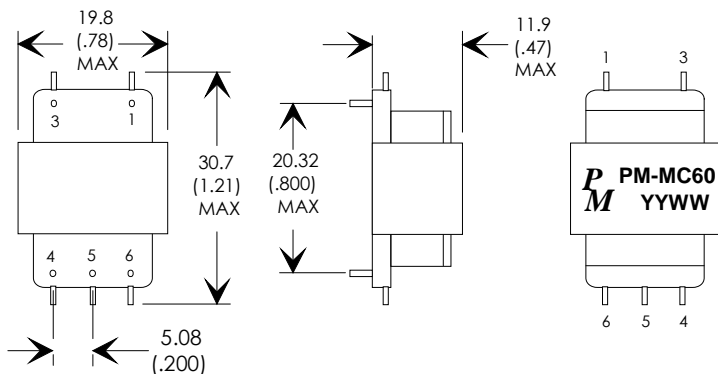

### SCHEMATIC DIAGRAM

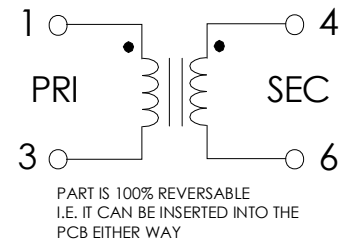



# POCKET/LAPTOP MODEM TRANSFORMERS

**RoHS**

## FEATURES:

- \* Designed to meet FCC Part 68
- \* Designed for V.29, V.32, V.32 bis & V.34 bis.
- \* Small size/ Low cost

## GENERAL SPECIFICATIONS:

Longitudinal Balance:

- 60 to 1000 Hz ..... 60 dB Min.
- 1000 to 4000 Hz -102, 104, 105..... 60 dB Min.
- 1000 to 4000 Hz ..... 40 dB Min.
- Turns Ratio (Pri:Sec) ..... 1:1 ± 2%
- Turns Ratio (Pri:Sec) -101 & 107.....0.92:1 ± 2%

### ELECTRICAL SPECIFICATIONS AT 25°C - OPERATING TEMPERATURE RANGE 0°C TO 70°C

PART NUMBER	Modem Speed up to	Primary DC I	DCR (h ±15%)		Pri = 600 h with Load of (h)	Ins. Loss @ 1KHz (dB Max.)	Harm Dist @ 600Hz (db MAX)	Ret Loss @ 300Hz (dB Min.)	Freq Response (±dB) 300Hz - 3500Hz	HI-POT Vrms	Schematic
			Pri	Sec							
PM-MC101	V.29	0	46.5	67.6	600	1.25	-68	21	0.25	1250	B
PM-MC102	V.29	0	52	59	600	1.50	-68	23	0.50	3750	A
PM-MC103	V.32bis	0	80	87	442	2.0	-76	21	0.25	1250	B
PM-MC104	V.32bis	0	70	75	442	2.0	-76	22	0.50	3750	A
PM-MC105	V.34bis	0	152	151	348	3.25	-83.6	20	0.50	3750	A
PM-MC106	V.34bis	0	135	143	324	3.0	-82	35	0.25	1250	B
PM-MC107	V.32	0	52	75	600	1.15	-71	22	0.20	1250	B
PM-MC108	V.32bis	0	105	105	402	2.25	-76	26	0.13	1250	B
PM-MC109			55	65	600	1.3	-60	18	0.5	3750	A

## PACKAGE

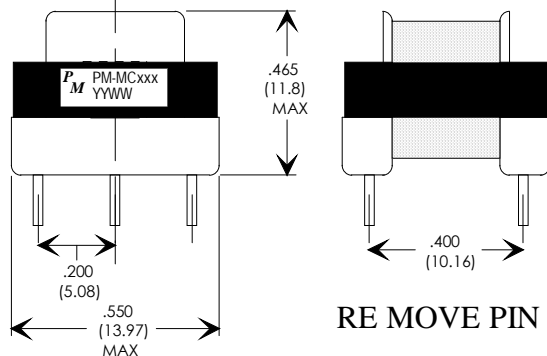
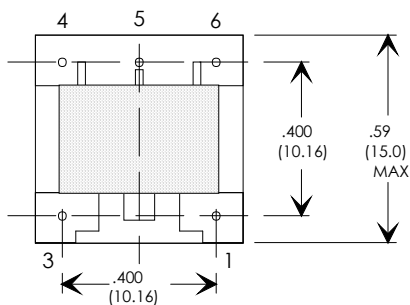

## SCHEMATIC

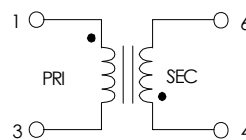

SCHEMATIC "A"

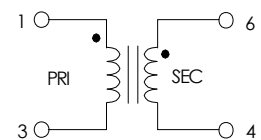

SCHEMATIC "B"





# VOICE/DATA COUPLING TRANSFORMERS

**RoHS**

## CROSS REFERENCE LISTING

<b><u>PREMIER PART#</u></b>	<b><u>X-REF NAME &amp; PART#</u></b>
PM-MC01	MIDCOM 671-8001
PM-MC03	MIDCOM 671-8039,671-8079
PM-MC05	MIDCOM 82098
PM-MC26	MIDCOM 671-5932
PM-MC27	MIDCOM 671-8243
PM-MC50	CRITCHLEY CWC 9000
PM-MC60	MIDCOM 671-8262
PM-MC10	MIDCOM 671-8481
PM-MC102	MIDCOM 671-8240
PM-MC109	ATECH ATS-007
PM-MC40A	MIDCOM 82100 (1-SECTION BOBBIN)
PM-MC40	(2-SECTION BOBBIN)
PM-MC55	Bel 2811B

