



TDA2004

LINEAR INTEGRATED CIRCUIT

10+10W STEREO AMPLIFIER FOR CAR RADIO

DESCRIPTION

The UTC TDA2004 is a class B dual audio power amplifier and is designed for car radio applications.

FEATURES

- * Low distortion.
- * Low noise.

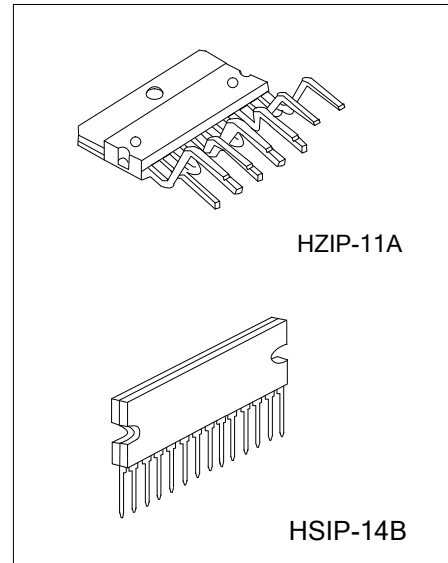

ORDERING INFORMATION

Ordering Number		Package	Packing
Lead Free	Halogen Free		
TDA2004L-J11-A-T	TDA2004G-J11-A-T	HZIP-11A	Tube
TDA2004-H14-B-T	TDA2004G-H14-B-T	HSIP-14B	Tube

<p>TDA2004G-J11-A-T</p> <ul style="list-style-type: none"> (1) Packing Type (2) Package Type (3) Green Package 	<ul style="list-style-type: none"> (1) T: Tube (2) J11-A: HZIP-11A, H14-B: HSIP-14B (3) G: Halogen Free and Lead Free, L: Lead Free
---	--

MARKING

HZIP-11A	HSIP-14B
<p>UTC TDA2004</p> <p>L: Lead Free G: Halogen Free</p> <p>Lot Code ← 1 → Date Code</p>	<p>UTC □□□□ → Date Code TDA2004 □ → L: Lead Free □ → G: Halogen Free □ → Lot Code</p> <p>1</p>

■ PIN CONFIGURATION

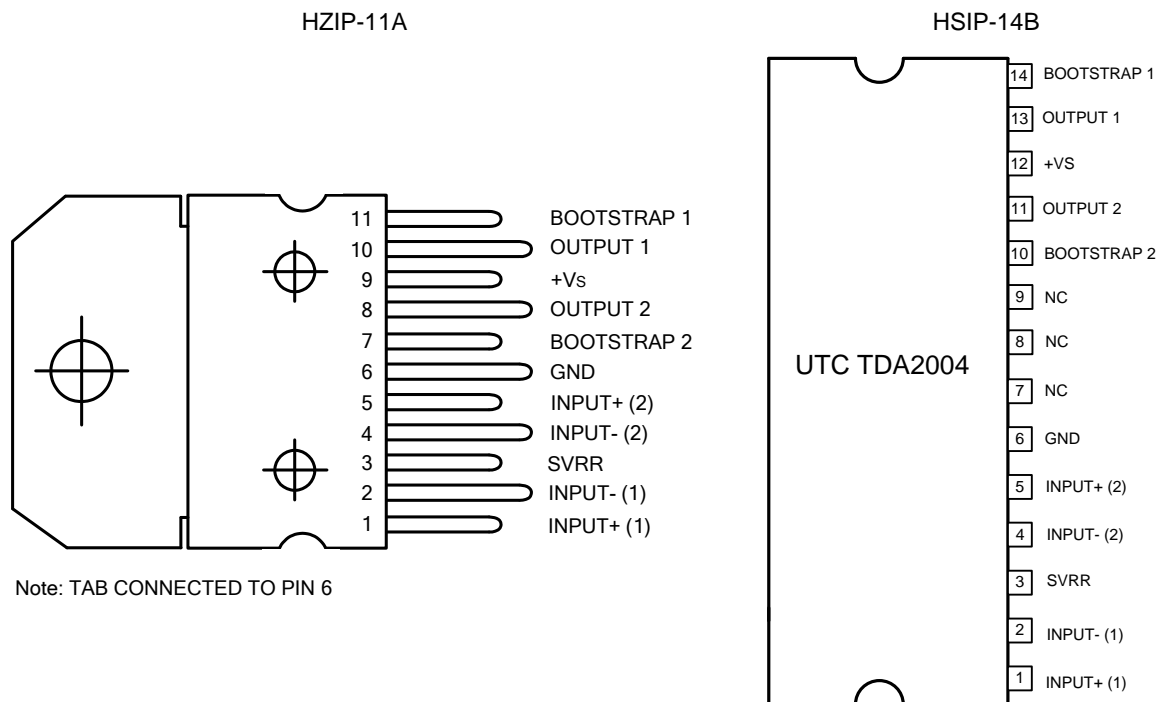

■ PIN DESCRIPTION

PIN NO.		PIN NAME
HZIP-11A	HSIP-14B (Note)	
1	1	INPUT+ (1)
2	2	INPUT- (1)
3	3	SVRR
4	4	INPUT- (2)
5	5	INPUT+ (2)
6	6	GND
7	10	BOOTSTRAP 2
8	11	OUTPUT 2
9	12	+VS
10	13	OUTPUT 1
11	14	BOOTSTRAP 1

Note: PIN 7, 8, 9 no connection.

■ ABSOLUTE MAXIMUM RATINGS

PARAMETER	SYMBOL	RATINGS	UNIT	
Operating Supply Voltage	V_{SS}	18	V	
DC Supply Voltage	V_{SS}	28	V	
Peak Supply Voltage (for 50ms)	V_{SS}	40	V	
Output Peak Current (Note)	non repetitive $t=0.1\text{ms}$	I_o	4.5	A
	repetitive $f \geq 10\text{Hz}$	I_o	3.5	A
Power Dissipation at $T_C=60^\circ\text{C}$	P_D	30	W	
Junction Temperature	T_J	+125	$^\circ\text{C}$	
Storage Temperature	T_{STG}	-40 ~ 150	$^\circ\text{C}$	

Note: The max. output current is internally limited.

■ THERMAL DATA

PARAMETER	SYMBOL	RATINGS	UNIT
Thermal Resistance Junction-Case	θ_{JC}	3.0	$^\circ\text{C/W}$

■ ELECTRICAL CHARACTERISTICS

(Refer to the test circuit, $T_A=25^\circ\text{C}$, $G_V=50\text{Db}$, $R_{th}(\text{heatsink})=4^\circ\text{C/W}$, unless otherwise specified.)

PARAMETER	SYMBOL	TEST CONDITIONS	MIN	TYP	MAX	UNIT
Supply Voltage	V_{SS}		8		18	V
Quiescent Output Voltage	V_{OUT}	$V_{SS}=14.4\text{V}$	6.6	7.2	7.8	V
		$V_{SS}=13.2\text{V}$	6.0	6.6	7.2	V
Total Quiescent Drain Current	I_D	$V_{SS}=14.4\text{V}$		65	120	mA
		$V_{SS}=13.2\text{V}$		62	120	
Stand-by Current	I_{STAY-B}	Pin 3 grounded		5		mA
Output Power (each channel) $f=1\text{KHz}$, $\text{THD}=10\%$	P_{OUT}	$V_{SS}=14.4\text{V}$	$R_L=4\Omega$	6	6.5	W
			$R_L=3.2\Omega$	7	8	W
			$R_L=2\Omega$	9	10 (Note 1)	W
		$V_{SS}=13.2\text{V}$	$R_L=1.6\Omega$	10	11	W
			$R_L=3.2\Omega$	6	6.5	W
			$R_L=1.6\Omega$	9	10	W
		$V_{SS}=16\text{V}$, $R_L=2\Omega$		12	W	
Total Harmonic Distortion (each channel) $f=1\text{KHz}$	THD	$V_{SS}=14.4\text{V}$, $R_L=4\Omega$ $P_{OUT}=50\text{mW} \sim 4\text{W}$		0.2	1	%
		$V_{SS}=14.4\text{V}$, $R_L=2\Omega$ $P_{OUT}=50\text{mW} \sim 6\text{W}$		0.3	1	%
		$V_{SS}=13.2\text{V}$, $R_L=3.2\Omega$ $P_{OUT}=50\text{mW} \sim 3\text{W}$		0.2	1	%
		$V_S=13.2\text{V}$, $R_L=1.6\Omega$ $P_{OUT}=50\text{mW} \sim 6\text{W}$		0.3	1	%
Cross Talk	C_T	$V_{SS}=14.4\text{V}$ $V_{OUT}=4\text{Vrms}$, $R_L=4\Omega$	$f=1\text{KHz}$	50	60	dB
			$f=10\text{kHz}$, $R_G=5\text{K}\Omega$	40	45	dB
Input Saturation Voltage	V_{IN}		300			mV
Input Resistance (non inverting input)	R_{IN}	$f=1\text{kHz}$	70	200		$\text{k}\Omega$
Low Frequency Roll Off (-3dB)	f_L	$R_L=4\Omega$			35	Hz
		$R_L=2\Omega$			50	Hz
		$R_L=3.2\Omega$			40	Hz
		$R_L=1.6\Omega$			55	Hz
High Frequency Roll Off (-3dB)	f_H	$R_L=1.6\Omega \sim 4\Omega$	15			kHz

Notes: 1. 9.3W without Bootstrap

2. Bandwith Filter: 22Hz ~ 22KHz.

■ ELECTRICAL CHARACTERISTICS (Cont.)

PARAMETER	SYMBOL	TEST CONDITONS	MIN	TYP	MAX	UNIT	
Voltage Gain (open loop)	G _v	f=1kHz		90		dB	
Voltage Gain (closed loop)		f=1KHz	48	50	51	dB	
Closed Loop Gain Matching				0.5		dB	
Total Input Noise Voltage	e _N	R _G =10KΩ (Note 2)		1.5	5	μV	
Supply Voltage Rejection	SVR	f _{RIPPLE} =100Hz, R _G =10kΩ C3=10μF, V _{RIPPLE} =0.5Vrms	35	45		dB	
Efficiency	η	V _{SS} =14.4V, f=1kHz	R _L =4Ω, P _O =6.5W		70		%
			R _L =2Ω, P _O =10W		60		%
		V _{SS} =13.2V, f=1kHz	R _L =3.2Ω, P _O =6.5W		70		%
			R _L =1.6Ω, P _O =10W		60		%
Thermal Shut-down Junction Temperature	T _J			145		°C	

Notes: 1. 9.3W without Bootstrap

2. Bandwith Filter: 22Hz ~ 22KHz.

■ TEST AND APPLICATION CIRCUIT

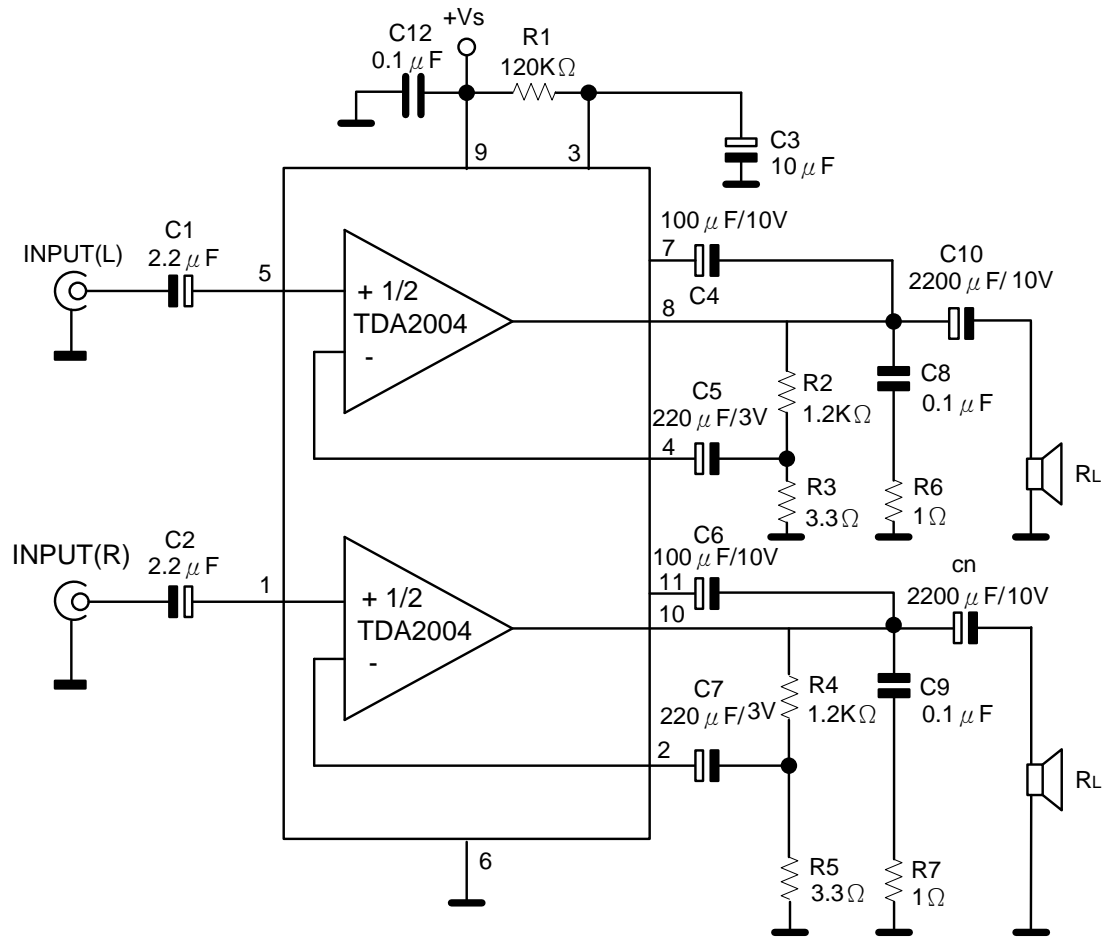

TYPICAL CHARACTERISTICS

Figure 1. Quiescent Output Voltage vs. Supply Voltage

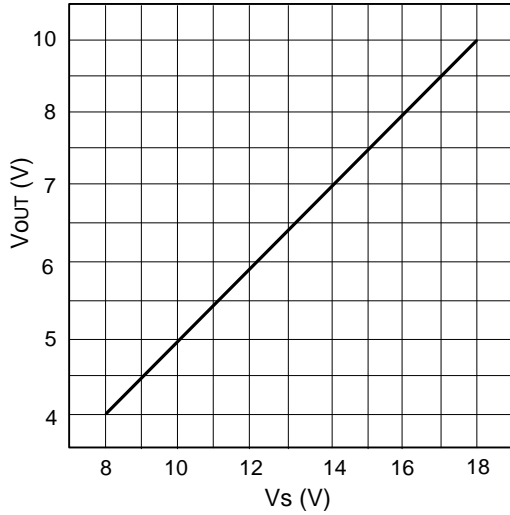

Figure 2. Quiescent Drain Current vs. Supply Voltage

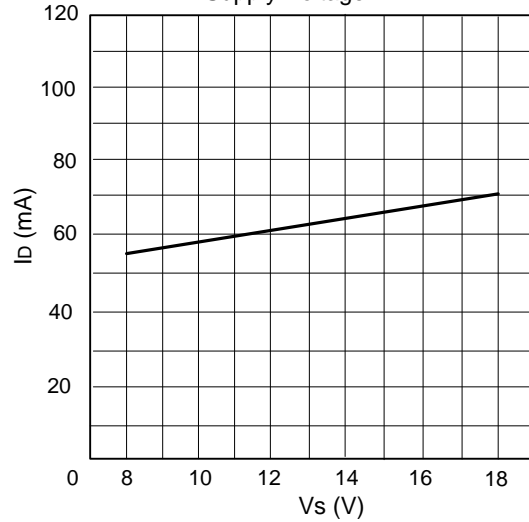

Figure 3. Distortion vs. Output Power

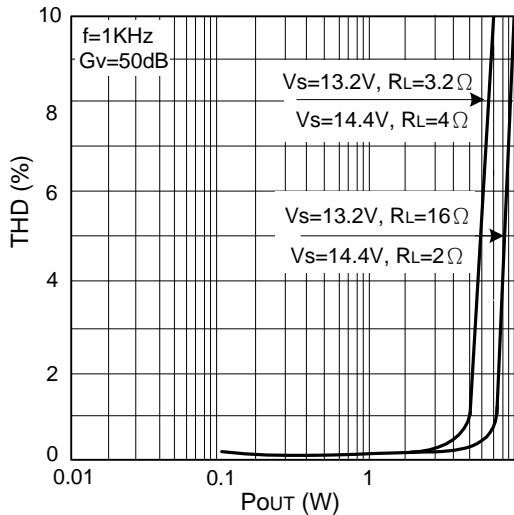

Figure 4. Output Power vs. Supply Voltage

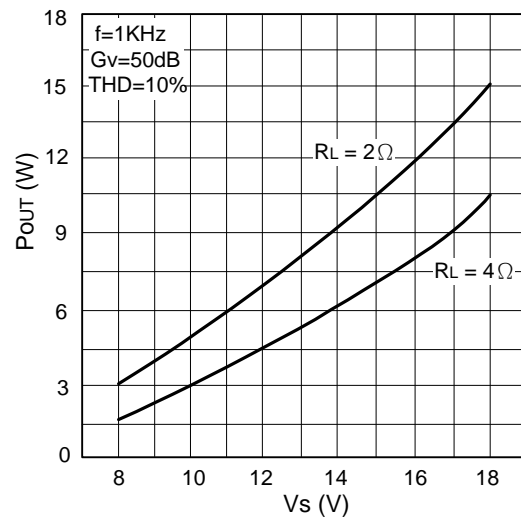

Figure 5. Output Power vs. Supply Voltage

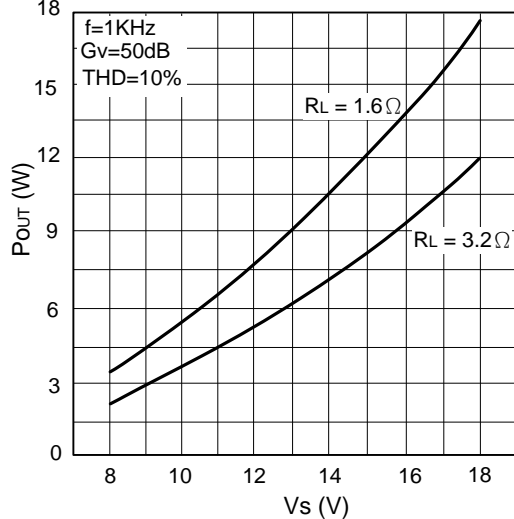
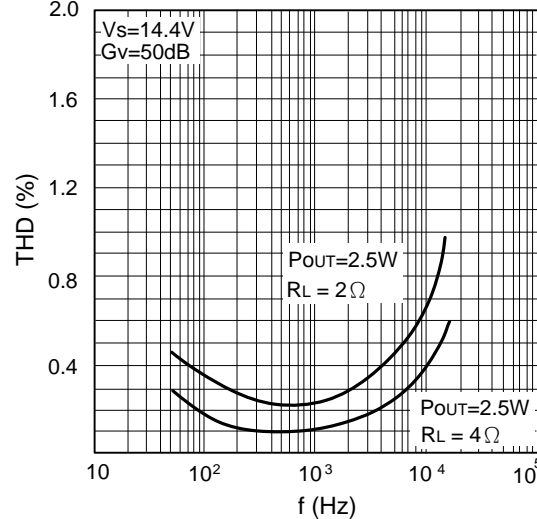

Figure 6. Distortion vs Frequency



■ TYPICAL CHARACTERISTICS (cont.)

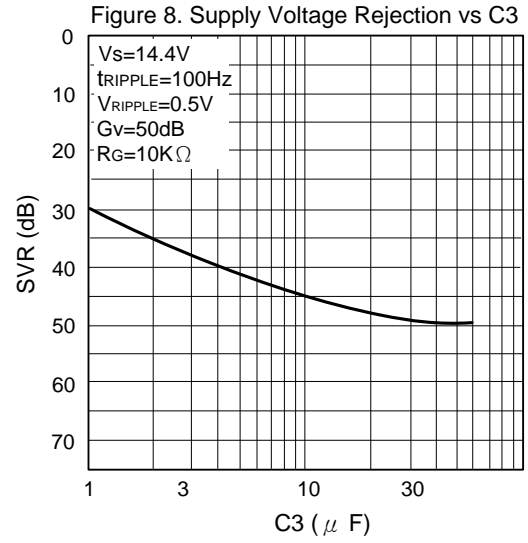
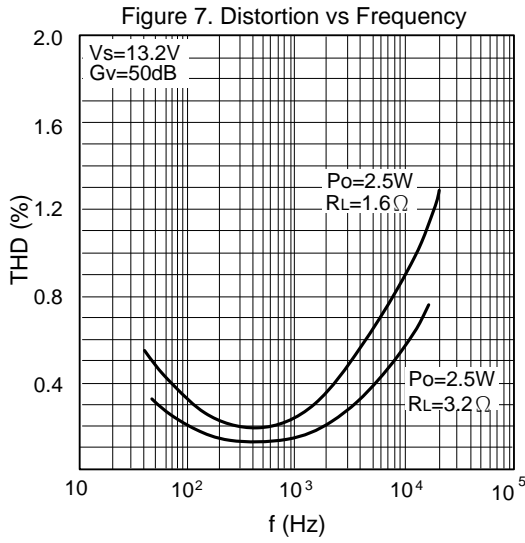

Figure 9. Supply Voltage Rejection vs. Frequency.

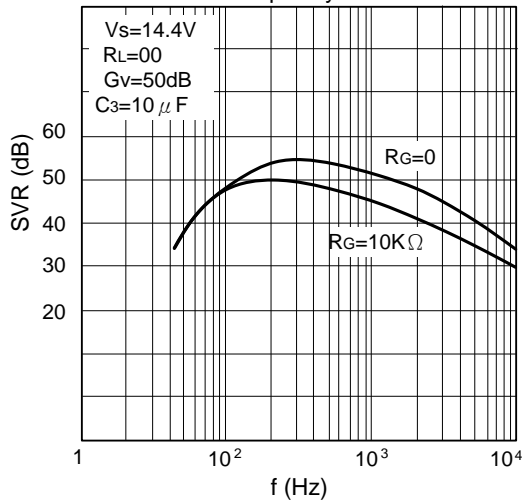

Figure 10. Supply Voltage Rejection vs. Values of Capacitors C2 and C3

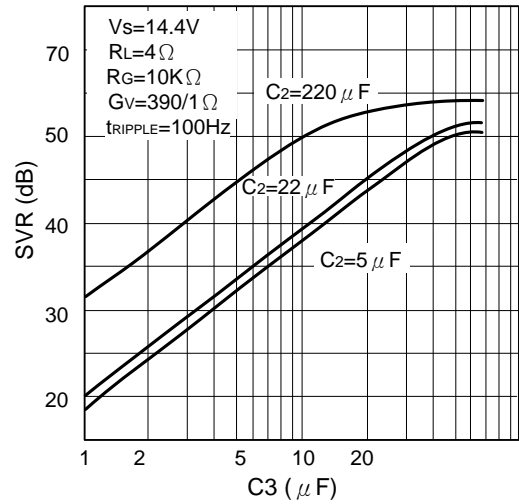

Figure 11. Supply Voltage Rejection vs. Values of Capacitors C2 and C3

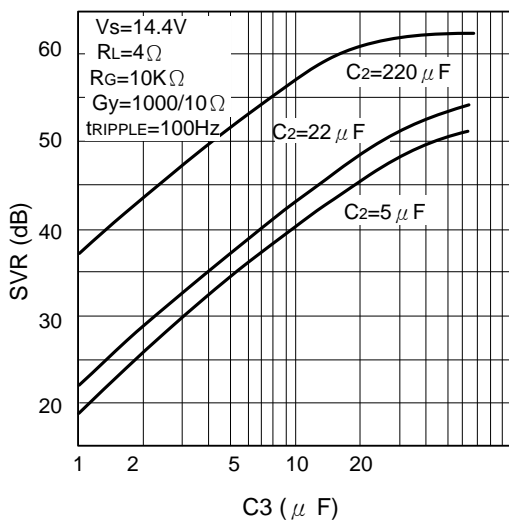
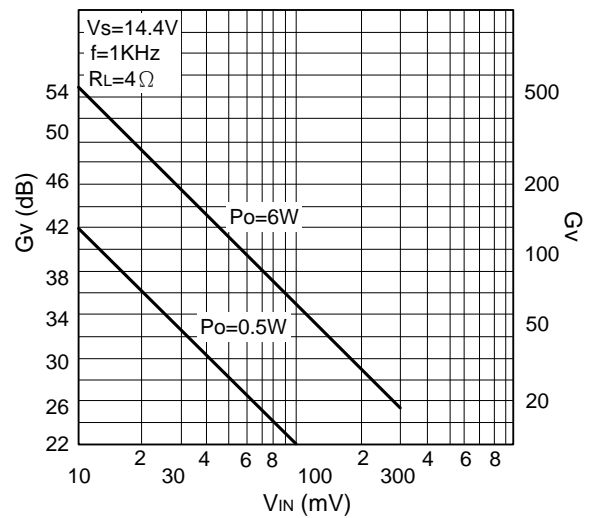

Figure 12. Gain vs. Input Sensitivity



■ TYPICAL CHARACTERISTICS (cont.)

Figure 13. Maximum Allowable Power Dissipation vs. Ambient Temperature

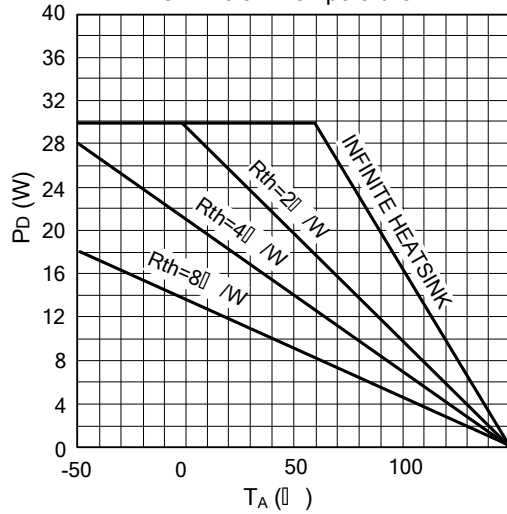

Figure 14. Total Power Dissipation and Efficiency vs. Output Power

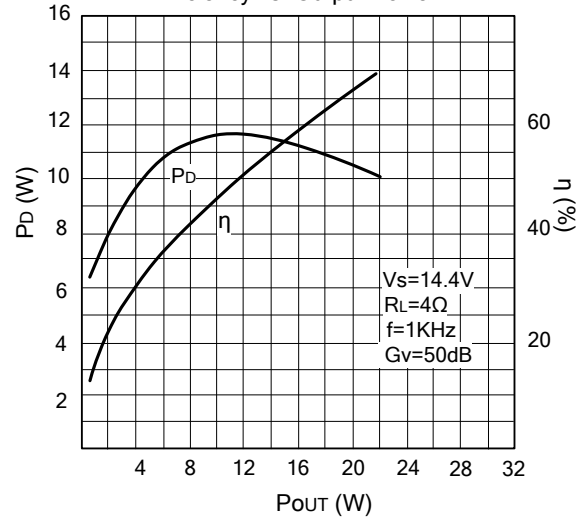
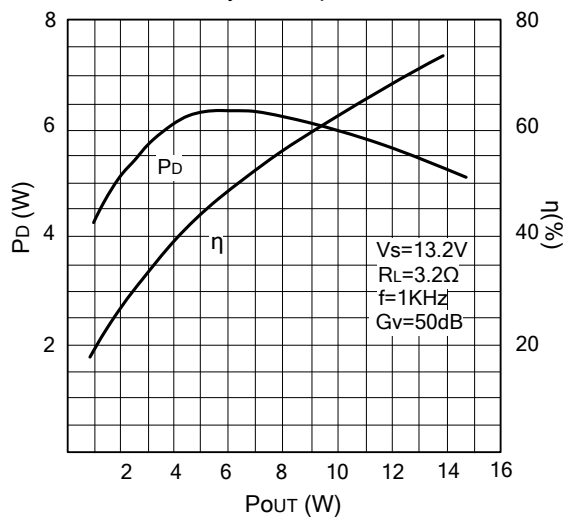

Figure 15. Total Power Dissipation and Efficiency vs. Output Power



UTC assumes no responsibility for equipment failures that result from using products at values that exceed, even momentarily, rated values (such as maximum ratings, operating condition ranges, or other parameters) listed in products specifications of any and all UTC products described or contained herein. UTC products are not designed for use in life support appliances, devices or systems where malfunction of these products can be reasonably expected to result in personal injury. Reproduction in whole or in part is prohibited without the prior written consent of the copyright owner. UTC reserves the right to make changes to information published in this document, including without limitation specifications and product descriptions, at any time and without notice. This document supersedes and replaces all information supplied prior to the publication hereof.