

1.1 Overview

The MN103H is a 32-bit microcontroller combining ease of use intended for programs development in the C language with a simple, high-performance architecture made possible through pursuit of cost performance.

Built around a compact 32-bit CPU with a basic instruction word length of 1 byte, this LSI includes internal memory for instructions and data, DMA controller, a clock generator, bus controller, interrupt controller, watchdog timer, standard peripheral circuitry such as timers and serial interfaces, PWM circuit best suited to controlling 3-phase motors, arithmetic unit for speed-up of inverter control and analog circuits (A/D converters and VGA (Variable Gain Amplifier)) for motor position control. The MN103H Series' high-speed CPU coupled with abundance of peripheral features provides an easy means of developing on LSI for motor and power control applications requiring fast response - a feature previously unavailable with conventional microcontrollers.

1.2 Product Summary

This manual describes LSIs in the following Table:1.2.1.

Table:1.2.1 Product Summary

LSI	ROM size	RAM size (Data RAM+Instruction RAM)	Classification	Package
MN103HF48X / HF58X	384 KB	40 KB (20 KB + 20 KB)	Flash EEPROM version	144 pin LQFP (20 mm square / 0.5 mm pitch)
MN103HF48M / HF58M	384 KB	32 KB (12 KB + 20 KB)	Flash EEPROM version	
MN103HF47X / HF57X	384 KB	40 KB (20 KB + 20 KB)	Flash EEPROM version	128 pin LQFP (18 mm square / 0.5 mm pitch)
MN103HF47M / HF57M	384 KB	32 KB (12 KB + 20 KB)	Flash EEPROM version	
MN103HF46X / HF56X	384 KB	40 KB (20 KB + 20 KB)	Flash EEPROM version	100 pin LQFP (14 mm square / 0.5 mm pitch)
MN103HF46M / HF56M	384 KB	32 KB (12 KB + 20 KB)	Flash EEPROM version	
MN103HF46Z / HF56Z	256 KB	32 KB (16 KB + 16 KB)	Flash EEPROM version	
MN103HF46K / HF56K	256 KB	24 KB (8 KB + 16 KB)	Flash EEPROM version	
MN103HF45X / HF55X	384 KB	40 KB (20 KB + 20 KB)	Flash EEPROM version	80 pin TQFP (12 mm square / 0.5 mm pitch)
MN103HF45M / HF55M	384 KB	32 KB (12 KB + 20 KB)	Flash EEPROM version	
MN103HF45Z / HF55Z	256 KB	32 KB (16 KB + 16 KB)	Flash EEPROM version	
MN103HF45K / HF55K	256 KB	24 KB (8 KB + 16 KB)	Flash EEPROM version	
MN103HF45G* / HF55G*	128 KB	18 KB (6 KB + 12 KB)	Flash EEPROM version	
MN103HF45D* / HF55D*	64 KB	12 KB (4 KB + 8 KB)	Flash EEPROM version	
MN103HF44X / HF54X	384 KB	40 KB (20 KB + 20 KB)	Flash EEPROM version	64 pin TQFP (10 mm square / 0.5 mm pitch)
MN103HF44M / HF54M	384 KB	32 KB (12 KB + 20 KB)	Flash EEPROM version	
MN103HF44Z / HF54Z	256 KB	32 KB (16 KB + 16 KB)	Flash EEPROM version	
MN103HF44K / HF54K	256 KB	24 KB (8 KB + 16 KB)	Flash EEPROM version	
MN103HF44G* / HF54G*	128 KB	18 KB (6 KB + 12 KB)	Flash EEPROM version	
MN103HF44D* / HF54D*	64 KB	12 KB (4 KB + 8 KB)	Flash EEPROM version	

* Under development



This LSI manual is written names of LSI in Table:1.2.1 the following two series names.

- MN103HFx4 series, MN103HFx5 series,
MN103HFx6 series, MN103HFx7 series, MN103HFx8 series
- MN103HF4y series, MN103HF5y series

The function comparisons in this series is listed in Table:1.2.2.

Table:1.2.2 Function Comparisons in MN103HF4y/HF5y Series

Function		MN103HF4y/HF5y Series				
Number of PINs		144 PIN	128 PIN	100 PIN	80 PIN	64 PIN
Extended arithmetic unit (high-speed multiplication/division, trigonometric function, Nth Multiply-accumulate operation, PI control operation)		0	0	0	0	0
DMA		3	3	3	3	3
Interrupt	Internal interrupt	123	123	98	98	84
	External interrupt	16	16	16	12	10
8-bit timer	Timer 0	0	0	0	0	0
	Timer 1	0	0	0	0	0
	Timer 2	0	0	0	0	0
	Timer 3	0	0	0	0	0
	Timer 4	0	0	0	0	0
	Timer 5	0	0	0	0	0
	Timer 6	0	0	0	0	0
	Timer 7	0	0	0	0	0
	Timer 8	0	0	0	0	0
	Timer 9	0	0	0	0	0
	Timer 10	0	0	0	0	0
	Timer 11	0	0	0	0	0
	Timer 12	0	0	-	-	-
	Timer 13	0	0	-	-	-
	Timer 14	0	0	-	-	-
	Timer 15	0	0	-	-	-
	Timer 26	0	0	-	-	-
Timer 27	0	0	-	-	-	
Timer 28	0	0	-	-	-	
Timer 29	0	0	-	-	-	

Function		MN103HF4y/HF5y Series				
Number of PINs		144 PIN	128 PIN	100 PIN	80 PIN	64 PIN
16-bit Timer	Timer 16 (High resolution output of PWM)	0	0	0	0	0
	Timer 17 (High resolution output of PWM)	0	0	0	0	0
	Timer 18 (High resolution output of PWM)	0	0	0	0	0
	Timer 19 (High resolution output of PWM)	0	0	0	0	0
	Timer 20	0	0	0	0	0
	Timer 21	0	0	0	0	0
	Timer 22	0	0	0	0	-
	Timer 23	0	0	0	0	-
	Timer 24 (High resolution output of PWM)	0	0	-	-	-
	Timer 25 (High resolution output of PWM)	0	0	-	-	-
PWM	Complementary 3-phase PWM	3	3	2	2	2
Watchdog timer (external oscillation)		0	0	0	0	0
Watchdog timer2 (internal oscillation)		0	0	0	0	0
CAN		0	0	0	0	0
Serial	Serial 0 (Serial interface clock synchronous / UART / IIC)	0	0	0	0	0
	Serial 1 (Serial interface clock synchronous / UART / LIN)	0	0	0	0	0
	Serial 2 (Serial interface clock synchronous / UART)	0	0	0	0	-
	Serial 3 (Serial interface clock synchronous / UART)	0	0	0	0	0
	Serial 4 (Serial interface clock synchronous / UART)	0	0	-	-	-
A/D converter	A/D0(12 bit)	0 (12 ch)	0 (12 ch)	0 (12 ch)	0 (12 ch)	0 (8 ch)
	A/D1(12 bit)	0 (12 ch)	0 (12 ch)	0 (10 ch)	0 (8 ch)	0 (8 ch)
	A/D2(10 bit)	0 (20 ch)	0 (20 ch)	0 (12 ch)	0 (8 ch)	-

Function		MN103HF4y/HF5y Series				
Number of PINs		144 PIN	128 PIN	100 PIN	80 PIN	64 PIN
VGA	VGA0	-/0	-/0	-/0	-/0	-/0
	VGA1	-/0	-/0	-/0	-/0	-/0
	VGA2	-/0	-/0	-/0	-/0	-/-
Comparator	Comparator0	0	0	0	0	0
	Comparator1	0	0	0	0	0
	Comparator2	0	0	0	0	-
D/A converter	D/A0(10 bit)	0	0	0	0	0
	D/A1(10 bit)	0	0	0	0	0
	D/A2(10 bit)	0	0	0	0	-
Power supply voltage detection function		0	0	0	0	0
Auto reset circuit		0	0	0	0	0
Clock monitoring function		0	0	0	0	0
General ports	I/O port	112	100	74	54	46
	Input port	12	12	10	10	4
Special pin	Reset input pin	1	1	1	1	1
	Oscillation pin	2	2	2	2	2
	Test mode input pin	2	2	2	2	2
	Power pin	9	9	9	9	7
	On-board debugger pin	2	2	2	2	2

1.3 Hardware Functions

■ CPU Core (MN103S core)

- 4 GB of memory space (for instructions / data)
- LOAD/STORE architecture with 5-stage pipeline
- 46 basic instructions + 23 extended arithmetic instructions
- 6 addressing modes
- Instruction set of 1 byte in word length
- Extended arithmetic unit incorporated (high-speed multiply/divide instructions, trigo-nometric function, Nth Multiply-accumulate operation, PI control operation)
- Machine cycle: 8.33 ns (oscillation frequency: 10 MHz, 12 multiplying)
- Operation mode: NORMAL mode, SLEEP mode, HALT mode, STOP mode

■ Oscillation Circuit

- External high-speed oscillation (crystal/ ceramic)
- Internal low-speed oscillation for Watchdog timer 2 (240 kHz)

■ Clock Multiplication Circuit

- High-speed oscillation is multiplied by 6 to 30

■ Internal Memory

- ROM 384 KB to 64 KB
- RAM 40 KB to 12 KB

■ DMA Controller

- Channel:3 ch
- Transfer requests:
 - External interrupts, Timer, PWM, Serial, IIC, CAN, A/D converter, Software
- Transfer mode:3 modes (One word transfer / Burst transfer / Intermittent transfer)

■ Interrupts

- Internal interrupts
- Factors:
 - Timer, PWM, UART, IIC, Synchronous serial, CAN, LIN, A/D converter, Comparator detection, DMA, Watchdog timer, Power supply voltage detection, System error, Fail safe function (Watchdog timer2, Clock error, Register protect, Task overflow)
- External interrupts

■ Timer Counter

- Timer 0 (8-bit timer)
- Function:
 - Interval timer, Timer pulse output, Event count, Baud rate timer
- Count clock source:
 - IOCLK, IOCLK/8, IOCLK/32, IOCLK/128, TM0IO pin input, Timer 1 underflow, Timer 2 underflow

Timer 1 (8-bit timer)

Functions:

Interval timer, Timer pulse output, Event count, Baud rate timer,
Cascade connection

Count clock source:

IOCLK, IOCLK/8, IOCLK/32, IOCLK/128, TM1IO pin input,
Timer 0 underflow, Timer 2 underflow

Timer 2 (8-bit timer)

Functions:

Interval timer, Timer pulse output, Event count, Baud rate timer,
Cascade connection

Count clock source:

IOCLK, IOCLK/8, IOCLK/32, IOCLK/128, TM2IO pin input,
Timer 0 underflow, Timer 1 underflow

Timer 3 (8-bit timer)

Functions:

Interval timer, Timer pulse output, Event count, Baud rate timer,
Cascade connection

Count clock source:

IOCLK, IOCLK/8, IOCLK/32, IOCLK/128,
Timer 0 underflow, Timer 1 underflow, Timer 2 underflow

Timer 4 (8-bit timer)

Functions:

Interval timer, Timer pulse output, Event count

Count clock source:

IOCLK, IOCLK/8, IOCLK/32, IOCLK/128, TM4IO pin input,
Timer 5 underflow, Timer 6 underflow

Timer 5 (8-bit timer)

Functions:

Interval timer, Timer pulse output, Event count, Cascade connection

Count clock source:

IOCLK, IOCLK/8, IOCLK/32, IOCLK/128, TM5IO pin input,
Timer 4 underflow, Timer 6 underflow

Timer 6 (8-bit timer)

Functions:

Interval timer, Timer pulse output, Event count, Cascade connection

Count clock source:

IOCLK, IOCLK/8, IOCLK/32, IOCLK/128, TM6IO pin input,
Timer 4 underflow, Timer 5 underflow

Timer 7 (8-bit timer)

Functions:

Interval timer, Timer pulse output, Event count, Cascade connection

Count clock source:

IOCLK, IOCLK/8, IOCLK/32, IOCLK/128, TM7IO pin input,
Timer 4 underflow, Timer 5 underflow, Timer 6 underflow

Timer 8 (8-bit timer)

Functions:

Interval timer, Timer pulse output, Event count

Count clock source:

IOCLK, IOCLK/8, IOCLK/32, IOCLK/128, TM8IO pin input,

Timer 9 underflow, Timer 10 underflow

Timer 9 (8-bit timer)

Functions:

Interval timer, Timer pulse output, Event count, Cascade connection

Count clock source:

IOCLK, IOCLK/8, IOCLK/32, IOCLK/128, TM9IO pin input,

Timer 8 underflow, Timer 10 underflow

Timer 10 (8-bit timer)

Functions:

Interval timer, Timer pulse output, Event count, Cascade connection

Count clock source:

IOCLK, IOCLK/8, IOCLK/32, IOCLK/128, TM10IO pin input,

Timer 8 underflow, Timer 9 underflow

Timer 11 (8-bit timer)

Functions:

Interval timer, Timer pulse output, Event count, Cascade connection

Count clock source:

IOCLK, IOCLK/8, IOCLK/32, IOCLK/128, TM11IO pin input,

Timer 8 underflow, Timer 9 underflow, Timer 10 underflow

Timer 12 (8-bit timer)

Functions:

Interval timer, Timer pulse output, Event count

Count clock source:

IOCLK, IOCLK/8, IOCLK/32, IOCLK/128, TM12IO pin input,

Timer 13 underflow, Timer 14 underflow

Timer 13 (8-bit timer)

Functions:

Interval timer, Timer pulse output, Event count, Cascade connection

Count clock source:

IOCLK, IOCLK/8, IOCLK/32, IOCLK/128, TM13IO pin input,

Timer 12 underflow, Timer 14 underflow

Timer 14 (8-bit timer)

Functions:

Interval timer, Timer pulse output, Event count, Cascade connection

Count clock source:

IOCLK, IOCLK/8, IOCLK/32, IOCLK/128, TM14IO pin input,

Timer 12 underflow, Timer 13 underflow

Timer 15 (8-bit timer)

Functions:

Interval timer, Timer pulse output, Event count, Cascade connection

Count clock source:

IOCLK, IOCLK/8, IOCLK/32, IOCLK/128, TM15IO pin input,

Timer 12 underflow, Timer 13 underflow, Timer 14 underflow

Timer 26 (8-bit timer)

Functions:

Interval timer, Timer pulse output, Event count, Baud rate timer

Count clock source:

IOCLK, IOCLK/8, IOCLK/32, IOCLK/128, TM26IO pin input,

Timer 27 underflow, Timer 28 underflow

Timer 27 (8-bit timer)

Functions:

Interval timer, Timer pulse output, Event count, Baud rate timer,

Cascade connection

Count clock source:

IOCLK, IOCLK/8, IOCLK/32, IOCLK/128, TM27IO pin input,

Timer 26 underflow, Timer 28 underflow

Timer 28 (8-bit timer)

Functions:

Interval timer, Timer pulse output, Event count, Cascade connection

Count clock source:

IOCLK, IOCLK/8, IOCLK/32, IOCLK/128, TM28IO pin input,

Timer 26 underflow, Timer 27 underflow

Timer 29 (8-bit timer)

Functions:

Interval timer, Timer pulse output, Event count, Cascade connection

Count clock source:

IOCLK, IOCLK/8, IOCLK/32, IOCLK/128, TM29IO pin input,

Timer 26 underflow, Timer 27 underflow, Timer 28 underflow

Timer 16 (16-bit timer)

Functions:

Interval timer, Event count, Up/down count, Timer output,

PWM output, Input capture, one-shot output, Start trigger,

A/D conversion start trigger generation

Count clock source:

MCLK, MCLK/2, IOCLK, IOCLK/8,

Timer 6 underflow, Timer 7 underflow, TM16BIO pin input

Timer 17 (16-bit timer)

Functions:

Interval timer, Event count, Up/down count, Timer output,

PWM output, Input capture, one-shot output, Start trigger,

A/D conversion start trigger generation

Count clock source:

MCLK, MCLK/2, IOCLK, IOCLK/8,

Timer 4 underflow, Timer 5 underflow, TM17BIO pin input

Timer 18 (16-bit timer)

Functions:

Interval timer, Event count, Up/down count, Timer output,
PWM output, Input capture, one-shot output, Start trigger,
A/D conversion start trigger generation

Count clock source:

MCLK, MCLK/2, IOCLK, IOCLK/8,
Timer 6 underflow, Timer 7 underflow, TM18BIO pin input

Timer 19 (16-bit timer)

Functions:

Interval timer, Event count, Up/down count, Timer output,
PWM output, Input capture, one-shot output, Start trigger,
A/D conversion start trigger generation

Count clock source:

MCLK, MCLK/2, IOCLK, IOCLK/8,
Timer 4 underflow, Timer 5 underflow, TM19BIO pin input

Timer 20 (16-bit timer)

Functions:

Interval timer, Event count, Up/down count, Timer output,
PWM output, Input capture, one-shot output, Start trigger,
A/D conversion start trigger generation

Count clock source:

IOCLK, IOCLK/8, IOCLK/32, IOCLK/64,
Timer 10 underflow, Timer 11 underflow, TM20BIO pin input

Timer 21 (16-bit timer)

Functions:

Interval timer, Event count, Up/down count, Timer output,
PWM output, Input capture, one-shot output, Start trigger,
A/D conversion start trigger generation

Count clock source:

IOCLK, IOCLK/8, IOCLK/32, IOCLK/64,
Timer 8 underflow, Timer 9 underflow, TM21BIO pin input

Timer 22 (16-bit timer)

Functions:

Interval timer, Event count, Up/down count, Timer output,
PWM output, Input capture, one-shot output, Start trigger,
A/D conversion start trigger generation

Count clock source:

IOCLK, IOCLK/8, IOCLK/32, IOCLK/64,
Timer 10 underflow, Timer 11 underflow, TM22BIO pin input

Timer 23 (16-bit timer)

Functions:

Interval timer, Event count, Up/down count, Timer output,
PWM output, Input capture, one-shot output, Start trigger,
A/D conversion start trigger generation

Count clock source:

IOCLK, IOCLK/8, IOCLK/32, IOCLK/64,
Timer 8 underflow, Timer 9 underflow, TM23BIO pin input

Timer 24 (16-bit timer)

Functions:

Interval timer, Event count, Up/down count, Timer output,
PWM output, Input capture, one-shot output, Start trigger,
A/D conversion start trigger generation

Count clock source:

MCLK, MCLK/2, IOCLK, IOCLK/8,
Timer 28 underflow, Timer 29 underflow, TM24BIO pin input

■ Watchdog Timer

Count clock External high-speed oscillation
Detection time External high-speed oscillation cycle $\times 2^{16}$ to 2^{24}
Generates non-maskable interrupt at detection
Generates hard-reset at second consecutive overflow

■ Watchdog Timer 2

Count clock Internal low-speed oscillation
Detection time Internal low-speed oscillation cycle $\times 2^7$ to 2^{18}
Generates non-maskable interrupt at detection
Generates hard-reset at second consecutive overflow

■ A /D Converter

A/D0

-Resolution: 12 bit
-Minimum conversion time 0.6 μ s
-A/D conversion start trigger is in synchronization with complementary 3-phase PWM cycle
and 16-bit timer

A/D1

-Resolution: 12 bit
-Minimum conversion time 0.6 μ s
-A/D conversion start trigger is in synchronization with complementary 3-phase PWM cycle
and 16-bit timer

A/D2

-Resolution: 10 bit
-Minimum conversion time 0.5 μ s
-A/D conversion start trigger is in synchronization with complementary 3-phase PWM cycle
and 16-bit timer

■ Analog Circuits

VGA (Variable gain amplifier)

-Unit: 3 units (max)
-Gain 2, 3, 4, 5, 6, 8, 10, 20 times
-Channel 12 (ADIN00 to ADIN03, ADIN08 to ADIN11, ADIN16 to ADIN19)
--Input can switch 1-phase/3-phase (VGAnP0/1/2)
--Input is common (VGAnN)

Comparator

- Unit: 3 units (max)
- Reference voltage: Pin input(CMPnREF), output of D/A converter
- Input from VGA output
- Pin output(CMPOUTn) of comparator output

D/A converter

- Unit: 3 units (max)
- Resolution: 10 bit
- Generates reference voltage

■ Complementary 3-phase PWM output

- Min. resolution: 8.33 ns
- Triangular and saw-tooth waves output
- Incorporates a dead time insertion circuit
- Can overwrite registers by double buffer during PWM operation
- PWM output protection circuit supporting external interrupts and non-maskable interrupt
- Output timing varying function
- A/D conversion start trigger, 16-bit timer start trigger output

■ CAN Controller

Channels: 1 channel

CAN 2.0B specification basis

- Communication method: NRZ (Non-Return to Zero)
- Transmission line: Interactive 2-wire serial communication
- Communication speed: Max 1 Mbps
- Data length: 0 to 8 byte
- Message frame: Standard frame and extended frame are supported
(Standard frame format ID: 11 bits,
Extended frame format ID: 29 bits)

Buffer size: 32 messages (32 × 132 bit)

Interrupt: 1 interrupt

Interrupt requests:

- Bus-off state, error active state
- Error alert state (When the error counter is over 96.)
- Release the error alert state (When the error counter is under 96.)
- Transmission/Reception end
- Transmission/Reception error (Ack/Form/Stuff/ Bit1/ Bit0/CRC error)

■ Serial Interface

Serial 0 (Synchronous serial interface / Full duplex UART / Multi master IIC)

Synchronous serial interface

- Overrun error detection
- Transfer clock source
 - 1/2, 1/4, 1/16 and 1/64 of timer 0 underflow,
 - 1/2, 1/4, 1/16 and 1/64 of timer 1 underflow,
 - 1/2, 1/4, 1/16 and 1/64 of timer 2 underflow,
 - 1/2, 1/4, 1/16 and 1/64 of timer 3 underflow,
 - IOCLK/2, IOCLK/4, SBT0 pin
- Transfer clock division value selection: Divided by 8, 16
- Can be selected as the first bit to be transferred,
Any transfer size from 2 to 8 bits can be selected.
- Can be continuously transmitted, received or transmitted and received.
- Maximum transfer rate: 5.0 Mbps

Full duplex UART

- Parity check, Overrun and framing error detection
- Transfer clock source
 - 1/2, 1/4, 1/16, and 1/64 of timer 0 underflow,
 - 1/2, 1/4, 1/16, and 1/64 of timer 1 underflow,
 - 1/2, 1/4, 1/16, and 1/64 of timer 2 underflow,
 - 1/2, 1/4, 1/16, and 1/64 of timer 3 underflow,
 - IOCLK/2, IOCLK/4
- Transfer clock division value selection: Divided by 8, 16
- Can be selected as the first bit to be transferred,
Any transfer size from 7 to 8 bits can be selected.
- Continuous transmission, reception, and transmission/reception
- Maximum transfer rate: 300 kbps

Multi master IIC

- Transfer clock source
 - 1/2, 1/4, 1/16, and 1/32 of timer 0 underflow,
 - 1/2, 1/4, 1/16, and 1/32 of timer 1 underflow,
 - 1/2, 1/4, 1/16, and 1/32 of timer 2 underflow,
 - 1/2, 1/4, 1/16, and 1/32 of timer 3 underflow,
 - IOCLK/2, IOCLK/4
- Transfer clock division value selection: Divided by 8

Serial 1 (Synchronous serial interface / Full duplex UART / LIN)

Synchronous serial interface

- Overrun error detection
- Transfer clock source
 - 1/2, 1/4, 1/16 and 1/64 of timer 0 underflow,
 - 1/2, 1/4, 1/16 and 1/64 of timer 1 underflow,
 - 1/2, 1/4, 1/16 and 1/64 of timer 2 underflow,
 - 1/2, 1/4, 1/16 and 1/64 of timer 3 underflow,
 - IOCLK/2, IOCLK/4, SBT1 pin
- Transfer clock division value selection: No, Divided by 8, 16
- Can be selected as the first bit to be transferred,
Any transfer size from 2 to 8 bits can be selected.
- Can be continuously transmitted, received or transmitted and received.
- Maximum transfer rate: 5.0 Mbps

Full duplex UART

- Parity check, Overrun and framing error detection
- Transfer clock source
 - 1/2, 1/4, 1/16, and 1/64 of timer 0 underflow,

1/2, 1/4, 1/16, and 1/64 of timer 1 underflow,

1/2, 1/4, 1/16, and 1/64 of timer 2 underflow,

1/2, 1/4, 1/16, and 1/64 of timer 3 underflow,

IOCLK/2, IOCLK/4

- Transfer clock division value selection: Divided by 8, 16
- Can be selected as the first bit to be transferred,
Any transfer size from 7 to 8 bits can be selected.
- Continuous transmission, reception, and transmission/reception
- Maximum transfer rate: 300 kbps

LIN

- Operate in conjunction with Timer 6 and 19.
- Master communication
Synch Break field transmission
- Slave communication
Wake-up reception, Synch Break field reception, Synch field reception,
Check sum arithmetic
- Error detection
Check sum error, bit error

Serial 2 (Synchronous serial interface / Full duplex UART)

Synchronous serial interface

- Overrun error detection
- Transfer clock source
1/2, 1/4, 1/16 and 1/64 of timer 0 underflow,
1/2, 1/4, 1/16 and 1/64 of timer 1 underflow,
1/2, 1/4, 1/16 and 1/64 of timer 2 underflow,
1/2, 1/4, 1/16 and 1/64 of timer 3 underflow,
IOCLK/2, IOCLK/4, SBT2 pin
- Transfer clock division value selection: No, Divided by 8, 16
- Can be selected as the first bit to be transferred,
Any transfer size from 2 to 8 bits can be selected.
- Can be continuously transmitted, received or transmitted and received.
- Maximum transfer rate: 5.0 Mbps

Full duplex UART

- Parity check, Overrun and framing error detection
- Transfer clock source
1/2, 1/4, 1/16, and 1/64 of timer 0 underflow,
1/2, 1/4, 1/16, and 1/64 of timer 1 underflow,
1/2, 1/4, 1/16, and 1/64 of timer 2 underflow,
1/2, 1/4, 1/16, and 1/64 of timer 3 underflow,
IOCLK/2, IOCLK/4
- Transfer clock division value selection: Divided by 8, 16
- Can be selected as the first bit to be transferred,
Any transfer size from 7 to 8 bits can be selected.
- Continuous transmission, reception, and transmission/reception
- Maximum transfer rate: 300 kbps

Serial 3 (Synchronous serial interface / Full duplex UART)

Synchronous serial interface

- Overrun error detection
- Transfer clock source
 - 1/2, 1/4, 1/16 and 1/64 of timer 0 underflow,
 - 1/2, 1/4, 1/16 and 1/64 of timer 1 underflow,
 - 1/2, 1/4, 1/16 and 1/64 of timer 2 underflow,
 - 1/2, 1/4, 1/16 and 1/64 of timer 3 underflow,
 - IOCLK/2, IOCLK/4, SBT3 pin
- Transfer clock division value selection: No, Divided by 8, 16
- Can be selected as the first bit to be transferred,
Any transfer size from 2 to 8 bits can be selected.
- Can be continuously transmitted, received or transmitted and received.
- Maximum transfer rate: 5.0 Mbps

Full duplex UART

- Parity check, Overrun and framing error detection
- Transfer clock source
 - 1/2, 1/4, 1/16, and 1/64 of timer 0 underflow,
 - 1/2, 1/4, 1/16, and 1/64 of timer 1 underflow,
 - 1/2, 1/4, 1/16, and 1/64 of timer 2 underflow,
 - 1/2, 1/4, 1/16, and 1/64 of timer 3 underflow,
 - IOCLK/2, IOCLK/4
- Transfer clock division value selection: Divided by 8, 16
- Can be selected as the first bit to be transferred,
Any transfer size from 7 to 8 bits can be selected.
- Continuous transmission, reception, and transmission/reception
- Maximum transfer rate: 300 kbps

Serial 4 (Synchronous serial interface / Full duplex UART)

Synchronous serial interface

- Overrun error detection
- Transfer clock source
 - 1/2, 1/4, 1/16 and 1/64 of timer 26 underflow,
 - 1/2, 1/4, 1/16 and 1/64 of timer 27 underflow,
 - 1/2, 1/4, 1/16 and 1/64 of timer 28 underflow,
 - 1/2, 1/4, 1/16 and 1/64 of timer 29 underflow,
 - IOCLK/2, IOCLK/4, SBT4 pin
- Transfer clock division value selection: No, Divided by 8, 16
- Can be selected as the first bit to be transferred,
Any transfer size from 2 to 8 bits can be selected.
- Can be continuously transmitted, received or transmitted and received.
- Maximum transfer rate: 5.0 Mbps

Full duplex UART

- Parity check, Overrun and framing error detection
- Transfer clock source
 - 1/2, 1/4, 1/16, and 1/64 of timer 26 underflow,
 - 1/2, 1/4, 1/16, and 1/64 of timer 27 underflow,
 - 1/2, 1/4, 1/16, and 1/64 of timer 28 underflow,
 - 1/2, 1/4, 1/16, and 1/64 of timer 29 underflow,
 - IOCLK/2, IOCLK/4
- Transfer clock division value selection: Divided by 8, 16
- Can be selected as the first bit to be transferred,
Any transfer size from 7 to 8 bits can be selected.
- Continuous transmission, reception, and transmission/reception
- Maximum transfer rate: 300 kbps

■ Power Supply Voltage Detection

Detection level Can select 3 phase;

4.15 V \pm 0.25 V (At falling voltage) 4.25 V \pm 0.25 V (At rising voltage)

3.70 V \pm 0.20 V (At falling voltage) 3.80 V \pm 0.20 V (At rising voltage)

2.80 V \pm 0.20 V (At falling voltage) 2.90 V \pm 0.20 V (At rising voltage)

When power supply voltage become equal to detection level, interrupt or reset is generated.

■ Auto Reset Circuit

Detection level 2.70 V \pm 0.30 V (At falling voltage)

2.45 V \pm 0.15 V (At rising voltage)

When power supply voltage is under detection level, reset is generated.

■ Clock Monitoring Function

Frequency error of the external high-speed oscillation (include PLL output) can detect.

When the error is detected, reset is generated.

■ Package

144 pin LQFP(20 mm square, 0.5 mm pitch, halogen free)

128 pin LQFP(18 mm square, 0.5 mm pitch, halogen free)

100 pin LQFP(14 mm square, 0.5 mm pitch, halogen free)

80 pin TQFP(12 mm square, 0.5 mm pitch, halogen free)

64 pin TQFP(10 mm square, 0.5 mm pitch, halogen free)

Panasonic "halogen free" semiconductor products refer to the products made of molding resin and interposer which conform to the following standards.

- Bromine : 900 ppm (Maximum Concentration Value)

- Chlorine : 900 ppm (Maximum Concentration Value)

- Bromine + Chlorine : 1500 ppm (Maximum Concentration Value)

The above-mentioned standards are based on the numerical value described in IEC61249-2-21.

Antimony and its compounds are not added intentionally.

1.4 Pin Configuration

1.4.1 Pin Configuration

■ MN103HF48/58 Series

Figure:1.4.1 shows the pin configuration of MN103HF48/58 series.

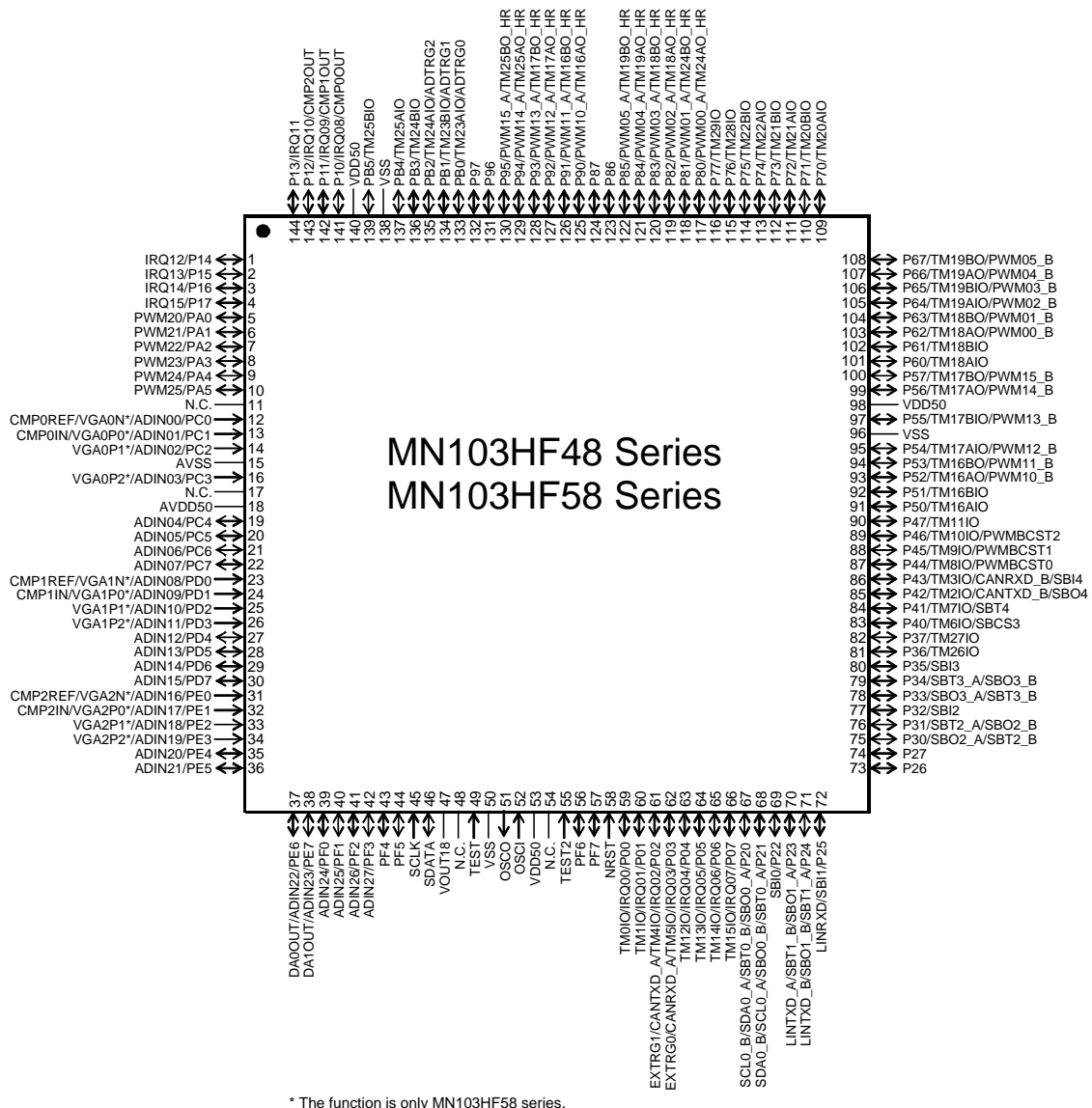

Figure:1.4.1 Pin Configuration of MN103HF48/58 Series



■ MN103HF47/57 Series

Figure:1.4.2 shows the pin configuration of MN103HF47/57 series.

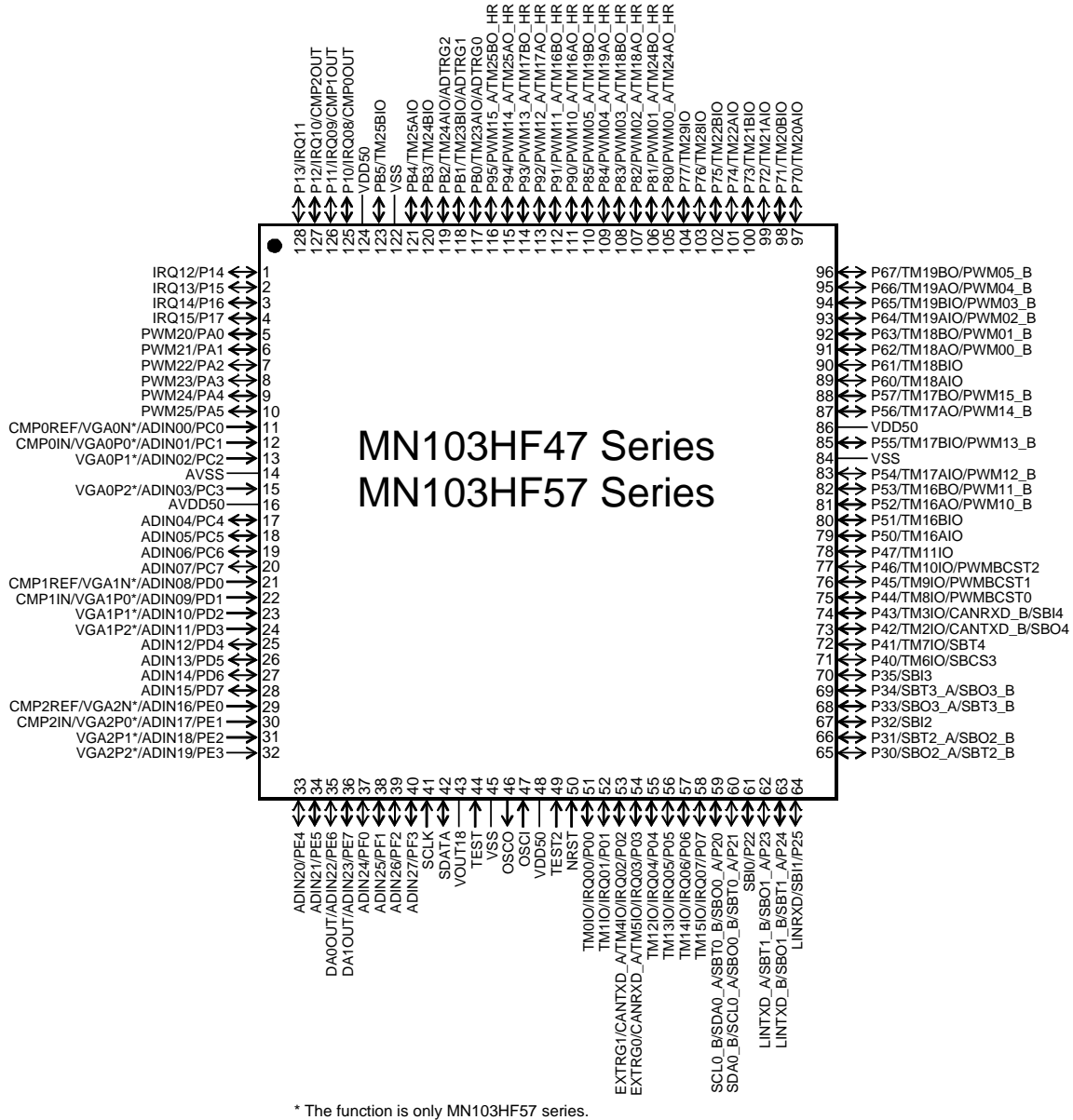

Figure:1.4.2 Pin Configuration of MN103HF47/57 Series

■ MN103HF46/56 Series

Figure:1.4.3 shows the pin configuration of MN103HF46/56 series.

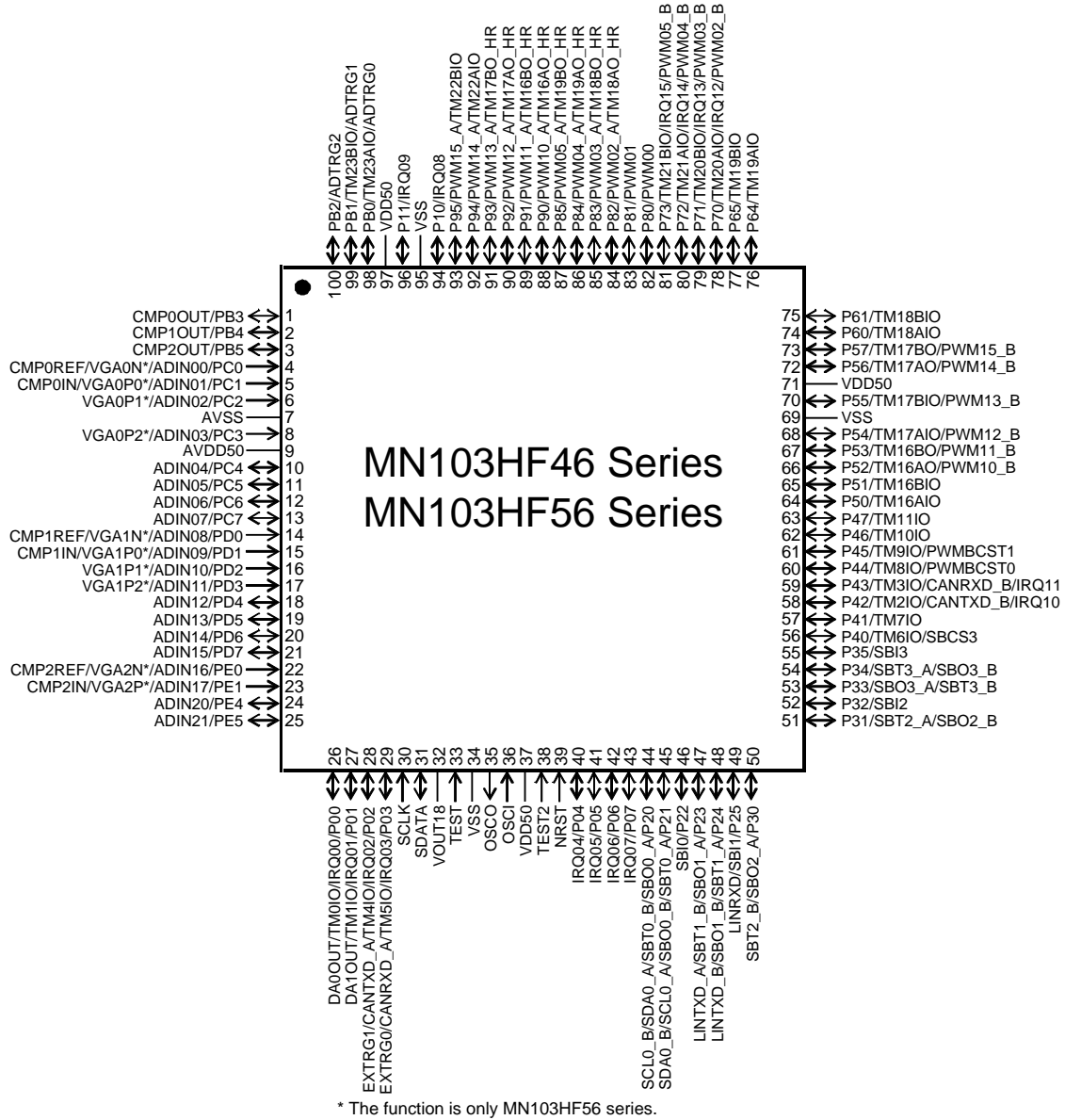

Figure:1.4.3 Pin Configuration of MN103HF46/56 Series

■ MN103HF45/55 Series

Figure:1.4.4 shows the pin configuration of MN103HF45/55 series.

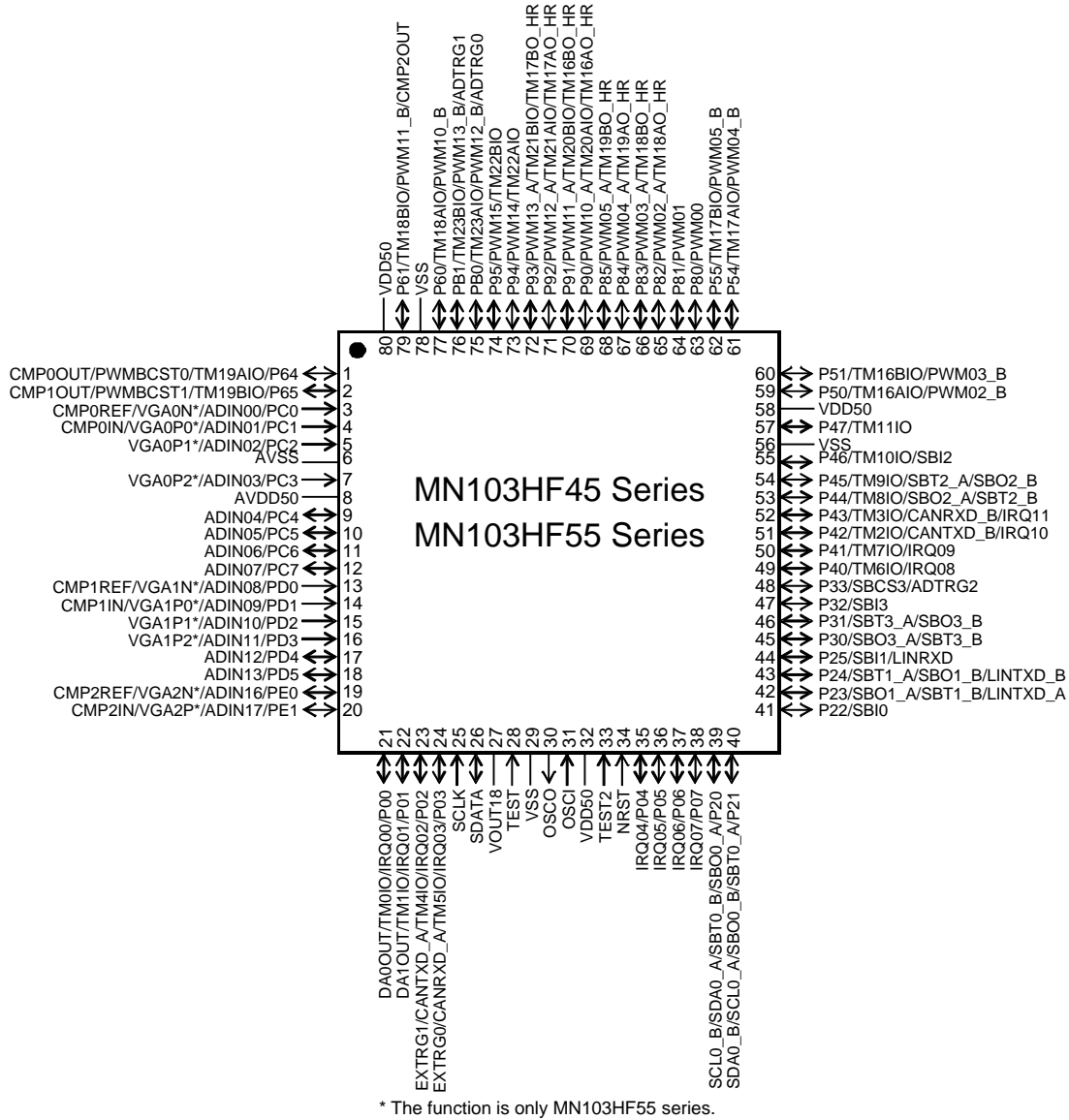

Figure:1.4.4 Pin Configuration of MN103HF45/55 Series

■ MN103HF44/54 Series

Figure:1.4.5 shows the pin configuration of MN103HF44/54 series.

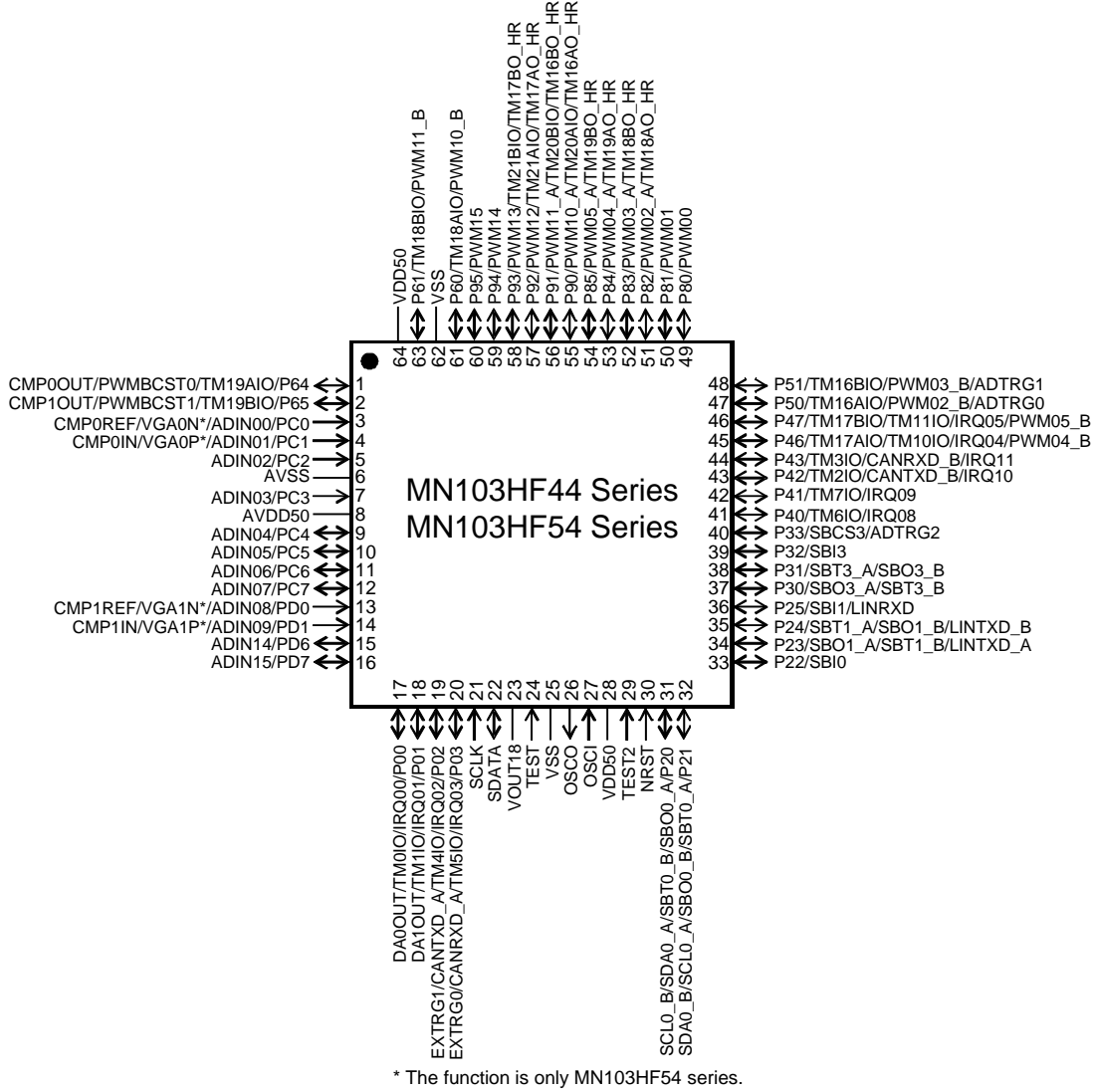

Figure:1.4.5 Pin Configuration of MN103HF44/54 Series

1.5 Pin Functions

1.5.1 Pin Functions (MN103HFx8)

The function of each pin is listed in Table:1.5.1.

Table:1.5.1 Pin Functions of MN103HFx8

	Pins	Other Pins				Function
Power supply/GND	VDD50					Power pin for digital IO Connect 1 μ F capacitor or more between all of the VDD50 and VSS pins. (Put the capacitor near the pins.)
	AVDD50					Power pin for analog Connect 1 μ F capacitor or more between AVDD50 and AVSS pins. (Put the capacitor near the pins.)
	VOUT18					Internal power pin Connect 1 μ F capacitors between VOUT18 and VSS pins. (Put the capacitor near the pins.)
	AVSS					GND for analog
	VSS					GND for digital
Function control	TEST					Test signal input pin Add the pull-up resistor of 2 k Ω or more. (Put the resistor near the pins.)
	TEST2					Add the pull-up resistor of 2 k Ω or more. (Put the resistor near the pins.)
Reset	NRST					Reset pins (negative logic) Connect 0.1 μ F capacitor or more between NRST and VSS pins.
Clock	OSCI					High-speed oscillation input pin
	OSCO					High-speed oscillation output pin
Interrupt	IRQ00	P00	TM0IO			External interrupt input pin
	IRQ01	P01	TM1IO			
	IRQ02	P02	TM4IO	CANTXD_A	EXTRG1	
	IRQ03	P03	TM5IO	CANRXD_A	EXTRG0	
	IRQ04	P04	TM12IO			
	IRQ05	P05	TM13IO			
	IRQ06	P06	TM14IO			
	IRQ07	P07	TM15IO			

	Pins	Other Pins				Function
Interrupt	IRQ08	P10	CMP0OUT			External interrupt input pin
	IRQ09	P11	CMP1OUT			
	IRQ10	P12	CMP2OUT			
	IRQ11	P13				
	IRQ12	P14				
	IRQ13	P15				
	IRQ14	P16				
	IRQ15	P17				
Timer	TM0IO	P00	IRQ00			8-bit timer I/O pin
	TM1IO	P01	IRQ01			
	TM2IO	P42	CANTXD_B	SBO4		
	TM3IO	P43	CANRXD_B	SBI4		
	TM4IO	P02	IRQ02	CANTXD_A	EXTRG1	
	TM5IO	P03	IRQ03	CANRXD_A	EXTRG0	
	TM6IO	P40	SBCS3			
	TM7IO	P41	SBT4			
	TM8IO	P44	PWMBCST0			
	TM9IO	P45	PWMBCST1			
	TM10IO	P46	PWMBCST2			
	TM11IO	P47				
	TM12IO	P04	IRQ04			
	TM13IO	P05	IRQ05			
	TM14IO	P06	IRQ06			
	TM15IO	P07	IRQ07			
	TM26IO	P36				
	TM27IO	P37				
	TM28IO	P76				
	TM29IO	P77				
	TM16AIO	P50				16-bit timer I/O A, B pin
	TM16BIO	P51				
	TM17AIO	P54	PWM12_B			
	TM17BIO	P55	PWM13_B			
TM18AIO	P60					
TM18BIO	P61					
TM19AIO	P64	PWM02_B				
TM19BIO	P65	PWM03_B				
TM20AIO	P70					
TM20BIO	P71					

	Pins	Other Pins			Function
Timer	TM21AIO	P72			16-bit timer I/O A, B pin
	TM21BIO	P73			
	TM22AIO	P74			
	TM22BIO	P75			
	TM23AIO	PB0	ADTRG0		
	TM23BIO	PB1	ADTRG1		
	TM24AIO	PB2	ADTRG2		
	TM24BIO	PB3			
	TM25AIO	PB4			
	TM25BIO	PB5			
	TM16AO	P52	PWM10_B		16-bit timer Output A, B pin
	TM16BO	P53	PWM11_B		
	TM17AO	P56	PWM14_B		
	TM17BO	P57	PWM15_B		
	TM18AO	P62	PWM00_B		
	TM18BO	P63	PWM01_B		
	TM19AO	P66	PWM04_B		
	TM19BO	P67	PWM05_B		
	TM16AO_HR	P90	PWM10_A		
	TM16BO_HR	P91	PWM11_A		
TM17AO_HR	P92	PWM12_A			
TM17BO_HR	P93	PWM13_A			
TM18AO_HR	P82	PWM02_A			
TM18BO_HR	P83	PWM03_A			
TM19AO_HR	P84	PWM04_A			
TM19BO_HR	P85	PWM05_A			
TM24AO_HR	P80	PWM00_A			
TM24BO_HR	P81	PWM01_A			
TM25AO_HR	P94	PWM14_A			
TM25BO_HR	P95	PWM15_A			
PWM	PWM00_A	P80	TM24AO_HR		Motor control 3-phase PWM signal output pin
	PWM01_A	P81	TM24BO_HR		
	PWM02_A	P82	TM18AO_HR		
	PWM03_A	P83	TM18BO_HR		
	PWM04_A	P84	TM19AO_HR		
	PWM05_A	P85	TM19BO_HR		
	PWM10_A	P90	TM16AO_HR		
	PWM11_A	P91	TM16BO_HR		

	Pins	Other Pins				Function
PWM	PWM12_A	P92	TM17AO_HR			Motor control 3-phase PWM signal output pin
	PWM13_A	P93	TM17BO_HR			
	PWM14_A	P94	TM25AO_HR			
	PWM15_A	P95	TM25BO_HR			
	PWM00_B	P62	TM18AO			
	PWM01_B	P63	TM18BO			
	PWM02_B	P64	TM19AIO			
	PWM03_B	P65	TM19BIO			
	PWM04_B	P66	TM19AO			
	PWM05_B	P67	TM19BO			
	PWM10_B	P52	TM16AO			
	PWM11_B	P53	TM16BO			
	PWM12_B	P54	TM17AIO			
	PWM13_B	P55	TM17BIO			
	PWM14_B	P56	TM17AO			
	PWM15_B	P57	TM17BO			
	PWM20	PA0				
	PWM21	PA1				
	PWM22	PA2				
	PWM23	PA3				
PWM24	PA4					
PWM25	PA5					
PWMBBCST0	P44	TM8IO			Motor control 3-phase PWM counter state monitor pin	
PWMBBCST1	P45	TM9IO				
PWMBBCST2	P46	TM10IO				
Serial	SBT0_A	P21	SBO0_B	SCL0_A	SDA0_B	Serial interface clock I/O pin
	SBT0_B	P20	SBO0_A	SDA0_A	SCL0_B	
	SBT1_A	P24	SBO1_B	LINTXD_B		
	SBT1_B	P23	SBO1_A	LINTXD_A		
	SBT2_A	P31	SBO2_B			
	SBT2_B	P30	SBO2_A			
	SBT3_A	P34	SBO3_B			
	SBT3_B	P33	SBO3_A			
	SBT4	P41	TM7IO			
	SBO0_A	P20	SBT0_B	SDA0_A	SCL0_B	
	SBO0_B	P21	SBT0_A	SCL0_A	SDA0_B	
	SBO1_A	P23	SBT1_B	LINTXD_A		
	SBO1_B	P24	SBT1_A	LINTXD_B		

	Pins	Other Pins				Function
Serial	SBO2_A	P30	SBT2_B			Serial interface data output pin
	SBO2_B	P31	SBT2_A			
	SBO3_A	P33	SBT3_B			
	SBO3_B	P34	SBT3_A			
	SBO4	P42	TM2IO	CANTXD_B		
	SBI0	P22				Serial interface data input pin
	SBI1	P25	LINRXD			
	SBI2	P32				
	SBI3	P35				
	SBI4	P43	TM3IO	CANRXD_B		
	SBCS3	P40	TM6IO			Serial chip select I/O pin
IIC	SCL0_A	P21	SBT0_A	SBO0_B	SDA0_B	IIC clock I/O pin
	SCL0_B	P20	SBO0_A	SBT0_B	SDA0_A	
	SDA0_A	P20	SBO0_A	SBT0_B	SCL0_B	IIC communication I/O pin
	SDA0_B	P21	SBT0_A	SBO0_B	SCL0_A	
CAN	CANTXD_A	P02	IRQ02	TM4IO	EXTRG1	CAN communication output pin
	CANTXD_B	P42	TM2IO	SBO4		
	CANRXD_A	P03	IRQ03	TM5IO	EXTRG0	CAN communication input pin
	CANRXD_B	P43	TM3IO	SBI4		
LIN	LINTXD_A	P23	SBO1_A	SBT1_B		LIN communication output pin
	LINTXD_B	P24	SBT1_A	SBO1_B		
	LINRXD	P25	SBI1			LIN communication input pin
A/D converter	ADIN00	PC0	VGA0N	CMP0REF		Analog input pin for A/D converters
	ADIN01	PC1	VGA0P0	CMP0IN		
	ADIN02	PC2	VGA0P1			
	ADIN03	PC3	VGA0P2			
	ADIN04	PC4				
	ADIN05	PC5				
	ADIN06	PC6				
	ADIN07	PC7				
	ADIN08	PD0	VGA1N	CMP1REF		
	ADIN09	PD1	VGA1P0	CMP1IN		
	ADIN10	PD2	VGA1P1			
	ADIN11	PD3	VGA1P2			
	ADIN12	PD4				
	ADIN13	PD5				
	ADIN14	PD6				
	ADIN15	PD7				
	ADIN16	PE0	VGA2N	CMP2REF		
	ADIN17	PE1	VGA2P0	CMP2IN		
ADIN18	PE2	VGA2P1				

	Pins	Other Pins				Function
A/D converter	ADIN19	PE3	VGA2P2			Analog input pin for A/D converters
	ADIN20	PE4				
	ADIN21	PE5				
	ADIN22	PE6	DA0OUT			
	ADIN23	PE7	DA1OUT			
	ADIN24	PF0				
	ADIN25	PF1				
	ADIN26	PF2				
	ADIN27	PF3				
	ADTRG0	PB0	TM23AIO			A/D conversion trigger output pin
	ADTRG1	PB1	TM23BIO			
	ADTRG2	PB2	TM24AIO			
VGA(*1)	VGA0N	PC0	ADIN00	CMP0REF		Analog input pin for VGA
	VGA0P0	PC1	ADIN01	CMP0IN		
	VGA0P1	PC2	ADIN02			
	VGA0P2	PC3	ADIN03			
	VGA1N	PD0	ADIN08	CMP1REF		
	VGA1P0	PD1	ADIN09	CMP1IN		
	VGA1P1	PD2	ADIN10			
	VGA1P2	PD3	ADIN11			
	VGA2N	PE0	ADIN16	CMP2REF		
	VGA2P0	PE1	ADIN17	CMP2IN		
	VGA2P1	PE2	ADIN18			
	VGA2P2	PE3	ADIN19			
Comparator	CMP0REF	PC0	ADIN00	VGA0N		Power supply pin for comparator
	CMP1REF	PD0	ADIN08	VGA1N		
	CMP2REF	PE0	ADIN16	VGA2N		
	CMP0IN	PC1	ADIN01	VGA0P0		Input pin for comparator
	CMP1IN	PD1	ADIN09	VGA1P0		
	CMP2IN	PE1	ADIN17	VGA2P0		
	CMP0OUT	P10	IRQ08			Output pin for comparator
	CMP1OUT	P11	IRQ09			
	CMP2OUT	P12	IRQ10			
D/A converter	DA0OUT	PE6	ADIN22			Output pin for D/A converter
	DA1OUT	PE7	ADIN23			
I/O port	P00	IRQ00	TM0IO			I/O port 0
	P01	IRQ01	TM1IO			
	P02	IRQ02	TM4IO	CANTXD_A	EXTRG1	
	P03	IRQ03	TM5IO	CANRXD_A	EXTRG0	

	Pins	Other Pins				Function
I/O port	P04	IRQ04	TM12IO			I/O port 0
	P05	IRQ05	TM13IO			
	P06	IRQ06	TM14IO			
	P07	IRQ07	TM15IO			
	P10	IRQ08	CMP0OUT			I/O port 1
	P11	IRQ09	CMP1OUT			
	P12	IRQ10	CMP2OUT			
	P13	IRQ11				
	P14	IRQ12				
	P15	IRQ13				
	P16	IRQ14				
	P17	IRQ15				
	P20	SBO0_A	SBT0_B	SDA0_A	SCL0_B	I/O port 2
	P21	SBT0_A	SBO0_B	SCL0_A	SDA0_B	
	P22	SBI0				
	P23	SBO1_A	SBT1_B	LINTXD_A		
	P24	SBT1_A	SBO1_B	LINTXD_B		
	P25	SBI1	LINRXD			
	P26					
	P27					
	P30	SBO2_A	SBT2_B			I/O port 3
	P31	SBT2_A	SBO2_B			
	P32	SBI2				
	P33	SBO3_A	SBT3_B			
	P34	SBT3_A	SBO3_B			
	P35	SBI3				
	P36	TM26IO				
	P37	TM27IO				
	P40	TM6IO	SBCS3			I/O port 4
	P41	TM7IO	SBT4			
	P42	TM2IO	CANTXD_B	SBO4		
P43	TM3IO	CANRXD_B	SBI4			
P44	TM8IO	PWMBCST0				
P45	TM9IO	PWMBCST1				
P46	TM10IO	PWMBCST2				
P47	TM11IO					
P50	TM16AIO				I/O port 5	
P51	TM16BIO					

	Pins	Other Pins			Function
I/O port	P52	TM16AO	PWM10_B		I/O port 5
	P53	TM16BO	PWM11_B		
	P54	TM17AIO	PWM12_B		
	P55	TM17BIO	PWM13_B		
	P56	TM17AO	PWM14_B		
	P57	TM17BO	PWM15_B		
	P60	TM18AIO			I/O port 6
	P61	TM18BIO			
	P62	TM18AO	PWM00_B		
	P63	TM18BO	PWM01_B		
	P64	TM19AIO	PWM02_B		
	P65	TM19BIO	PWM03_B		
	P66	TM19AO	PWM04_B		
	P67	TM19BO	PWM05_B		
	P70	TM20AIO			I/O port 7
	P71	TM20BIO			
	P72	TM21AIO			
	P73	TM21BIO			
	P74	TM22AIO			
P75	TM22BIO				
P76	TM28IO				
P77	TM29IO				
P80	PWM00_A	TM24AO_HR		I/O port 8	
P81	PWM01_A	TM24BO_HR			
P82	PWM02_A	TM18AO_HR			
P83	PWM03_A	TM18BO_HR			
P84	PWM04_A	TM19AO_HR			
P85	PWM05_A	TM19BO_HR			
P86					
P87					
P90	PWM10_A	TM16AO_HR		I/O port 9	
P91	PWM11_A	TM16BO_HR			
P92	PWM12_A	TM17AO_HR			
P93	PWM13_A	TM17BO_HR			
P94	PWM14_A	TM25AO_HR			
P95	PWM15_A	TM25BO_HR			
P96					
P97					

	Pins	Other Pins			Function	
I/O port	PA0	PWM20			I/O port A	
	PA1	PWM21				
	PA2	PWM22				
	PA3	PWM23				
	PA4	PWM24				
	PA5	PWM25				
	PB0	TM23AIO	ADTRG0			I/O port B
	PB1	TM23BIO	ADTRG1			
	PB2	TM24AIO	ADTRG2			
	PB3	TM24BIO				
	PB4	TM25AIO				
	PB5	TM25BIO				
	PC0	ADIN00	VGA0N	CMP0REF		Input(/Output) port C
	PC1	ADIN01	VGA0P0	CMP0IN		
	PC2	ADIN02	VGA0P1			
	PC3	ADIN03	VGA0P2			
	PC4	ADIN04				
	PC5	ADIN05				
	PC6	ADIN06				
	PC7	ADIN07				
	PD0	ADIN08	VGA1N	CMP1REF		Input(/Output) port D
	PD1	ADIN09	VGA1P0	CMP1IN		
	PD2	ADIN10	VGA1P1			
	PD3	ADIN11	VGA1P2			
	PD4	ADIN12				
PD5	ADIN13					
PD6	ADIN14					
PD7	ADIN15					
PE0	ADIN16	VGA2N	CMP2REF		Input(/Output) port E	
PE1	ADIN17	VGA2P0	CMP2IN			
PE2	ADIN18	VGA2P1				
PE3	ADIN19	VGA2P2				
PE4	ADIN20					
PE5	ADIN21					
PE6	ADIN22	DA0OUT				
PE7	ADIN23	DA1OUT				
PF0	ADIN24				I/O port F	
PF1	ADIN25					

	Pins	Other Pins				Function
I/O port	PF2	ADIN26				I/O port F
	PF3	ADIN27				
	PF4					
	PF5					
	PF6					
	PF7					
OBD	SCLK					On-board debugger clock input pin Connect the pull-up resistor of 10 k Ω or more.
	SDATA					On-board debugger data I/O pin Connect the pull-up resistor of 10 k Ω or more.
	EXTRG0	P03	TM5IO	IRQ03	CANRXD_A	On-board debugger trigger I/O pin
	EXTRG1	P02	TM4IO	IRQ02	CANTXD_A	



*1 VGA is not in MN103HF48 series.

1.5.2 Pin Functions (MN103HFx7)

The function of each pin is listed in Table:1.5.2.

Table:1.5.2 Pin Functions of MN103HFx7

	Pins	Other Pins				Function
Power supply/GND	VDD50					Power pin for digital IO Connect 1 μ F capacitor or more between all of the VDD50 and VSS pins. (Put the capacitor near the pins.)
	AVDD50					Power pin for analog Connect 1 μ F capacitor or more between AVDD50 and AVSS pins. (Put the capacitor near the pins.)
	VOOUT18					Internal power pin Capacitors between VOOUT18 and VSS pins. (Put the capacitor near the pins.)
	AVSS					GND for analog
	VSS					GND for digital
Function control	TEST					Test signal input pin Add the pull-up resistor of 2 k Ω or more. (Put the resistor near the pins.)
	TEST2					Add the pull-up resistor of 2 k Ω or more. (Put the resistor near the pins.)
Reset	NRST					Reset pins (negative logic) Connect 0.1 μ F capacitor or more between NRST and VSS pins.
Clock	OSCI					High-speed oscillation input pin
	OSCO					High-speed oscillation output pin
Interrupt	IRQ00	P00	TM0IO			External interrupt input pin
	IRQ01	P01	TM1IO			
	IRQ02	P02	TM4IO	CANTXD_A	EXTRG1	
	IRQ03	P03	TM5IO	CANRXD_A	EXTRG0	
	IRQ04	P04	TM12IO			
	IRQ05	P05	TM13IO			
	IRQ06	P06	TM14IO			
	IRQ07	P07	TM15IO			
	IRQ08	P10	CMP0OUT			
	IRQ09	P11	CMP1OUT			
	IRQ10	P12	CMP2OUT			
	IRQ11	P13				
	IRQ12	P14				
	IRQ13	P15				
	IRQ14	P16				
IRQ15	P17					

	Pins	Other Pins				Function
Timer	TM0IO	P00	IRQ00			8-bit timer I/O pin
	TM1IO	P01	IRQ01			
	TM2IO	P42	CANTXD_B	SBO4		
	TM3IO	P43	CANRXD_B	SBI4		
	TM4IO	P02	IRQ02	CANTXD_A	EXTRG1	
	TM5IO	P03	IRQ03	CANRXD_A	EXTRG0	
	TM6IO	P40	SBCS3			
	TM7IO	P41	SBT4			
	TM8IO	P44	PWMBCST0			
	TM9IO	P45	PWMBCST1			
	TM10IO	P46	PWMBCST2			
	TM11IO	P47				
	TM12IO	P04	IRQ04			
	TM13IO	P05	IRQ05			
	TM14IO	P06	IRQ06			
	TM15IO	P07	IRQ07			
	TM28IO	P76				
	TM29IO	P77				
	TM16AIO	P50				16-bit timer I/O A, B pin
	TM16BIO	P51				
	TM17AIO	P54	PWM12_B			
	TM17BIO	P55	PWM13_B			
	TM18AIO	P60				
	TM18BIO	P61				
	TM19AIO	P64	PWM02_B			
	TM19BIO	P65	PWM03_B			
	TM20AIO	P70				
	TM20BIO	P71				
	TM21AIO	P72				
TM21BIO	P73					
TM22AIO	P74					
TM22BIO	P75					
TM23AIO	PB0	ADTRG0				
TM23BIO	PB1	ADTRG1				
TM24AIO	PB2	ADTRG2				

	Pins	Other Pins			Function
Timer	TM24BIO	PB3			16-bit timer I/O A, B pin
	TM25AIO	PB4			
	TM25BIO	PB5			
	TM16AO	P52	PWM10_B		16-bit timer Output A, B pin
	TM16BO	P53	PWM11_B		
	TM17AO	P56	PWM14_B		
	TM17BO	P57	PWM15_B		
	TM18AO	P62	PWM00_B		
	TM18BO	P63	PWM01_B		
	TM19AO	P66	PWM04_B		
	TM19BO	P67	PWM05_B		
	TM16AO_HR	P90	PWM10_A		
	TM16BO_HR	P91	PWM11_A		
	TM17AO_HR	P92	PWM12_A		
	TM17BO_HR	P93	PWM13_A		
	TM18AO_HR	P82	PWM02_A		
	TM18BO_HR	P83	PWM03_A		
	TM19AO_HR	P84	PWM04_A		
	TM19BO_HR	P85	PWM05_A		
	TM24AO_HR	P80	PWM00_A		
	TM24BO_HR	P81	PWM01_A		
	TM25AO_HR	P94	PWM14_A		
	TM25BO_HR	P95	PWM15_A		
PWM	PWM00_A	P80	TM24AO_HR		Motor control 3-phase PWM signal output pin
	PWM01_A	P81	TM24BO_HR		
	PWM02_A	P82	TM18AO_HR		
	PWM03_A	P83	TM18BO_HR		
	PWM04_A	P84	TM19AO_HR		
	PWM05_A	P85	TM19BO_HR		
	PWM10_A	P90	TM16AO_HR		
	PWM11_A	P91	TM16BO_HR		
	PWM12_A	P92	TM17AO_HR		
	PWM13_A	P93	TM17BO_HR		
	PWM14_A	P94	TM25AO_HR		
	PWM15_A	P95	TM25BO_HR		
	PWM00_B	P62	TM18AO		
	PWM01_B	P63	TM18BO		
	PWM02_B	P64	TM19AIO		

	Pins	Other Pins				Function	
PWM	PWM03_B	P65	TM19BIO			Motor control 3-phase PWM signal output pin	
	PWM04_B	P66	TM19AO				
	PWM05_B	P67	TM19BO				
	PWM10_B	P52	TM16AO				
	PWM11_B	P53	TM16BO				
	PWM12_B	P54	TM17AIO				
	PWM13_B	P55	TM17BIO				
	PWM14_B	P56	TM17AO				
	PWM15_B	P57	TM17BO				
	PWM20	PA0					
	PWM21	PA1					
	PWM22	PA2					
	PWM23	PA3					
	PWM24	PA4					
	PWM25	PA5					
	PWMBCST0	P44	TM8IO				Motor control 3-phase PWM counter state monitor pin
P45		TM9IO					
P46		TM10IO					
Serial	SBT0_A	P21	SBO0_B	SCL0_A	SDA0_B	Serial interface clock I/O pin	
	SBT0_B	P20	SBO0_A	SDA0_A	SCL0_B		
	SBT1_A	P24	SBO1_B	LINTXD_B			
	SBT1_B	P23	SBO1_A	LINTXD_A			
	SBT2_A	P31	SBO2_B				
	SBT2_B	P30	SBO2_A				
	SBT3_A	P34	SBO3_B				
	SBT3_B	P33	SBO3_A				
	SBT4	P41	TM7IO				
	SBO0_A	P20	SBT0_B	SDA0_A	SCL0_B		Serial interface data output pin
		SBO0_B	P21	SBT0_A	SCL0_A	SDA0_B	
		SBO1_A	P23	SBT1_B	LINTXD_A		
		SBO1_B	P24	SBT1_A	LINTXD_B		
		SBO2_A	P30	SBT2_B			
		SBO2_B	P31	SBT2_A			
		SBO3_A	P33	SBT3_B			
		SBO3_B	P34	SBT3_A			
		SBO4	P42	TM2IO	CANTXD_B		
		SBI0	P22				
	SBI1		P25	LINRXD			

	Pins	Other Pins				Function
Serial	SBI2	P32				Serial interface data input pin
	SBI3	P35				
	SBI4	P43	TM3IO	CANRXD_B		
	SBCS3	P40	TM6IO			Serial chip select I/O pin
IIC	SCL0_A	P21	SBT0_A	SBO0_B	SDA0_B	IIC clock I/O pin
	SCL0_B	P20	SBO0_A	SBT0_B	SDA0_A	
	SDA0_A	P20	SBO0_A	SBT0_B	SCL0_B	IIC communication I/O pin
	SDA0_B	P21	SBT0_A	SBO0_B	SCL0_A	
CAN	CANTXD_A	P02	IRQ02	TM4IO	EXTRG1	CAN communication output pin
	CANTXD_B	P42	TM2IO	SBO4		
	CANRXD_A	P03	IRQ03	TM5IO	EXTRG0	CAN communication input pin
	CANRXD_B	P43	TM3IO	SBI4		
LIN	LINTXD_A	P23	SBO1_A	SBT1_B		LIN communication output pin
	LINTXD_B	P24	SBT1_A	SBO1_B		
	LINRXD	P25	SBI1			LIN communication input pin
A/D converter	ADIN00	PC0	VGA0N	CMP0REF		Analog input pin for A/D converters
	ADIN01	PC1	VGA0P0	CMP0IN		
	ADIN02	PC2	VGA0P1			
	ADIN03	PC3	VGA0P2			
	ADIN04	PC4				
	ADIN05	PC5				
	ADIN06	PC6				
	ADIN07	PC7				
	ADIN08	PD0	VGA1N	CMP1REF		
	ADIN09	PD1	VGA1P0	CMP1IN		
	ADIN10	PD2	VGA1P1			
	ADIN11	PD3	VGA1P2			
	ADIN12	PD4				
	ADIN13	PD5				
	ADIN14	PD6				
	ADIN15	PD7				
	ADIN16	PE0	VGA2N	CMP2REF		
	ADIN17	PE1	VGA2P0	CMP2IN		
	ADIN18	PE2	VGA2P1			
	ADIN19	PE3	VGA2P2			
	ADIN20	PE4				
	ADIN21	PE5				
	ADIN22	PE6	DA0OUT			
	ADIN23	PE7	DA1OUT			
	ADIN24	PF0				
ADIN25	PF1					

	Pins	Other Pins				Function
A/D converter	ADIN26	PF2				Analog input pin for A/D converters
	ADIN27	PF3				
	ADTRG0	PB0	TM23AIO			A/D conversion trigger output pin
	ADTRG1	PB1	TM23BIO			
	ADTRG2	PB2	TM24AIO			
VGA(*1)	VGA0N	PC0	ADIN00	CMP0REF		Analog input pin for VGA
	VGA0P0	PC1	ADIN01	CMP0IN		
	VGA0P1	PC2	ADIN02			
	VGA0P2	PC3	ADIN03			
	VGA1N	PD0	ADIN08	CMP1REF		
	VGA1P0	PD1	ADIN09	CMP1IN		
	VGA1P1	PD2	ADIN10			
	VGA1P2	PD3	ADIN11			
	VGA2N	PE0	ADIN16	CMP2REF		
	VGA2P0	PE1	ADIN17	CMP2IN		
	VGA2P1	PE2	ADIN18			
	VGA2P2	PE3	ADIN19			
	Comparator	CMP0REF	PC0	ADIN00	VGA0N	
CMP1REF		PD0	ADIN08	VGA1N		
CMP2REF		PE0	ADIN16	VGA2N		
CMP0IN		PC1	ADIN01	VGA0P0		Input pin for comparator
CMP1IN		PD1	ADIN09	VGA1P0		
CMP2IN		PE1	ADIN17	VGA2P0		
CMP0OUT		P10	IRQ08			Output pin for comparator
CMP1OUT		P11	IRQ09			
CMP2OUT		P12	IRQ10			
D/A converter	DA0OUT	PE6	ADIN22			Output pin for D/A converter
	DA1OUT	PE7	ADIN23			
I/O port	P00	IRQ00	TM0IO			I/O port 0
	P01	IRQ01	TM1IO			
	P02	IRQ02	TM4IO	CANTXD_A	EXTRG1	
	P03	IRQ03	TM5IO	CANRXD_A	EXTRG0	
	P04	IRQ04	TM12IO			
	P05	IRQ05	TM13IO			
	P06	IRQ06	TM14IO			
	P07	IRQ07	TM15IO			
	P10	IRQ08	CMP0OUT			
	P11	IRQ09	CMP1OUT			
	P12	IRQ10	CMP2OUT			

	Pins	Other Pins				Function
I/O port	P13	IRQ11				I/O port 1
	P14	IRQ12				
	P15	IRQ13				
	P16	IRQ14				
	P17	IRQ15				
	P20	SBO0_A	SBT0_B	SDA0_A	SCL0_B	I/O port 2
	P21	SBT0_A	SBO0_B	SCL0_A	SDA0_B	
	P22	SBI0				
	P23	SBO1_A	SBT1_B	LINTXD_A		
	P24	SBT1_A	SBO1_B	LINTXD_B		
	P25	SBI1	LINRXD			
	P30	SBO2_A	SBT2_B			I/O port 3
	P31	SBT2_A	SBO2_B			
	P32	SBI2				
	P33	SBO3_A	SBT3_B			
	P34	SBT3_A	SBO3_B			
	P35	SBI3				
	P40	TM6IO	SBCS3			I/O port 4
	P41	TM7IO	SBT4			
	P42	TM2IO	CANTXD_B	SBO4		
	P43	TM3IO	CANRXD_B	SBI4		
	P44	TM8IO	PWMBCST0			
	P45	TM9IO	PWMBCST1			
	P46	TM10IO	PWMBCST2			
	P47	TM11IO				
	P50	TM16AIO				I/O port 5
	P51	TM16BIO				
	P52	TM16AO	PWM10_B			
P53	TM16BO	PWM11_B				
P54	TM17AIO	PWM12_B				
P55	TM17BIO	PWM13_B				
P56	TM17AO	PWM14_B				
P57	TM17BO	PWM15_B				
P60	TM18AIO				I/O port 6	
P61	TM18BIO					
P62	TM18AO	PWM00_B				
P63	TM18BO	PWM01_B				
P64	TM19AIO	PWM02_B				

	Pins	Other Pins				Function
I/O port	P65	TM19BIO	PWM03_B			I/O port 6
	P66	TM19AO	PWM04_B			
	P67	TM19BO	PWM05_B			
	P70	TM20AIO				I/O port 7
	P71	TM20BIO				
	P72	TM21AIO				
	P73	TM21BIO				
	P74	TM22AIO				
	P75	TM22BIO				
	P76	TM28IO				
	P77	TM29IO				
	P80	PWM00_A	TM24AO_HR			I/O port 8
	P81	PWM01_A	TM24BO_HR			
	P82	PWM02_A	TM18AO_HR			
	P83	PWM03_A	TM18BO_HR			
	P84	PWM04_A	TM19AO_HR			
	P85	PWM05_A	TM19BO_HR			
	P90	PWM10_A	TM16AO_HR			I/O port 9
	P91	PWM11_A	TM16BO_HR			
	P92	PWM12_A	TM17AO_HR			
	P93	PWM13_A	TM17BO_HR			
	P94	PWM14_A	TM25AO_HR			
	P95	PWM15_A	TM25BO_HR			
	PA0	PWM20				I/O port A
	PA1	PWM21				
	PA2	PWM22				
	PA3	PWM23				
	PA4	PWM24				
	PA5	PWM25				
	PB0	TM23AIO	ADTRG0			I/O port B
PB1	TM23BIO	ADTRG1				
PB2	TM24AIO	ADTRG2				
PB3	TM24BIO					
PB4	TM25AIO					
PB5	TM25BIO					
PC0	ADIN00	VGA0N	CMP0REF		Input(/Output) port C	
PC1	ADIN01	VGA0P0	CMP0IN			
PC2	ADIN02	VGA0P1				

	Pins	Other Pins				Function	
I/O port	PC3	ADIN03	VGA0P2			Input(/Output) port C	
	PC4	ADIN04					
	PC5	ADIN05					
	PC6	ADIN06					
	PC7	ADIN07					
	PD0	ADIN08	VGA1N	CMP1REF		Input(/Output) port D	
	PD1	ADIN09	VGA1P0	CMP1IN			
	PD2	ADIN10	VGA1P1				
	PD3	ADIN11	VGA1P2				
	PD4	ADIN12					
	PD5	ADIN13					
	PD6	ADIN14					
	PD7	ADIN15					
	PE0	ADIN16	VGA2N	CMP2REF		Input(/Output) port E	
	PE1	ADIN17	VGA2P0	CMP2IN			
	PE2	ADIN18	VGA2P1				
	PE3	ADIN19	VGA2P2				
	PE4	ADIN20					
	PE5	ADIN21					
	PE6	ADIN22	DA0OUT				
	PE7	ADIN23	DA1OUT				
	I/O port F	PF0	ADIN24				
		PF1	ADIN25				
		PF2	ADIN26				
		PF3	ADIN27				
		OBD	SCLK				
	SDATA						On-board debugger data I/O pin Connect the pull-up resistor of 10 kΩ or more.
	EXTRG0		P03	TM5IO	IRQ03	CANRXD_A	On-board debugger trigger I/O pin
EXTRG1	P02		TM4IO	IRQ02	CANTXD_A		



*1 VGA is not in MN103HF47 series.

1.5.3 Pin Functions (MN103HFx6)

The function of each pin is listed in Table:1.5.3.

Table:1.5.3 Pin Functions of MN103HFx6

	Pins	Other Pins				Function
Power supply/GND	VDD50					Power pin for digital IO Connect 1 μ F capacitor or more between all of the VDD50 and VSS pins. (Put the capacitor near the pins.)
	AVDD50					Power pin for analog Connect 1 μ F capacitor or more between AVDD50 and AVSS pins. (Put the capacitor near the pins.)
	VOUT18					Internal power pin Connect 1 μ F capacitors between VOUT18 and VSS pins. (Put the capacitor near the pins.)
	AVSS					GND for analog
	VSS					GND for digital
Function control	TEST					Test signal input pin Add the pull-up resistor of 2 k Ω or more. (Put the resistor near the pins.)
	TEST2					Add the pull-up resistor of 2 k Ω or more. (Put the resistor near the pins.)
Reset	NRST					Reset pins (negative logic) Connect 0.1 μ F capacitor or more between NRST and VSS pins.
Clock	OSCI					High-speed oscillation input pin
	OSCO					High-speed oscillation output pin
Interrupt	IRQ00	P00	TM0IO	DA0OUT		External interrupt input pin
	IRQ01	P01	TM1IO	DA1OUT		
	IRQ02	P02	TM4IO	CANTXD_A	EXTRG1	
	IRQ03	P03	TM5IO	CANRXD_A	EXTRG0	
	IRQ04	P04				
	IRQ05	P05				
	IRQ06	P06				
	IRQ07	P07				
	IRQ08	P10				
	IRQ09	P11				
	IRQ10	P42	TM2IO	CANTXD_B		
	IRQ11	P43	TM3IO	CANRXD_B		
	IRQ12	P70	TM20AIO	PWM02_B		
	IRQ13	P71	TM20BIO	PWM03_B		
	IRQ14	P72	TM21AIO	PWM04_B		
IRQ15	P73	TM21BIO	PWM05_B			

	Pins	Other Pins				Function
Timer	TM0IO	P00	IRQ00	DA0OUT		8-bit timer I/O pin
	TM1IO	P01	IRQ01	DA1OUT		
	TM2IO	P42	CANTXD_B	IRQ10		
	TM3IO	P43	CANRXD_B	IRQ11		
	TM4IO	P02	IRQ02	CANTXD_A	EXTRG1	
	TM5IO	P03	IRQ03	CANRXD_A	EXTRG0	
	TM6IO	P40	SBCS3			
	TM7IO	P41				
	TM8IO	P44	PWMBCST0			
	TM9IO	P45	PWMBCST1			
	TM10IO	P46				
TM11IO	P47					
TM16AIO	P50				16-bit timer I/O A, B pin	
TM16BIO	P51					
TM17AIO	P54	PWM12_B				
TM17BIO	P55	PWM13_B				
TM18AIO	P60					
TM18BIO	P61					
TM19AIO	P64					
TM19BIO	P65					
TM20AIO	P70	IRQ12	PWM02_B			
TM20BIO	P71	IRQ13	PWM03_B			
TM21AIO	P72	IRQ14	PWM04_B			
TM21BIO	P73	IRQ15	PWM05_B			
TM22AIO	P94	PWM14_A				
TM22BIO	P95	PWM15_A				
TM23AIO	PB0	ADTRG0				
TM23BIO	PB1	ADTRG1				
TM16AO	P52	PWM10_B			16-bit timer Output A, B pin	
TM16BO	P53	PWM11_B				
TM17AO	P56	PWM14_B				
TM17BO	P57	PWM15_B				
TM16AO_HR	P90	PWM10_A				
TM16BO_HR	P91	PWM11_A				
TM17AO_HR	P92	PWM12_A				
TM17BO_HR	P93	PWM13_A				
TM18AO_HR	P82	PWM02_A				
TM18BO_HR	P83	PWM03_A				
TM19AO_HR	P84	PWM04_A				
TM19BO_HR	P85	PWM05_A				

	Pins	Other Pins				Function
PWM	PWM00	P80				Motor control 3-phase PWM signal output pin
	PWM01	P81				
	PWM02_A	P82	TM18AO_HR			
	PWM03_A	P83	TM18BO_HR			
	PWM04_A	P84	TM19AO_HR			
	PWM05_A	P85	TM19BO_HR			
	PWM10_A	P90	TM16AO_HR			
	PWM11_A	P91	TM16BO_HR			
	PWM12_A	P92	TM17AO_HR			
	PWM13_A	P93	TM17BO_HR			
	PWM14_A	P94	TM22AIO			
	PWM15_A	P95	TM22BIO			
	PWM02_B	P70	IRQ12	TM20AIO		
	PWM03_B	P71	IRQ13	TM20BIO		
	PWM04_B	P72	IRQ14	TM21AIO		
	PWM05_B	P73	IRQ15	TM21BIO		
	PWM10_B	P52	TM16AO			
	PWM11_B	P53	TM16BO			
	PWM12_B	P54	TM17AIO			
	PWM13_B	P55	TM17BIO			
PWM14_B	P56	TM17AO				
PWM15_B	P57	TM17BO				
PWMBBCST0	P44	TM8IO			Motor control 3-phase PWM counter state monitor pin	
PWMBBCST1	P45	TM9IO				
Serial	SBT0_A	P21	SBO0_B	SCL0_A	SDA0_B	Serial interface clock I/O pin
	SBT0_B	P20	SBO0_A	SDA0_A	SCL0_B	
	SBT1_A	P24	SBO1_B	LINTXD_B		
	SBT1_B	P23	SBO1_A	LINTXD_A		
	SBT2_A	P31	SBO2_B			
	SBT2_B	P30	SBO2_A			
	SBT3_A	P34	SBO3_B			
	SBT3_B	P33	SBO3_A			
	SBO0_A	P20	SBT0_B	SDA0_A	SCL0_B	

	Pins	Other Pins				Function
Serial	SBO0_B	P21	SBT0_A	SCL0_A	SDA0_B	Serial interface data output pin
	SBO1_A	P23	SBT1_B	LINTXD_A		
	SBO1_B	P24	SBT1_A	LINTXD_B		
	SBO2_A	P30	SBT2_B			
	SBO2_B	P31	SBT2_A			
	SBO3_A	P33	SBT3_B			
	SBO3_B	P34	SBT3_A			
	SBI0	P22				Serial interface data input pin
	SBI1	P25	LINRXD			
	SBI2	P32				
	SBI3	P35				
SBCS3	P40	TM6IO			Serial chip select I/O pin	
IIC	SCL0_A	P21	SBT0_A	SBO0_B	SDA0_B	IIC clock I/O pin
	SCL0_B	P20	SBO0_A	SBT0_B	SDA0_A	
	SDA0_A	P20	SBO0_A	SBT0_B	SCL0_B	IIC communication I/O pin
	SDA0_B	P21	SBT0_A	SBO0_B	SCL0_A	
CAN	CANTXD_A	P02	IRQ02	TM4IO	EXTRG1	CAN communication output pin
	CANTXD_B	P42	TM2IO	IRQ10		
	CANRXD_A	P03	IRQ03	TM5IO	EXTRG0	CAN communication input pin
	CANRXD_B	P43	TM3IO	IRQ11		
LIN	LINTXD_A	P23	SBO1_A	SBT1_B		LIN communication output pin
	LINTXD_B	P24	SBT1_A	SBO1_B		
	LINRXD	P25	SBI1			LIN communication input pin
A/D converter	ADIN00	PC0	VGA0N	CMP0REF		Analog input pin for A/D converters
	ADIN01	PC1	VGA0P0	CMP0IN		
	ADIN02	PC2	VGA0P1			
	ADIN03	PC3	VGA0P2			
	ADIN04	PC4				
	ADIN05	PC5				
	ADIN06	PC6				
	ADIN07	PC7				
	ADIN08	PD0	VGA1N	CMP1REF		
	ADIN09	PD1	VGA1P0	CMP1IN		
	ADIN10	PD2	VGA1P1			
	ADIN11	PD3	VGA1P2			
	ADIN12	PD4				
	ADIN13	PD5				
	ADIN14	PD6				
	ADIN15	PD7				
	ADIN16	PE0	VGA2N	CMP2REF		
ADIN17	PE1	VGA2P	CMP2IN			

	Pins	Other Pins				Function
A/D converter	ADIN20	PE4				Analog input pin for A/D converters
	ADIN21	PE5				
	ADTRG0	PB0	TM23AIO			A/D conversion trigger output pin
	ADTRG1	PB1	TM23BIO			
	ADTRG2	PB2				
VGA(*1)	VGA0N	PC0	ADIN00	CMP0REF		Analog input pin for VGA
	VGA0P0	PC1	ADIN01	CMP0IN		
	VGA0P1	PC2	ADIN02			
	VGA0P2	PC3	ADIN03			
	VGA1N	PD0	ADIN08	CMP1REF		
	VGA1P0	PD1	ADIN09	CMP1IN		
	VGA1P1	PD2	ADIN10			
	VGA1P2	PD3	ADIN11			
	VGA2N	PE0	ADIN16	CMP2REF		
	VGA2P	PE1	ADIN17	CMP2IN		
Comparator	CMP0REF	PC0	ADIN00	VGA0N		Power supply pin for comparator
	CMP1REF	PD0	ADIN08	VGA1N		
	CMP2REF	PE0	ADIN16	VGA2N		
	CMP0IN	PC1	ADIN01	VGA0P0		Input pin for comparator
	CMP1IN	PD1	ADIN09	VGA1P0		
	CMP2IN	PE1	ADIN17	VGA2P		
	CMP0OUT	PB3				Output pin for comparator
	CMP1OUT	PB4				
	CMP2OUT	PB5				
D/A converter	DA0OUT	P00	IRQ00	TM0IO		Output pin for D/A converter
	DA1OUT	P01	IRQ01	TM1IO		
I/O port	P00	IRQ00	TM0IO	DA0OUT		I/O port 0
	P01	IRQ01	TM1IO	DA1OUT		
	P02	IRQ02	TM4IO	CANTXD_A	EXTRG1	
	P03	IRQ03	TM5IO	CANRXD_A	EXTRG0	
	P04	IRQ04				
	P05	IRQ05				
	P06	IRQ06				
	P07	IRQ07				
	P10	IRQ08				I/O port 1
	P11	IRQ09				
	P20	SBO0_A	SBT0_B	SDA0_A	SCL0_B	I/O port 2
	P21	SBT0_A	SBO0_B	SCL0_A	SDA0_B	
	P22	SBI0				

	Pins	Other Pins				Function
I/O port 2	P23	SBO1_A	SBT1_B	LINTXD_A		
	P24	SBT1_A	SBO1_B	LINTXD_B		
	P25	SBI1	LINRXD			
I/O port 3	P30	SBO2_A	SBT2_B			
	P31	SBT2_A	SBO2_B			
	P32	SBI2				
	P33	SBO3_A	SBT3_B			
	P34	SBT3_A	SBO3_B			
I/O port 4	P35	SBI3				
	P40	TM6IO	SBCS3			
	P41	TM7IO				
	P42	TM2IO	CANTXD_B	IRQ10		
	P43	TM3IO	CANRXD_B	IRQ11		
	P44	TM8IO	PWMBCST0			
	P45	TM9IO	PWMBCST1			
	P46	TM10IO				
	P47	TM11IO				
	I/O port 5	P50	TM16AIO			
P51		TM16BIO				
P52		TM16AO	PWM10_B			
P53		TM16BO	PWM11_B			
P54		TM17AIO	PWM12_B			
P55		TM17BIO	PWM13_B			
P56		TM17AO	PWM14_B			
P57		TM17BO	PWM15_B			
I/O port 6	P60	TM18AIO				
	P61	TM18BIO				
	P64	TM19AIO				
	P65	TM19BIO				
I/O port 7	P70	TM20AIO	IRQ12	PWM02_B		
	P71	TM20BIO	IRQ13	PWM03_B		
	P72	TM21AIO	IRQ14	PWM04_B		
	P73	TM21BIO	IRQ15	PWM05_B		
I/O port 8	P80	PWM00				
	P81	PWM01				
	P82	PWM02_A	TM18AO_HR			
	P83	PWM03_A	TM18BO_HR			
	P84	PWM04_A	TM19AO_HR			

	Pins	Other Pins				Function
I/O port	P85	PWM05_A	TM19BO_HR			I/O port 8
	P90	PWM10_A	TM16AO_HR			I/O port 9
	P91	PWM11_A	TM16BO_HR			
	P92	PWM12_A	TM17AO_HR			
	P93	PWM13_A	TM17BO_HR			
	P94	PWM14_A	TM22AIO			
	P95	PWM15_A	TM22BIO			
	PB0	TM23AIO	ADTRG0			I/O port B
	PB1	TM23BIO	ADTRG1			
	PB2	ADTRG2				
	PB3	CMP0OUT				
	PB4	CMP1OUT				
	PB5	CMP2OUT				
	PC0	ADIN00	VGA0N	CMP0REF		Input(/Output) port C
	PC1	ADIN01	VGA0P0	CMP0IN		
	PC2	ADIN02	VGA0P1			
	PC3	ADIN03	VGA0P2			
	PC4	ADIN04				
	PC5	ADIN05				
	PC6	ADIN06				
	PC7	ADIN07				
PD0	ADIN08	VGA1N	CMP1REF		Input(/Output) port D	
PD1	ADIN09	VGA1P0	CMP1IN			
PD2	ADIN10	VGA1P1				
PD3	ADIN11	VGA1P2				
PD4	ADIN12					
PD5	ADIN13					
PD6	ADIN14					
PD7	ADIN15					
PE0	ADIN16	VGA2N	CMP2REF		Input(/Output) port E	
PE1	ADIN17	VGA2P	CMP2IN			
PE4	ADIN20					
PE5	ADIN21					
OBD	SCLK					On-board debugger clock input pin Connect the pull-up resistor of 10 kΩ or more.
	SDATA					On-board debugger data I/O pin Connect the pull-up resistor of 10 kΩ or more.
	EXTRG0	P03	TM5IO	IRQ03	CANRXD_A	On-board debugger trigger I/O pin
	EXTRG1	P02	TM4IO	IRQ02	CANTXD_A	



*1 VGA is not in MN103HF46 series.

1.5.4 Pin Functions (MN103HFx5)

The function of each pin is listed in Table:1.5.4.

Table:1.5.4 Pin Functions of MN103HFx5

	Pins	Other Pins				Function
Power supply/GND	VDD50					Power pin for digital IO Connect 1 μ F capacitor or more between all of the VDD50 and VSS pins. (Put the capacitor near the pins.)
	AVDD50					Power pin for analog Connect 1 μ F capacitor or more between AVDD50 and AVSS pins. (Put the capacitor near the pins.)
	VOUT18					Internal power pin Connect 1 μ F capacitors between VOUT18 and VSS pins. (Put the capacitor near the pins.)
	AVSS					GND for analog
	VSS					GND for digital
Function control	TEST					Test signal input pin Add the pull-up resistor of 2 k Ω or more. (Put the resistor near the pins.)
	TEST2					Add the pull-up resistor of 2 k Ω or more. (Put the resistor near the pins.)
Reset	NRST					Reset pins (negative logic) Connect 0.1 μ F capacitor or more between NRST and VSS pins.
Clock	OSCI					High-speed oscillation input pin
	OSCO					High-speed oscillation output pin
Interrupt	IRQ00	P00	TM0IO	DA0OUT		External interrupt input pin
	IRQ01	P01	TM1IO	DA1OUT		
	IRQ02	P02	TM4IO	CANTXD_A	EXTRG1	
	IRQ03	P03	TM5IO	CANRXD_A	EXTRG0	
	IRQ04	P04				
	IRQ05	P05				
	IRQ06	P06				
	IRQ07	P07				
	IRQ08	P40	TM6IO			
	IRQ09	P41	TM7IO			
	IRQ10	P42	TM2IO	CANTXD_B		
	IRQ11	P43	TM3IO	CANRXD_B		

	Pins	Other Pins				Function
Timer	TM0IO	P00	IRQ00	DA0OUT		8-bit timer I/O pin
	TM1IO	P01	IRQ01	DA1OUT		
	TM2IO	P42	CANTXD_B	IRQ10		
	TM3IO	P43	CANRXD_B	IRQ11		
	TM4IO	P02	IRQ02	CANTXD_A	EXTRG1	
	TM5IO	P03	IRQ03	CANRXD_A	EXTRG0	
	TM6IO	P40	IRQ08			
	TM7IO	P41	IRQ09			
	TM8IO	P44	SBO2_A	SBT2_B		
	TM9IO	P45	SBT2_A	SBO2_B		
	TM10IO	P46	SBI2			
TM11IO	P47					
TM16AIO	P50	PWM02_B			16-bit timer I/O A, B pin	
TM16BIO	P51	PWM03_B				
TM17AIO	P54	PWM04_B				
TM17BIO	P55	PWM05_B				
TM18AIO	P60	PWM10_B				
TM18BIO	P61	PWM11_B	CMP2OUT			
TM19AIO	P64	PWMBCST0	CMP0OUT			
TM19BIO	P65	PWMBCST1	CMP1OUT			
TM20AIO	P90	PWM10_A	TM16AO_HR			
TM20BIO	P91	PWM11_A	TM16BO_HR			
TM21AIO	P92	PWM12_A	TM17AO_HR			
TM21BIO	P93	PWM13_A	TM17BO_HR			
TM22AIO	P94	PWM14				
TM22BIO	P95	PWM15				
TM23AIO	PB0	PWM12_B	ADTRG0			
TM23BIO	PB1	PWM13_B	ADTRG1			
TM16AO_HR	P90	PWM10_A	TM20AIO		16-bit timer Output A, B pin	
TM16BO_HR	P91	PWM11_A	TM20BIO			
TM17AO_HR	P92	PWM12_A	TM21AIO			
TM17BO_HR	P93	PWM13_A	TM21BIO			
TM18AO_HR	P82	PWM02_A				
TM18BO_HR	P83	PWM03_A				
TM19AO_HR	P84	PWM04_A				
TM19BO_HR	P85	PWM05_A				

	Pins	Other Pins				Function	
PWM	PWM00	P80				Motor control 3-phase PWM signal output pin	
	PWM01	P81					
	PWM02_A	P82	TM18AO_HR				
	PWM03_A	P83	TM18BO_HR				
	PWM04_A	P84	TM19AO_HR				
	PWM05_A	P85	TM19BO_HR				
	PWM10_A	P90	TM16AO_HR	TM20AIO			
	PWM11_A	P91	TM16BO_HR	TM20BIO			
	PWM12_A	P92	TM17AO_HR	TM21AIO			
	PWM13_A	P93	TM17BO_HR	TM21BIO			
	PWM02_B	P50	TM16AIO				
	PWM03_B	P51	TM16BIO				
	PWM04_B	P54	TM17AIO				
	PWM05_B	P55	TM17BIO				
	PWM10_B	P60	TM18AIO				
	PWM11_B	P61	TM18BIO	CMP2OUT			
	PWM12_B	PB0	TM23AIO	ADTRG0			
	PWM13_B	PB1	TM23BIO	ADTRG1			
	PWM14	P94	TM22AIO				
	PWM15	P95	TM22BIO				
PWM	PWMBBCST0	P64	TM19AIO	CMP0OUT		Motor control 3-phase PWM counter state monitor pin	
	PWMBBCST1	P65	TM19BIO	CMP1OUT			
Serial	SBT0_A	P21	SBO0_B	SCL0_A	SDA0_B	Serial interface clock I/O pin	
	SBT0_B	P20	SBO0_A	SDA0_A	SCL0_B		
	SBT1_A	P24	SBO1_B	LINTXD_B			
	SBT1_B	P23	SBO1_A	LINTXD_A			
	SBT2_A	P45	SBO2_B	TM9IO			
	SBT2_B	P44	SBO2_A	TM8IO			
	SBT3_A	P31	SBO3_B				
	SBT3_B	P30	SBO3_A				
	Serial	SBO0_A	P20	SBT0_B	SDA0_A	SCL0_B	Serial interface data output pin
		SBO0_B	P21	SBT0_A	SCL0_A	SDA0_B	
		SBO1_A	P23	SBT1_B	LINTXD_A		
		SBO1_B	P24	SBT1_A	LINTXD_B		
		SBO2_A	P44	SBT2_B	TM8IO		
		SBO2_B	P45	SBT2_A	TM9IO		
		SBO3_A	P30	SBT3_B			
		SBO3_B	P31	SBT3_A			

	Pins	Other Pins				Function	
Serial	SBI0	P22				Serial interface data input pin	
	SBI1	P25	LINRXD				
	SBI2	P46	TM10IO				
	SBI3	P32					
	SBCS3	P33	ADTRG2			Serial chip select I/O pin	
IIC	SCL0_A	P21	SBT0_A	SBO0_B	SDA0_B	IIC clock I/O pin	
	SCL0_B	P20	SBO0_A	SBT0_B	SDA0_A		
	SDA0_A	P20	SBO0_A	SBT0_B	SCL0_B	IIC communication I/O pin	
	SDA0_B	P21	SBT0_A	SBO0_B	SCL0_A		
CAN	CANTXD_A	P02	IRQ02	TM4IO	EXTRG1	CAN communication output pin	
	CANTXD_B	P42	TM2IO	IRQ10			
	CANRXD_A	P03	IRQ03	TM5IO	EXTRG0	CAN communication input pin	
	CANRXD_B	P43	TM3IO	IRQ11			
LIN	LINTXD_A	P23	SBO1_A	SBT1_B		LIN communication output pin	
	LINTXD_B	P24	SBT1_A	SBO1_B			
	LINRXD	P25	SBI1			LIN communication input pin	
A/D converter	ADIN00	PC0	VGA0N	CMP0REF		Analog input pin for A/D converters	
	ADIN01	PC1	VGA0P0	CMP0IN			
	ADIN02	PC2	VGA0P1				
	ADIN03	PC3	VGA0P2				
	ADIN04	PC4					
	ADIN05	PC5					
	ADIN06	PC6					
	ADIN07	PC7					
	ADIN08	PD0	VGA1N	CMP1REF			
	ADIN09	PD1	VGA1P0	CMP1IN			
	ADIN10	PD2	VGA1P1				
	ADIN11	PD3	VGA1P2				
	ADIN12	PD4					
	ADIN13	PD5					
	ADIN16	PE0	VGA2N	CMP2REF			
	ADIN17	PE1	VGA2P	CMP2IN			
	ADTRG0	PB0	TM23AIO	PWM12_B			A/D conversion trigger output pin
	ADTRG1	PB1	TM23BIO	PWM13_B			
	ADTRG2	P33	SBCS3				

	Pins	Other Pins				Function	
VGA(*1)	VGA0N	PC0	ADIN00	CMP0REF		Analog input pin for VGA	
	VGA0P0	PC1	ADIN01	CMP0IN			
	VGA0P1	PC2	ADIN02				
	VGA0P2	PC3	ADIN03				
	VGA1N	PD0	ADIN08	CMP1REF			
	VGA1P0	PD1	ADIN09	CMP1IN			
	VGA1P1	PD2	ADIN10				
	VGA1P2	PD3	ADIN11				
	VGA2N	PE0	ADIN16	CMP2REF			
	VGA2P	PE1	ADIN17	CMP2IN			
Comparator	CMP0REF	PC0	ADIN00	VGA0N		Power supply pin for comparator	
	CMP1REF	PD0	ADIN08	VGA1N			
	CMP2REF	PE0	ADIN16	VGA2N			
	CMP0IN	PC1	ADIN01	VGA0P0		Input pin for comparator	
	CMP1IN	PD1	ADIN09	VGA1P0			
	CMP2IN	PE1	ADIN17	VGA2P			
	CMP0OUT	P64	TM19AIO	PWMBBCST0		Output pin for comparator	
	CMP1OUT	P65	TM19BIO	PWMBBCST1			
CMP2OUT	P61	TM18BIO	PWM11_B				
D/A converter	DA0OUT	P00	IRQ00	TM0IO		Output pin for D/A converter	
	DA1OUT	P01	IRQ01	TM1IO			
I/O port	P00	IRQ00	TM0IO	DA0OUT		I/O port 0	
	P01	IRQ01	TM1IO	DA1OUT			
	P02	IRQ02	TM4IO	CANTXD_A	EXTRG1		
	P03	IRQ03	TM5IO	CANRXD_A	EXTRG0		
	P04	IRQ04					
	P05	IRQ05					
	P06	IRQ06					
	P07	IRQ07					
	P20	SBO0_A	SBT0_B	SDA0_A	SCL0_B		I/O port 2
	P21	SBT0_A	SBO0_B	SCL0_A	SDA0_B		
	P22	SBI0					
	P23	SBO1_A	SBT1_B	LINTXD_A			
	P24	SBT1_A	SBO1_B	LINTXD_B			
	P25	SBI1	LINRXD				
	P30	SBO3_A	SBT3_B				I/O port 3
	P31	SBT3_A	SBO3_B				
P32	SBI3						
P33	SBCS3	ADTRG2					

I/O port	Pins		Other Pins			Function
I/O port 4	P40	TM6IO	IRQ08			I/O port 4
	P41	TM7IO	IRQ09			
	P42	TM2IO	CANTXD_B	IRQ10		
	P43	TM3IO	CANRXD_B	IRQ11		
	P44	TM8IO	SBO2_A	SBT2_B		
	P45	TM9IO	SBT2_A	SBO2_B		
	P46	TM10IO	SBI2			
	P47	TM11IO				
I/O port 5	P50	TM16AIO	PWM02_B			I/O port 5
	P51	TM16BIO	PWM03_B			
	P54	TM17AIO	PWM04_B			
	P55	TM17BIO	PWM05_B			
I/O port 6	P60	TM18AIO	PWM10_B			I/O port 6
	P61	TM18BIO	PWM11_B	CMP2OUT		
	P64	TM19AIO	PWMBCST0	CMP0OUT		
	P65	TM19BIO	PWMBCST1	CMP1OUT		
I/O port 8	P80	PWM00				I/O port 8
	P81	PWM01				
	P82	PWM02_A	TM18AO_HR			
	P83	PWM03_A	TM18BO_HR			
	P84	PWM04_A	TM19AO_HR			
	P85	PWM05_A	TM19BO_HR			
I/O port 9	P90	PWM10_A	TM16AO_HR	TM20AIO		I/O port 9
	P91	PWM11_A	TM16BO_HR	TM20BIO		
	P92	PWM12_A	TM17AO_HR	TM21AIO		
	P93	PWM13_A	TM17BO_HR	TM21BIO		
	P94	PWM14	TM22AIO			
	P95	PWM15	TM22BIO			
I/O port B	PB0	TM23AIO	ADTRG0	PWM12_B		I/O port B
	PB1	TM23BIO	ADTRG1	PWM13_B		
Input(/Output) port C	PC0	ADIN00	VGA0N	CMP0REF		Input(/Output) port C
	PC1	ADIN01	VGA0P0	CMP0IN		
	PC2	ADIN02	VGA0P1			
	PC3	ADIN03	VGA0P2			
	PC4	ADIN04				
	PC5	ADIN05				
	PC6	ADIN06				
	PC7	ADIN07				

	Pins	Other Pins				Function
I/O port	PD0	ADIN08	VGA1N	CMP1REF		Input(/Output) port D
	PD1	ADIN09	VGA1P0	CMP1IN		
	PD2	ADIN10	VGA1P1			
	PD3	ADIN11	VGA1P2			
	PD4	ADIN12				
	PD5	ADIN13				
	PE0	ADIN16	VGA2N	CMP2REF		Input port E
	PE1	ADIN17	VGA2P	CMP2IN		
OBD	SCLK					On-board debugger clock input pin Connect the pull-up resistor of 10 kΩ or more.
	SDATA					On-board debugger data I/O pin Connect the pull-up resistor of 10 kΩ or more.
	EXTRG0	P03	TM5IO	IRQ03	CANRXD_A	On-board debugger trigger I/O pin
	EXTRG1	P02	TM4IO	IRQ02	CANTXD_A	



*1 VGA is not in MN103HF45 series.

1.5.5 Pin Functions (MN103HFx4)

The function of each pin is listed in Table:1.5.5.

Table:1.5.5 Pin Functions of MN103HFx4

	Pins	Other Pins				Function
Power supply/GND	VDD50					Power pin for digital IO Connect 1 μ F capacitor or more between all of the VDD50 and VSS pins. (Put the capacitor near the pins.)
	AVDD50					Power pin for analog Connect 1 μ F capacitor or more between AVDD50 and AVSS pins. (Put the capacitor near the pins.)
	VOUT18					Internal power pin Connect 1 μ F capacitors between VOUT18 and VSS pins. (Put the capacitor near the pins.)
	AVSS					GND for analog
	VSS					GND for digital
Function control	TEST					Test signal input pin Add the pull-up resistor of 2 k Ω or more. (Put the resistor near the pins.)
	TEST2					Add the pull-up resistor of 2 k Ω or more. (Put the resistor near the pins.)
Reset	NRST					Reset pins (negative logic) Connect 0.1 μ F capacitor or more between NRST and VSS pins.
Clock	OSCI					High-speed oscillation input pin
	OSCO					High-speed oscillation output pin
Interrupt	IRQ00	P00	TM0IO	DA0OUT		External interrupt input pin
	IRQ01	P01	TM1IO	DA1OUT		
	IRQ02	P02	TM4IO	CANTXD_A	EXTRG1	
	IRQ03	P03	TM5IO	CANRXD_A	EXTRG0	
	IRQ04	P46	TM10IO	TM17AIO	PWM04_B	
	IRQ05	P47	TM11IO	TM17BIO	PWM05_B	
	IRQ08	P40	TM6IO			
	IRQ09	P41	TM7IO			
	IRQ10	P42	TM2IO	CANTXD_B		
	IRQ11	P43	TM3IO	CANRXD_B		

	Pins	Other Pins				Function
Timer	TM0IO	P00	IRQ00	DA0OUT		8-bit timer I/O pin
	TM1IO	P01	IRQ01	DA1OUT		
	TM2IO	P42	CANTXD_B	IRQ10		
	TM3IO	P43	CANRXD_B	IRQ11		
	TM4IO	P02	IRQ02	CANTXD_A	EXTRG1	
	TM5IO	P03	IRQ03	CANRXD_A	EXTRG0	
	TM6IO	P40	IRQ08			
	TM7IO	P41	IRQ09			
	TM10IO	P46	TM17AIO	IRQ04	PWM04_B	
	TM11IO	P47	TM17BIO	IRQ05	PWM05_B	
	Timer	TM16AIO	P50	PWM02_B	ADTRG0	
TM16BIO		P51	PWM03_B	ADTRG1		
TM17AIO		P46	PWM04_B	TM10IO	IRQ04	
TM17BIO		P47	PWM05_B	TM11IO	IRQ05	
TM18AIO		P60	PWM10_B			
TM18BIO		P61	PWM11_B			
TM19AIO		P64	PWMBBCST0	CMP0OUT		
TM19BIO		P65	PWMBBCST1	CMP1OUT		
TM20AIO		P90	PWM10_A	TM16AO_HR		
TM20BIO		P91	PWM11_A	TM16BO_HR		
Timer		TM21AIO	P92	PWM12	TM17AO_HR	
	TM21BIO	P93	PWM13	TM17BO_HR		
	TM16AO_HR	P90	PWM10_A	TM20AIO		
	TM16BO_HR	P91	PWM11_A	TM20BIO		
	TM17AO_HR	P92	PWM12	TM21AIO		
	TM17BO_HR	P93	PWM13	TM21BIO		
	TM18AO_HR	P82	PWM02_A			
	TM18BO_HR	P83	PWM03_A			
TM19AO_HR	P84	PWM04_A				
TM19BO_HR	P85	PWM05_A				

	Pins	Other Pins				Function
PWM	PWM00	P80				Motor control 3-phase PWM signal output pin
	PWM01	P81				
	PWM02_A	P82	TM18AO_HR			
	PWM03_A	P83	TM18BO_HR			
	PWM04_A	P84	TM19AO_HR			
	PWM05_A	P85	TM19BO_HR			
	PWM10_A	P90	TM16AO_HR	TM20AIO		
	PWM11_A	P91	TM16BO_HR	TM20BIO		
	PWM02_B	P50	TM16AIO	ADTRG0		
	PWM03_B	P51	TM16BIO	ADTRG1		
	PWM04_B	P46	TM17AIO	TM10IO	IRQ04	
	PWM05_B	P47	TM17BIO	TM11IO	IRQ05	
	PWM10_B	P60	TM18AIO			
	PWM11_B	P61	TM18BIO			
	PWM12	P92	TM17AO_HR	TM21AIO		
	PWM13	P93	TM17BO_HR	TM21BIO		
	PWM14	P94				
	PWM15	P95				
	PWMBBCST0	P64	TM19AIO	CMP0OUT		Motor control 3-phase PWM counter state monitor pin
PWMBBCST1	P65	TM19BIO	CMP1OUT			
Serial	SBT0_A	P21	SBO0_B	SCL0_A	SDA0_B	Serial interface clock I/O pin
	SBT0_B	P20	SBO0_A	SDA0_A	SCL0_B	
	SBT1_A	P24	SBO1_B	LINTXD_B		
	SBT1_B	P23	SBO1_A	LINTXD_A		
	SBT3_A	P31	SBO3_B			
	SBT3_B	P30	SBO3_A			
	SBO0_A	P20	SBT0_B	SDA0_A	SCL0_B	Serial interface data output pin
	SBO0_B	P21	SBT0_A	SCL0_A	SDA0_B	
	SBO1_A	P23	SBT1_B	LINTXD_A		
	SBO1_B	P24	SBT1_A	LINTXD_B		
	SBO3_A	P30	SBT3_B			
	SBO3_B	P31	SBT3_A			
	SBI0	P22				Serial interface data input pin
	SBI1	P25	LINRXD			
	SBI3	P32				
	SBCS3	P33	ADTRG2			Serial chip select I/O pin
IIC	SCL0_A	P21	SBT0_A	SBO0_B	SDA0_B	IIC clock I/O pin
	SCL0_B	P20	SBO0_A	SBT0_B	SDA0_A	
	SDA0_A	P20	SBO0_A	SBT0_B	SCL0_B	IIC communication I/O pin
	SDA0_B	P21	SBT0_A	SBO0_B	SCL0_A	

	Pins	Other Pins				Function
CAN	CANTXD_A	P02	IRQ02	TM4IO	EXTRG1	CAN communication output pin
	CANTXD_B	P42	TM2IO	IRQ10		
	CANRXD_A	P03	IRQ03	TM5IO	EXTRG0	CAN communication input pin
	CANRXD_B	P43	TM3IO	IRQ11		
LIN	LINTXD_A	P23	SBO1_A	SBT1_B		LIN communication output pin
	LINTXD_B	P24	SBT1_A	SBO1_B		
	LINRXD	P25	SBI1			LIN communication input pin
A/D converter	ADIN00	PC0	VGA0N	CMP0REF		Analog input pin for A/D converters
	ADIN01	PC1	VGA0P	CMP0IN		
	ADIN02	PC2				
	ADIN03	PC3				
	ADIN04	PC4				
	ADIN05	PC5				
	ADIN06	PC6				
	ADIN07	PC7				
	ADIN08	PD0	VGA1N	CMP1REF		
	ADIN09	PD1	VGA1P	CMP1IN		
	ADIN14	PD6				
	ADIN15	PD7				
	ADTRG0	P50	TM16AIO	PWM02_B		A/D conversion trigger output pin
	ADTRG1	P51	TM16BIO	PWM03_B		
	ADTRG2	P33	SBCS3			
VGA(*1)	VGA0N	PC0	ADIN00	CMP0REF		Analog input pin for VGA
	VGA0P	PC1	ADIN01	CMP0IN		
	VGA1N	PD0	ADIN08	CMP1REF		
	VGA1P	PD1	ADIN09	CMP1IN		
Comparator	CMP0REF	PC0	ADIN00	VGA0N		Power supply pin for comparator
	CMP1REF	PD0	ADIN08	VGA1N		
	CMP0IN	PC1	ADIN01	VGA0P		Input pin for comparator
	CMP1IN	PD1	ADIN09	VGA1P		
	CMP0OUT	P64	TM19AIO	PWMBBCST0		Output pin for comparator
	CMP1OUT	P65	TM19BIO	PWMBBCST1		
D/A converter	DA0OUT	P00	IRQ00	TM0IO		Output pin for D/A converter
	DA1OUT	P01	IRQ01	TM1IO		
I/O port	P00	IRQ00	TM0IO	DA0OUT		I/O port 0
	P01	IRQ01	TM1IO	DA1OUT		
	P02	IRQ02	TM4IO	CANTXD_A	EXTRG1	
	P03	IRQ03	TM5IO	CANRXD_A	EXTRG0	

	Pins	Other Pins				Function
I/O port	P20	SBO0_A	SBT0_B	SDA0_A	SCL0_B	I/O port 2
	P21	SBT0_A	SBO0_B	SCL0_A	SDA0_B	
	P22	SBI0				
	P23	SBO1_A	SBT1_B	LINTXD_A		
	P24	SBT1_A	SBO1_B	LINTXD_B		
	P25	SBI1	LINRXD			
	P30	SBO3_A	SBT3_B			I/O port 3
	P31	SBT3_A	SBO3_B			
	P32	SBI3				
	P33	SBCS3	ADTRG2			
	P40	TM6IO	IRQ08			I/O port 4
	P41	TM7IO	IRQ09			
	P42	TM2IO	CANTXD_B	IRQ10		
	P43	TM3IO	CANRXD_B	IRQ11		
	P46	TM10IO	TM17AIO	IRQ04	PWM04_B	
	P47	TM11IO	TM17BIO	IRQ05	PWM05_B	
	P50	TM16AIO	PWM02_B	ADTRG0		
	P51	TM16BIO	PWM03_B	ADTRG1		
	P60	TM18AIO	PWM10_B			I/O port 6
	P61	TM18BIO	PWM11_B			
	P64	TM19AIO	PWMBCST0	CMP0OUT		
	P65	TM19BIO	PWMBCST1	CMP1OUT		
	P80	PWM00				I/O port 8
	P81	PWM01				
P82	PWM02_A	TM18AO_HR				
P83	PWM03_A	TM18BO_HR				
P84	PWM04_A	TM19AO_HR				
P85	PWM05_A	TM19BO_HR				
P90	PWM10_A	TM16AO_HR	TM20AIO		I/O port 9	
P91	PWM11_A	TM16BO_HR	TM20BIO			
P92	PWM12	TM17AO_HR	TM21AIO			
P93	PWM13	TM17BO_HR	TM21BIO			
P94	PWM14					
P95	PWM15					

	Pins	Other Pins				Function	
I/O port	PC0	ADIN00	VGA0N	CMP0REF		Input(/Output) port C	
	PC1	ADIN01	VGA0P	CMP0IN			
	PC2	ADIN02					
	PC3	ADIN03					
	PC4	ADIN04					
	PC5	ADIN05					
	PC6	ADIN06					
	PC7	ADIN07					
	PD0	ADIN08	VGA1N	CMP1REF		Input(/Output) port D	
	PD1	ADIN09	VGA1P	CMP1IN			
	PD6	ADIN14					
	PD7	ADIN15					
	OBD	SCLK					On-board debugger clock input pin Connect the pull-up resistor of 10 kΩ or more.
		SDATA					On-board debugger data I/O pin Connect the pull-up resistor of 10 kΩ or more.
EXTRG0		P03	TM5IO	IRQ03	CANRXD_A	On-board debugger trigger I/O pin	
EXTRG1		P02	TM4IO	IRQ02	CANTXD_A		



*1 VGA is not in MN103HF44 series.

1.6 Electrical Characteristics

This LSI manual describes the standard specification.



Electrical characteristics given in this section are preliminary and subject to change without notice. When using LSI, contact our sales office for product specifications.

Model	CMOS LSI
Application	General-purpose
Function	CMOS 32-bit 1 chip microcontroller

1.6.1 Absolute Maximum Ratings

$V_{SS}=AV_{SS}=0.0\text{ V}$

Parameter		Symbol	Rating	Unit	
A1	External supply voltage 1	V_{DD50A}	-0.3 to +7.0	V	
A2	External supply voltage 2	AV_{DD50A}	-0.3 to +7.0		
A3	Internal supply voltage	V_{OUT18A}	-0.3 to +2.5		
A4	Input pin voltage	V_{I1A}	-0.3 to V_{DD50} +0.3 (upper limit: 7.0)		
A5	Input pin voltage for VGA	V_{I2A}	-1.5 to V_{DD50} +0.3 (upper limit: 7.0)		
A6	I/O pin voltage	V_{IOA}	-0.3 to V_{DD50} +0.3 (upper limit: 7.0)		
A7	Average output current (I/O pin 1)	I_{O1A}	± 8.0	mA	
A8	Average output current (I/O pin 2)	I_{O2A}	± 15.0		
A9	Operating ambient temperature	T_{OPRA}	-40 to 125	°C	
A10	Storage temperature	T_{STGA}	-40 to 125		
A11	Power dissipation	P_{DA}	MN103HFx8 Series	500	mW
			MN103HFx7 Series	380	
			MN103HFx6 Series	420	
			MN103HFx5 Series	410	
			MN103HFx4 Series	410	

Note: The absolute maximum ratings are the limit values beyond which the LSI may be damaged.

It is not guarantee the operation in these conditions.

The rating of the average output current is applied for the period of any 100 ms.

Note: Power dissipation is calculated based on our evaluation board, glass epoxy board (four-layer) [50 × 50 × 0.8t](mm).

Keep a margin enough in thermal design in actual use.

1.6.2 Operating Conditions

Operating Supply Voltage

$V_{SS} = AV_{SS} = 0.0\text{ V}$
 $T_a = -40\text{ }^\circ\text{C to } +125\text{ }^\circ\text{C}$

Parameter	Symbol	Conditions	Limits			Unit
			MIN	TYP	MAX	
B1	External supply voltage1	V_{DD50}	V_{RST}	5.0	5.5	V
B2	External supply voltage2	AV_{DD50}	V_{RST}	V_{DD50}	5.5	

Note: For the supply voltage detection level V_{RST} , refer to "Auto-reset circuit characteristics" on page I-70.

Note: Internal regulator output can not be used for supply to other LSI.

Oscillation input

$V_{DD50} = AV_{DD50} = V_{RST}$ to 5.5 V
 $V_{SS} = AV_{SS} = 0.0\text{ V}$
 $T_a = -40\text{ }^\circ\text{C to } 125\text{ }^\circ\text{C}$

Parameter	Symbol	Conditions	Limits			Unit
			MIN	TYP	MAX	
B3	Input frequency	F_{OSC}	4		16	MHz
B4	Internal feedback resistance	F_{FB}		1.2		$M\Omega$

Note: A capacity value changes by each oscillator. To decide appropriate capacity value, please consult the oscillator manufacturer and perform matching tests enough.

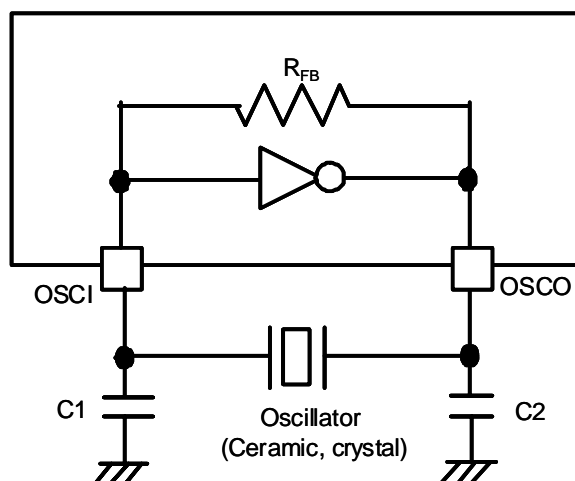

Figure:1.6.1 Oscillation Circuit

$V_{DD50} = AV_{DD50} = V_{RST}$ to 5.5 V

$V_{SS} = AV_{SS} = 0.0$ V

$T_a = -40$ °C to 125 °C

External clock input OSCI (OSCO left open)

Parameter	Symbol	Conditions	Limits			Unit
			MIN	TYP	MAX	
B5	Clock frequency	F_{cp}	4		16	MHz
B6	High-level pulse width	t_{wh1}	25			ns
B7	Low-level pulse width	t_{wl1}	25			
B8	Rise time	t_{wr1}			5	ns
B9	Fall time	t_{wf1}			5	

Note: Be sure that the clock duty ratio is 45 % to 55 %.

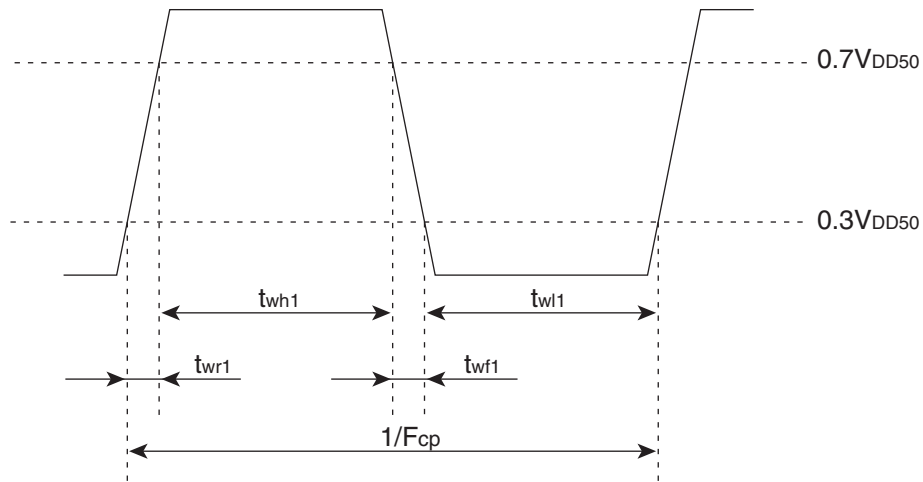

Figure:1.6.2 OSCI Timing Chart

1.6.3 DC Characteristics

 $V_{SS} = AV_{SS} = 0.0 \text{ V}$
 $T_a = -40 \text{ }^\circ\text{C to } 125 \text{ }^\circ\text{C}$

Output pins left open

Power supply current during operation

Parameter	Symbol	Conditions	Limits		Unit
			TYP	MAX	
C1	I_{DD1}	$V_{DD50} = 5.0 \text{ V}$, $F_{osc} = 10.0 \text{ MHz}$, PLL is used, MCLK = 120.0 MHz, IOCLK = 30.0 MHz Peripheral circuits are stopped.	38		mA
C2					
C3	I_{DD3}	$V_{DD50} = 5.0 \text{ V}$, $F_{osc} = 10.0 \text{ MHz}$, PLL is used, MCLK = 120.0 MHz, IOCLK = 30.0 MHz Peripheral circuits are operating.	30	47	
C4					
C5	I_{DD5}	$V_{DD50} = 5.0 \text{ V}$ F_{osc} is stopped, PLL is stopped.	$T_a = 25 \text{ }^\circ\text{C}$	0.2	
C6			$T_a = 125 \text{ }^\circ\text{C}$	10	

 $V_{DD50} = AV_{DD50} = 5.0 \text{ V}$
 $V_{SS} = AV_{SS} = 0.0 \text{ V}$
 $T_a = -40 \text{ }^\circ\text{C to } 125 \text{ }^\circ\text{C}$

Input pin 1 NRST, SCLK, SDATA

Parameter	Symbol	Conditions	Limits			Unit	
			MIN	TYP	MAX		
C7	Input voltage High level	V_{IH1}	$V_{DD50} \times 0.7$		V_{DD50}	V	
C8	Input voltage Low level	V_{IL1}	V_{SS}		$V_{DD50} \times 0.3$		
C9	Internal pull-up resistance	R_{IO1}	$V_{DD50} = 5.0 \text{ V}$, $V_{IN} = 0.0 \text{ V}$	15	30	60	k Ω

 $V_{DD50} = AV_{DD50} = 5.0 \text{ V}$
 $V_{SS} = AV_{SS} = 0.0 \text{ V}$
 $T_a = -40 \text{ }^\circ\text{C to } 125 \text{ }^\circ\text{C}$

Input pin 2 TEST2, TEST

Parameter	Symbol	Conditions	Limits			Unit
			MIN	TYP	MAX	
C10	Input voltage High level	V_{IH2}	$V_{DD50} \times 0.7$		V_{DD50}	V
C11	Input voltage Low level	V_{IL2}	V_{SS}		$V_{DD50} \times 0.3$	

$V_{DD50} = AV_{DD50} = 5.0\text{ V}$

$V_{SS} = AV_{SS} = 0.0\text{ V}$

$T_a = -40\text{ }^\circ\text{C to }125\text{ }^\circ\text{C}$

Input pin 3 PC0 to PC3, PD0 to PD3, PE0 to PE3

Parameter	Symbol	Conditions	Limits			Unit	
			MIN	TYP	MAX		
C12	Input voltage High level	V_{IH3}	When not using VGA	$V_{DD50} \times 0.7$		V_{DD50}	V
C13	Input voltage Low level	V_{IL3}	When not using VGA	V_{SS}		$V_{DD50} \times 0.3$	
C14	Input leakage current	I_{LK3}				± 5	μA
C15	VGA input voltage range 1	V_{IVGA1}	VGA Gain = 2 times	-1.00		1.00	V
C16	VGA input voltage range 2	V_{IVGA2}	VGA Gain = 3 times	-0.66		0.66	
C17	VGA input voltage range 3	V_{IVGA3}	VGA Gain = 4 times	-0.50		0.50	
C18	VGA input voltage range 4	V_{IVGA4}	VGA Gain = 5 times	-0.40		0.40	
C19	VGA input voltage range 5	V_{IVGA5}	VGA Gain = 6 times	-0.33		0.33	
C20	VGA input voltage range 6	V_{IVGA6}	VGA Gain = 8 times	-0.25		0.25	
C21	VGA input voltage range 7	V_{IVGA7}	VGA Gain = 10 times	-0.20		0.20	
C22	VGA input voltage range 8	V_{IVGA8}	VGA Gain = 20 times	-0.10		0.10	

I/O pin 1

<MN103HFx8 Series > P00 to P07, P10 to P17, P20 to P27, P30 to P37, P40 to P47, P76, P77, P86, P87, P96, P97, PC4 to PC7, PD4 to PD7, PE4 to PE7, PF0 to PF7

<MN103HFx7 Series > P00 to P07, P10 to P17, P20 to P25, P30 to P35, P40 to P47, P76, P77, PC4 to PC7, PD4 to PD7, PE4 to PE7, PF0 to PF3

<MN103HFx6 Series > P00 to P07, P11, P20 to P25, P30 to P35, P40 to P47, PB0 to PB5, PC4 to PC7, PD4 to PD7, PE4, PE5

<MN103HFx5 Series > P00 to P07, P20 to P25, P30 to P33, P40 to P47, PC4 to PC7, PD4, PD5

<MN103HFx4 Series > P00 to P03, P20 to P25, P30 to P33, P40 to P43, PC4 to PC7, PD6, PD7

$V_{DD50} = AV_{DD50} = 5.0\text{ V}$

$V_{SS} = AV_{SS} = 0.0\text{ V}$

$T_a = -40\text{ }^\circ\text{C to }125\text{ }^\circ\text{C}$

Parameter	Symbol	Conditions	Limits			Unit	
			MIN	TYP	MAX		
C23	Input voltage High level	V_{IH4}		$V_{DD50} \times 0.7$		V_{DD50}	V
C24	Input voltage Low level	V_{IL4}		V_{SS}		$V_{DD50} \times 0.3$	
C25	Input leakage current	I_{LK4}				± 5	μA
C26	Internal pull-up resistance	R_{IO4}	$V_{DD50} = 5.0\text{ V}, V_{IN} = 0.0\text{ V}$	15	30	60	$\text{k}\Omega$
C27	Output voltage High level	V_{OH4}	$V_{DD50} = 5.0\text{ V}, I_{OH} = -2.5\text{ mA}$	4.5			V
C28	Output voltage Low level	V_{OL4}	$V_{DD50} = 5.0\text{ V}, I_{OL} = 2.5\text{ mA}$			0.5	

I/O pin 2

<MN103HFx8 Series > P50 to P57, P60 to P67, P70 to P75, P80 to P85, P90 to P95, PA0 to PA5, PB0 to PB5

<MN103HFx7 Series > P50 to P57, P60 to P67, P70 to P75, P80 to P85, P90 to P95, PA0 to PA5, PB0 to PB5

<MN103HFx6 Series > P10, P50 to P57, P60, P61, P64, P65, P70 to P73, P80 to P85, P90 to P95

<MN103HFx5 Series > P50, P51, P54, P55, P60, P61, P64, P65, P80 to P85, P90 to P95, PB0, PB1

<MN103HFx4 Series > P46, P47, P50, P51, P60, P61, P64, P65, P80 to P85, P90 to P95

 $V_{DD50} = AV_{DD50} = 5.0 \text{ V}$
 $V_{SS} = AV_{SS} = 0.0 \text{ V}$
 $T_a = -40 \text{ }^\circ\text{C to } 125 \text{ }^\circ\text{C}$

Parameter	Symbol	Conditions	Limits			Unit
			MIN	TYP	MAX	
C29	Input voltage High level	V_{IH5}	$V_{DD50} \times 0.7$		V_{DD50}	V
C30	Input voltage Low level	V_{IL5}	V_{SS}		$V_{DD50} \times 0.3$	
C31	Input leakage current	I_{LK5}			± 5	μA
C32	Internal pull-up resistance	R_{IO5}	$V_{DD50} = 5.0 \text{ V}, V_{IN} = 0.0 \text{ V}$			k Ω
C33	Output voltage High level	V_{OH5}	$V_{DD50} = 5.0 \text{ V}, V_{OH} = -5.0 \text{ mA}$			
C34	Output voltage Low level	V_{OL5}	$V_{DD50} = 5.0 \text{ V}, V_{OL} = 5.0 \text{ mA}$			V

1.6.4 Analog Characteristics

$$V_{DD50} = AV_{DD50} = 5.0 \text{ V}$$

$$V_{SS} = AV_{SS} = 0.0 \text{ V}$$

$$T_a = -40 \text{ }^\circ\text{C to } 125 \text{ }^\circ\text{C}$$

A/D0, A/D1

Parameter	Symbol	Conditions	Limits			Unit
			MIN	TYP	MAX.	
D1	Resolution	-			12	Bits
D2	Integral non-linearity error	INLE			± 3	LSB
D3	Differential non-linearity error	DNLE			± 3	LSB
D4	Zero transition voltage	-	-20		20	mV
D5	Full-scale transition voltage	-	4980		5020	mV
D6	A/D conversion time	-	0.600			μs
D7		-	0.534			
D8	Analog input voltage	V_{IA}	AV_{SS}		AV_{DD50}	V
D9	Analog input leakage current	I_{IA}	When channel is not selected $V_{IA} = 0 \text{ V to } AV_{DD50}$		± 5	μA
D10	Power supply current during operation (AVDD50 pin)	I_{AD}	A/D conversion clock = 30 MHz		1	mA/unit

$$V_{DD50} = AV_{DD50} = 5.0 \text{ V}$$

$$V_{SS} = AV_{SS} = 0.0 \text{ V}$$

$$T_a = -40 \text{ }^\circ\text{C to } 125 \text{ }^\circ\text{C}$$

A/D2

Parameter	Symbol	Conditions	Limits			Unit
			MIN	TYP	MAX.	
D11	Resolution	-			10	Bits
D12	Integral non-linearity error	INLE			± 2	LSB
D13	Differential non-linearity error	DNLE			± 3	LSB
D14	Zero transition voltage	-	-20		20	mV
D15	Full-scale transition voltage	-	4980		5020	mV
D16	A/D conversion time	-	0.5			μs
D17	Analog input voltage	V_{IA}	AV_{SS}		AV_{DD50}	V
D18	Analog input leakage current	I_{IA}	When channel is not selected $V_{IA} = 0 \text{ V to } AV_{DD50}$		± 5	μA
D19	Power supply current during operation (AVDD50 pin)	I_{AD}	A/D conversion clock = 30 MHz		1	mA

$V_{DD50} = AV_{DD50} = 5.0 \text{ V}$
 $V_{SS} = AV_{SS} = 0.0 \text{ V}$
 $T_a = -40 \text{ }^\circ\text{C to } 125 \text{ }^\circ\text{C}$

VGA0, VGA1, VGA2

Parameter	Symbol	Conditions	Limits			Unit
			MIN	TYP	MAX.	
D20	V_{gaerr1}	GAIN = 2,3,4 or 5 times		± 1.0	± 1.5	%
D21		GAIN = 6,8 or 10 times		± 1.2	± 1.6	
D22		GAIN = 20 times		± 1.5	± 1.8	
D23	$V_{gaoffset1}$	GAIN = 2,3,4 or 5 times	-70	-30	10	mV
D24		GAIN = 6,8 or 10 times	-110	-40	30	
D25		GAIN = 20 times	-130	-45	40	
D26	Settling time	T_{vgaset}			0.6	μs
D27	Power supply current during operation (AVDD50 pin)	I_{VGA}		1.4		mA

 $V_{DD50} = AV_{DD50} = 5.0 \text{ V}$
 $V_{SS} = AV_{SS} = 0.0 \text{ V}$
 $T_a = -40 \text{ }^\circ\text{C to } 125 \text{ }^\circ\text{C}$

CMP0, CMP1, CMP2

Parameter	Symbol	Conditions	Limits			Unit
			MIN	TYP	MAX.	
D28	Input offset voltage	$V_{cmpoffset}$		± 5	± 25	mV
D29	Input dynamic range		50		4950	
D30	Input hysteresis width	Hysteresis setting is ON.		30		
		Hysteresis setting is OFF.		0		
D31	Response time			30		ns
D32	Power supply current during operation (AVDD50 pin)	I_{COMP}		0.3		mA

 $V_{DD50} = AV_{DD50} = 5.0 \text{ V}$
 $V_{SS} = AV_{SS} = 0.0 \text{ V}$
 $T_a = -40 \text{ }^\circ\text{C to } 125 \text{ }^\circ\text{C}$

D/A0, D/A1, D/A2

Parameter	Symbol	Conditions	Limits			Unit
			MIN	TYP	MAX.	
D33	Resolution	-			10	Bits
D34	Reference voltage Low level	V_{REFL_DA}		AV_{SS}		V
D35	Reference voltage High level	V_{REFH_DA}		AV_{DD50}		
D36	Integral non-linearity error	INLE			± 3	LSB
D37	Differential non-linearity error	DNLE			± 3	
D38	Zero-scale output voltage	V_{ZS}	D9 to D0 = ALL "L"	-20	20	mV
D39	Full-scale output voltage	V_{FS}	D9 to D0 = ALL "H"	4980	5020	
D40	Settling time	T_{daset}			8	μs
D41	Power supply current during operation (AVDD50 pin)	I_{DA}		0.04		mA/unit

Power supply voltage detection

$V_{SS} = AV_{SS} = 0.0\text{ V}$
 $T_a = -40\text{ }^\circ\text{C to } 125\text{ }^\circ\text{C}$

Parameter	Symbol	Conditions	Limits			Unit
			MIN	TYP	MAX	
D42	V_{LVI11}	At rising	2.70	2.90	3.10	V
D43		At falling	2.60	2.80	3.00	
D44	V_{LVI21}	At rising	3.60	3.80	4.00	
D45		At falling	3.50	3.70	3.90	
D46	V_{LVI31}	At rising	4.00	4.25	4.50	
D47		At falling	3.90	4.15	4.40	
D48	ΔV_{DD50}		0.2			ms/V

Auto-reset

$V_{SS} = AV_{SS} = 0.0\text{ V}$
 $T_a = -40\text{ }^\circ\text{C to } 125\text{ }^\circ\text{C}$

Parameter	Symbol	Conditions	Limits			Unit
			MIN	TYP	MAX	
D49	V_{RST1}	At rising	2.40	2.70	3.00	V
D50	V_{RST2}	At falling	2.30	2.45	2.60	
D51	ΔV_{DD50}		0.2			ms/V

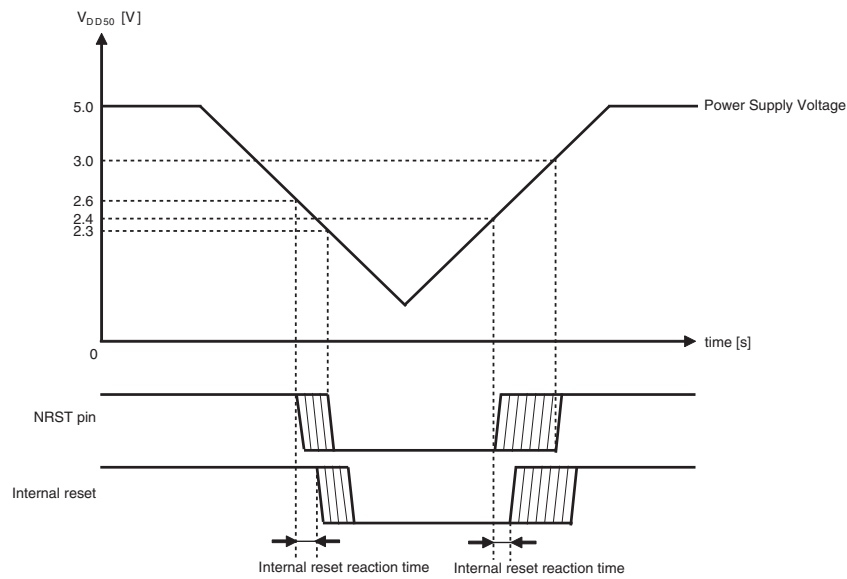

Figure:1.6.3 Auto-reset Characteristics

$V_{DD50} = AV_{DD50} = V_{RST}$ to 5.5 V

$V_{SS} = AV_{SS} = 0.0$ V

$T_a = -40$ °C to 125 °C

Internal low-speed oscillation

Parameter	Symbol	Conditions	Limits			Unit	
			MIN	TYP	MAX		
D52	Temperature dependence of frequency	F_{RCS}	Output frequency is 240 kHz	-10	0	10	%

$V_{DD50} = AV_{DD50} = V_{RST}$ to 5.5 V

$V_{SS} = AV_{SS} = 0.0$ V

$T_a = -40$ °C to 125 °C

MPLL

Parameter	Symbol	Conditions	Limits			Unit	
			MIN	TYP	MAX		
D53	Power supply current during MPLL operation	I_{MPLL}	Output frequency is 120 MHz		4		mA

1.6.5 AC Characteristics

Reset signal input timing

$V_{DD50} = AV_{DD50} = 5.0\text{ V}$
 $V_{SS} = AV_{SS} = 0.0\text{ V}$
 $T_a = -40\text{ }^\circ\text{C to } 125\text{ }^\circ\text{C}$

Parameter	Symbol	Conditions	Limits			Unit
			MIN	TYP	MAX	
E1	Reset signal pulse width (NRST)	t_{NRSTW}	1			μs

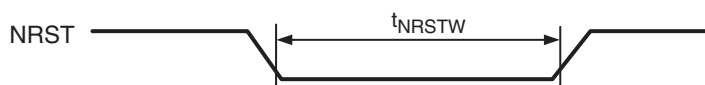

Figure:1.6.4 Reset signal pulse width

1.6.6 Flash EEPROM E/W Characteristics

$V_{SS} = AV_{SS} = 0.0\text{ V}$

Parameter	Symbol	Conditions	Limits			Unit
			MIN	TYP	MAX	
F1	Power supply voltage at E/W	V_{DD50EW}	2.7		5.5	V
F2	Ambient temperature at E/W	V_{OPREW}	-40		105	$^\circ\text{C}$
F3	Permissible rewriting times	E_{MAX1}	100			Times
F4	Permissible rewriting times	E_{MAX2}	10,000			Times
F5	Data retention time	T_{HOLD}	15			Years

1.7 Package Dimension

■ Package dimension of 144 pin LQFP

Figure:1.7.1 shows the package dimension of 144 pin LQFP.

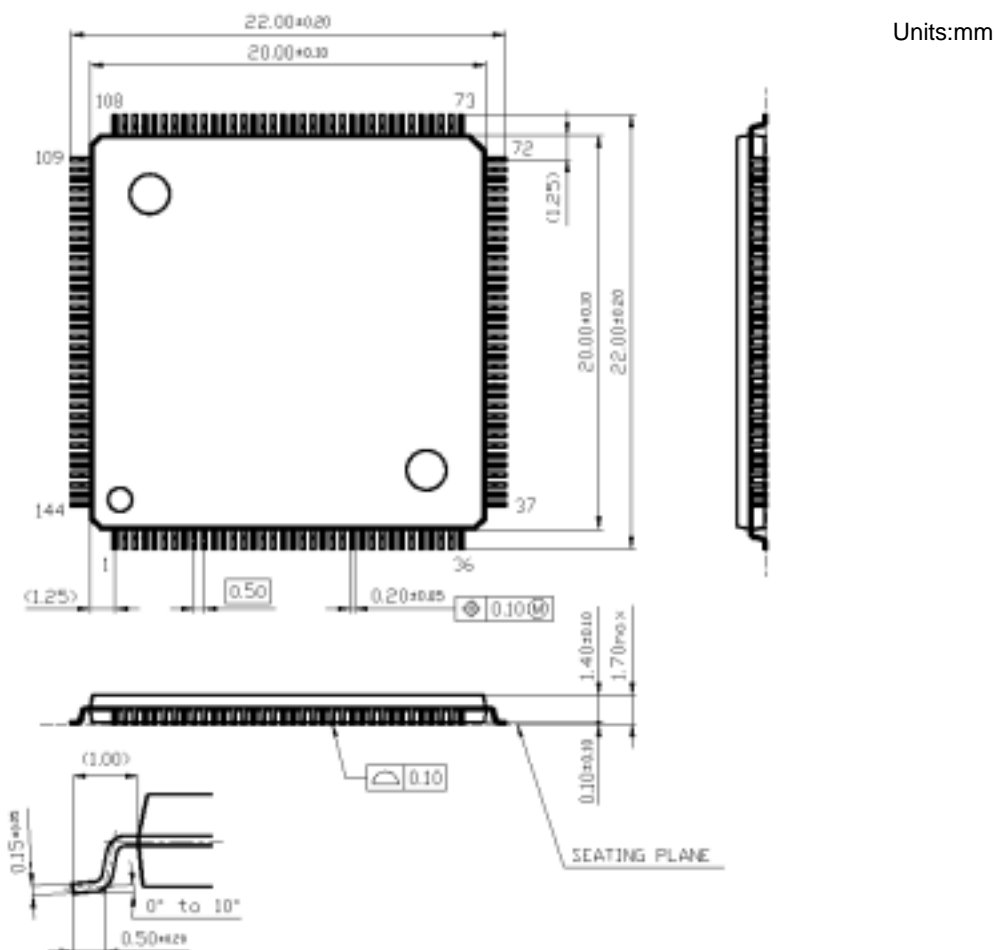

Figure:1.7.1 Package Dimension of 144 pin LQFP



The external dimensions of the package are subject to change. Before using this product, please obtain product specifications from the sales offices.

■ Package dimension of 128 pin LQFP

Figure:1.7.2 shows the package dimension of 128 pin LQFP.

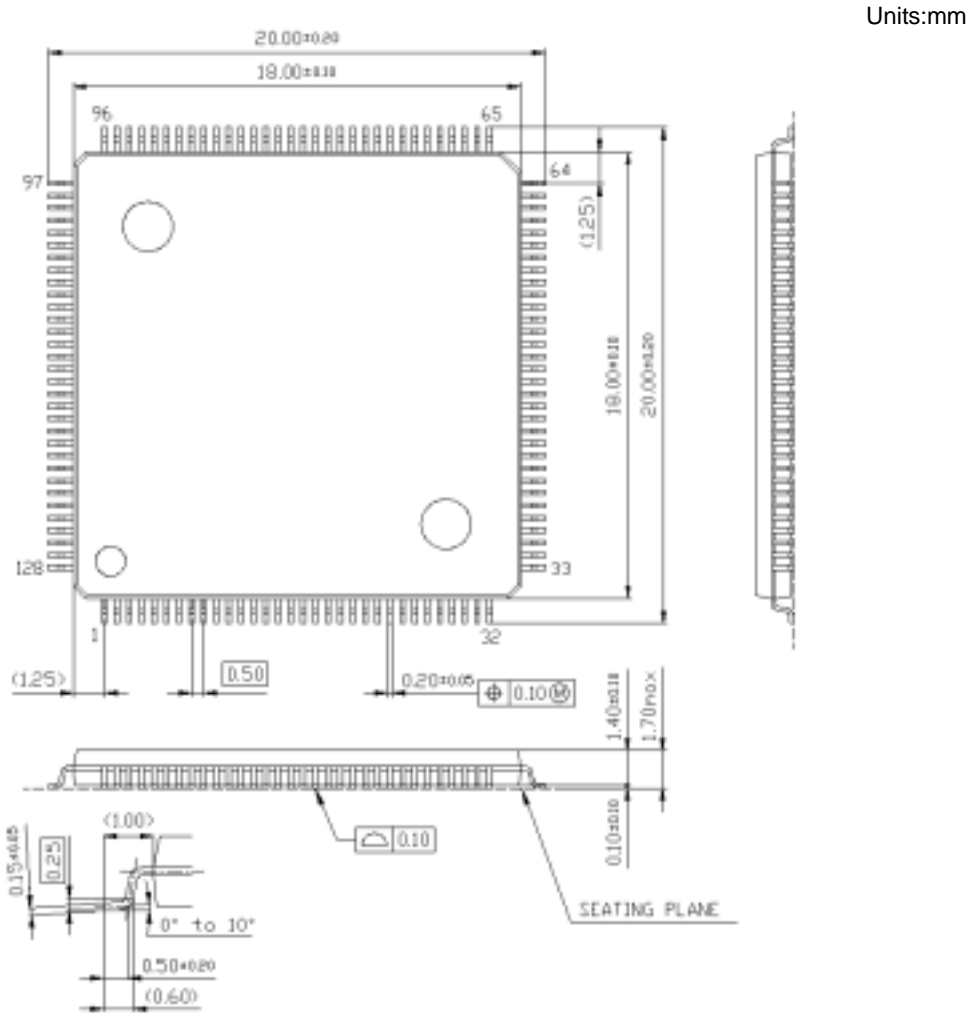

Figure:1.7.2 Package Dimension of 128 pin LQFP



The external dimensions of the package are subject to change. Before using this product, please obtain product specifications from the sales offices.

■ Package dimension of 100 pin LQFP

Figure:1.7.3 shows the package dimension of 100 pin LQFP.

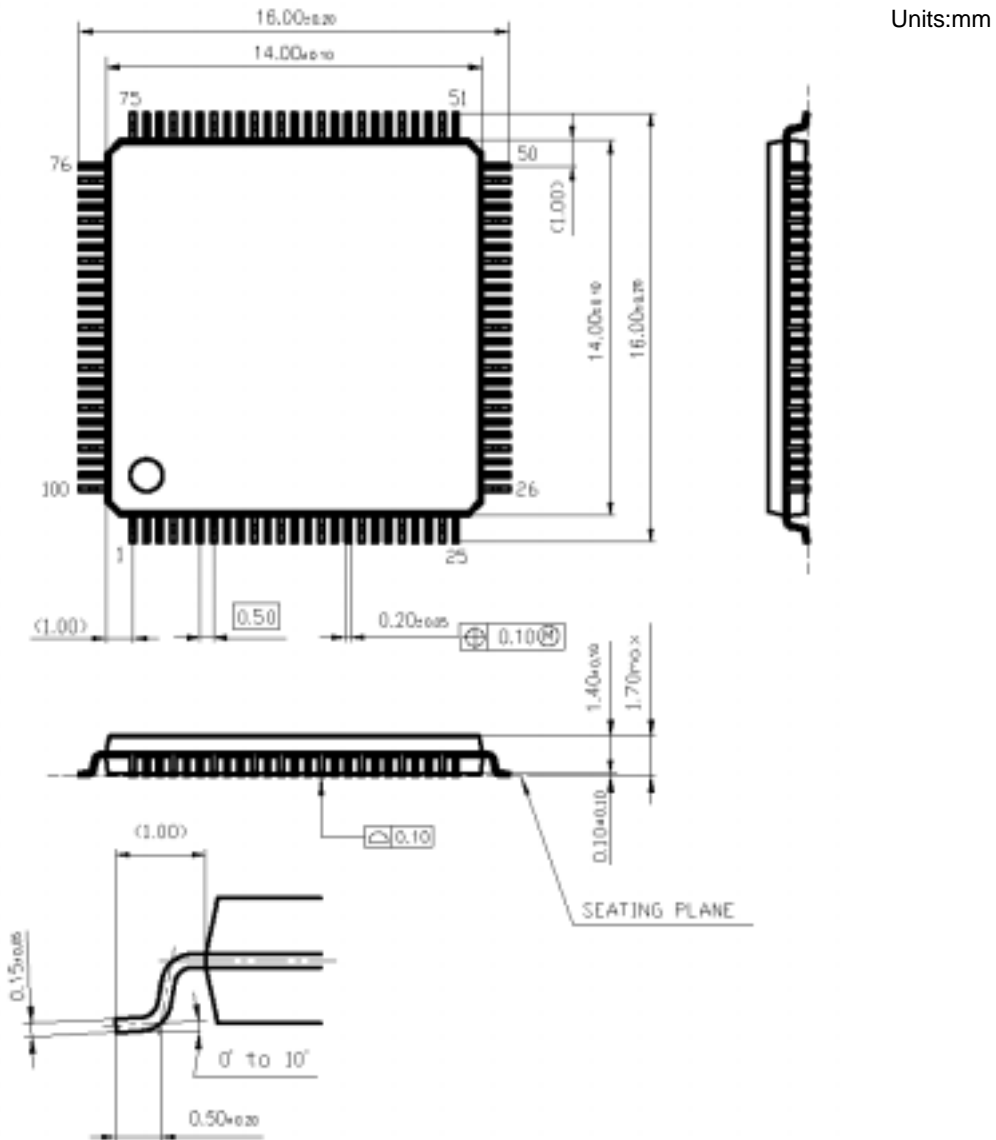

Figure:1.7.3 Package Dimension of 100 pin LQFP



The external dimensions of the package are subject to change. Before using this product, please obtain product specifications from the sales offices.

■ Package dimension of 80 pin TQFP

Figure:1.7.4 shows the package dimension of 80 pin TQFP.

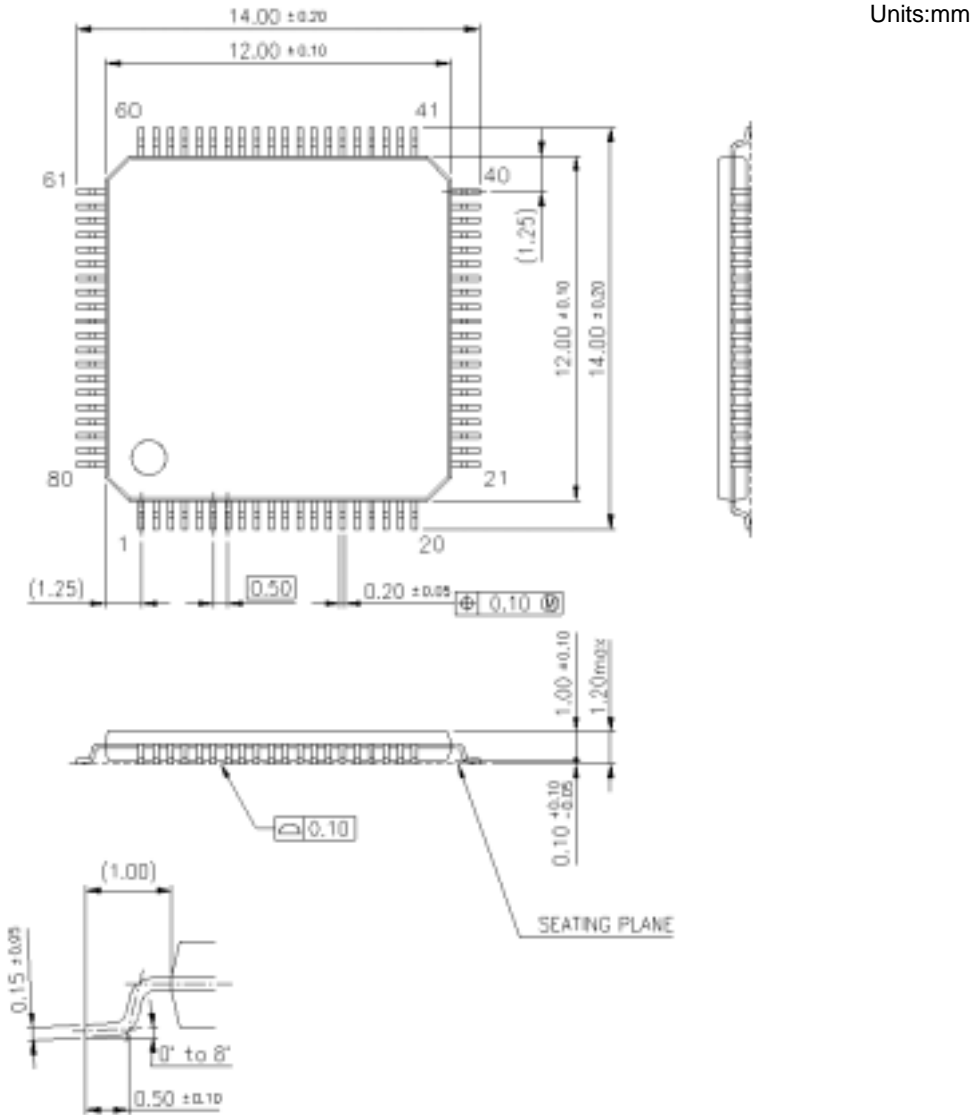

Figure:1.7.4 Package Dimension of 80 pin TQFP



The external dimensions of the package are subject to change. Before using this product, please obtain product specifications from the sales offices.

Request for your special attention and precautions in using the technical information and semiconductors described in this book

- (1) If any of the products or technical information described in this book is to be exported or provided to non-residents, the laws and regulations of the exporting country, especially, those with regard to security export control, must be observed.
- (2) The technical information described in this book is intended only to show the main characteristics and application circuit examples of the products. No license is granted in and to any intellectual property right or other right owned by Panasonic Corporation or any other company. Therefore, no responsibility is assumed by our company as to the infringement upon any such right owned by any other company which may arise as a result of the use of technical information de-scribed in this book.
- (3) The products described in this book are intended to be used for general applications (such as office equipment, communications equipment, measuring instruments and household appliances), or for specific applications as expressly stated in this book.
Please consult with our sales staff in advance for information on the following applications, moreover please exchange documents separately on terms of use etc.: Special applications (such as for in-vehicle equipment, airplanes, aerospace, automotive equipment, traffic signaling equipment, combustion equipment, medical equipment and safety devices) in which exceptional quality and reliability are required, or if the failure or malfunction of the products may directly jeopardize life or harm the human body.
Unless exchanging documents on terms of use etc. in advance, it is to be understood that our company shall not be held responsible for any damage incurred as a result of or in connection with your using the products described in this book for any special application.
- (4) The products and product specifications described in this book are subject to change without notice for modification and/or improvement. At the final stage of your design, purchasing, or use of the products, therefore, ask for the most up-to-date Product Standards in advance to make sure that the latest specifications satisfy your requirements.
- (5) When designing your equipment, comply with the range of absolute maximum rating and the guaranteed operating conditions (operating power supply voltage and operating environment etc.). Especially, please be careful not to exceed the range of absolute maximum rating on the transient state, such as power-on, power-off and mode-switching. Otherwise, we will not be liable for any defect which may arise later in your equipment.
Even when the products are used within the guaranteed values, take into the consideration of incidence of break down and failure mode, possible to occur to semiconductor products. Measures on the systems such as redundant design, arresting the spread of fire or preventing glitch are recommended in order to prevent physical injury, fire, social damages, for example, by using the products.
- (6) Comply with the instructions for use in order to prevent breakdown and characteristics change due to external factors (ESD, EOS, thermal stress and mechanical stress) at the time of handling, mounting or at customer's process. We do not guarantee quality for disassembled products or the product re-mounted after removing from the mounting board.
When using products for which damp-proof packing is required, satisfy the conditions, such as shelf life and the elapsed time since first opening the packages.
- (7) When reselling products described in this book to other companies without our permission and receiving any claim of request from the resale destination, please understand that customers will bear the burden.
- (8) This book may be not reprinted or reproduced whether wholly or partially, without the prior written permission of our company.