

TRIGGER DIODES

FEATURES

- * V_{BO} : 32V/34V/40V VERSIONS
- * Low Breakover Current

DESCRIPTION

High reliability glass passivation insuring parameter stability and protection against junction contamination



LL-34

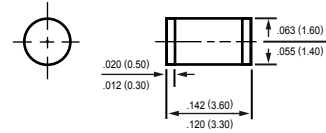

Dimensions in inches and (millimeters)

MAXIMUM RATINGS AND ELECTRICAL CHARACTERISTICS

Ratings at 25 °C ambient temperature unless otherwise specified.
Single phase, half wave, 60 Hz, resistive or inductive load.
For capacitive load, derate current by 20%.

MAXIMUM RATINGS (At $T_A = 25^\circ\text{C}$ unless otherwise noted)

RATING	SYMBOL	VALUE	UNITS
Repetitive Peak On-State Current $t_p=20\mu\text{s}, F=100\text{Hz}$	I_{TRM}	2	A
Power Dissipation (@ $T_A=50^\circ\text{C}$) Derate Above $+50^\circ\text{C}$	P	150	mW
		4.0	mW/ $^\circ\text{C}$
Storage Temperature Range	T_{STG}	-40 to + 125	$^\circ\text{C}$
Junction Temperature	T_J	125	$^\circ\text{C}$

ELECTRICAL CHARACTERISTICS (At $T_A = 25^\circ\text{C}$ unless otherwise noted)

RATING	SYMBOL	VALUE				UNITS
		LLDB3SEL		LLDB3		
Breakover Voltage(Forward and Reverse) at $I_{BO}, C=22\text{nF}^{**}$	V_{BO}	Min 30	Max 34	Min 28	Max 36	Volts
Maximum Breakover Voltage Symmetry $\Delta V_{BO} = V_{BO+} - V_{BO-} $ C=22nF	ΔV_{BO}	+/-2				Volts
Minimum Dynamic Breakover Voltage $\Delta I = I_{BO}$ to $I_F=10\text{mA}$ (see Fig3)	$ \Delta V_{+/-} $	5				Volts
Minimum Output Voltage* (see Fig 2)	V_O	5				Volts
Peak Breakover Current at Breakover Voltage* C=22nF**	I_{BO}	25		100		μA
Rise Time* (see Fig3)	t_r	1.5				μs
Leakage Current* $V_B=0.5V_{BO}$ max (see Fig1)	I_B	10				μA

NOTES: 1. *Electrical characteristic applicable in both forward and reverse directions.

2008-02

2.**Connected in parallel with the devices.

3. "Fully ROHS compliant", "100% Sn plating (Pb-free)".

RATING AND CHARACTERISTICS CURVES (LLDB3 AND LLDB3SEL)

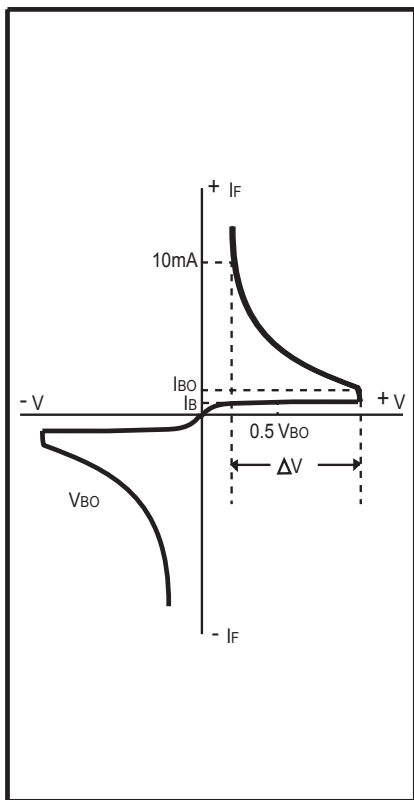

FIG.1 Current-voltage characteristics

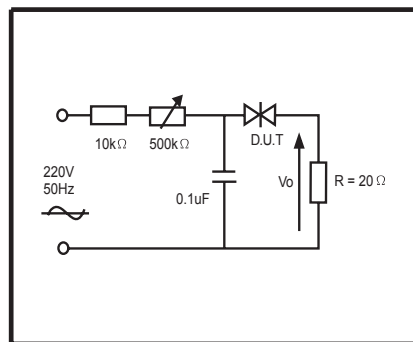

FIG.2 Test circuit for output voltage

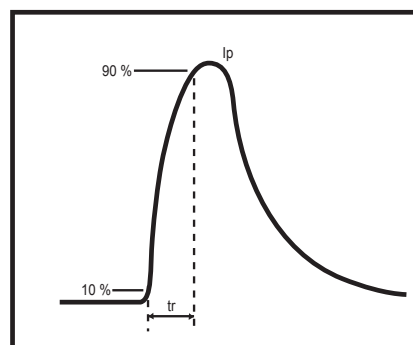

FIG.3 Test circuit see Fig.2
Adjust R for $I_p=0.5\text{A}$

RATING AND CHARACTERISTICS CURVES (LLDB3 AND LLDB3SEL)

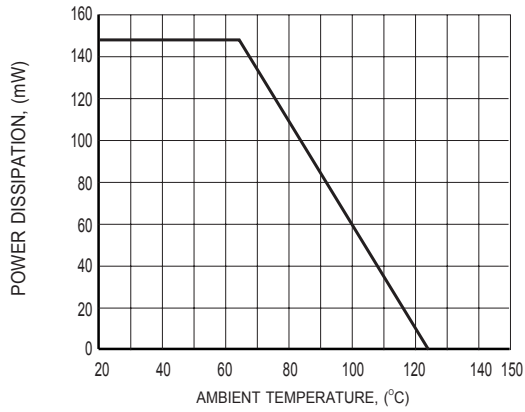

FIG.4 POWER DISSIPATION VERSUS AMBIENT TEMPERATURE (MAXIMUM VALUES)

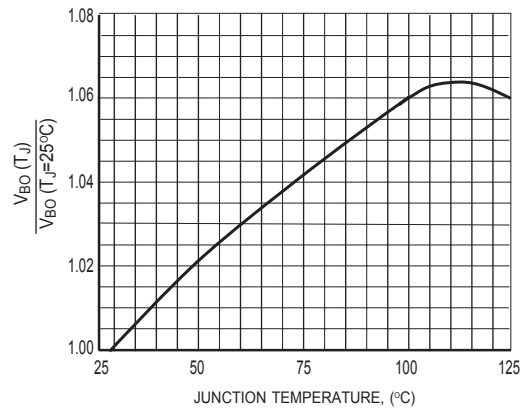

FIG.5 RELATIVE VARIATION OF V_{BO} VERSUS JUNCTION TEMPERATURE (TYPICAL VALUES)

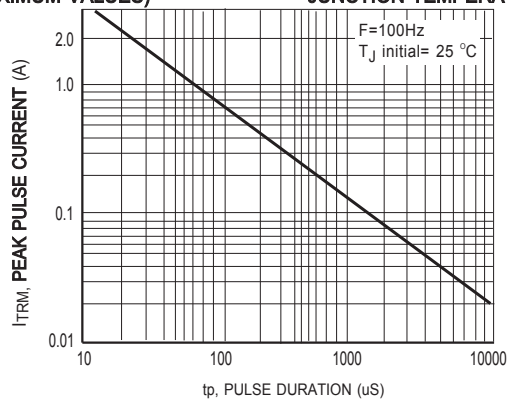

FIG.6 PEAK PULSE CURRENT VERSUS PULSE DURATION (MAXIMUM VALUES)

DISCLAIMER NOTICE

Rectron Inc reserves the right to make changes without notice to any product specification herein, to make corrections, modifications, enhancements or other changes. Rectron Inc or anyone on its behalf assumes no responsibility or liability for any errors or inaccuracies. Data sheet specifications and its information contained are intended to provide a product description only. "Typical" parameters which may be included on RECTRON data sheets and/ or specifications can and do vary in different applications and actual performance may vary over time. Rectron Inc does not assume any liability arising out of the application or use of any product or circuit.

Rectron products are not designed, intended or authorized for use in medical, life-saving implant or other applications intended for life-sustaining or other related applications where a failure or malfunction of component or circuitry may directly or indirectly cause injury or threaten a life without expressed written approval of Rectron Inc. Customers using or selling Rectron components for use in such applications do so at their own risk and shall agree to fully indemnify Rectron Inc and its subsidiaries harmless against all claims, damages and expenditures.