

Pulse switching (20 pulses) model available in same shape

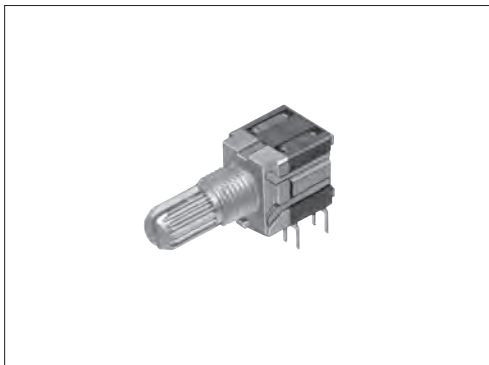

### Typical Specifications

Items		Specifications	
		Rotary switch	Pulse switch
Rating (max.)/(min.) (Resistive load)		0.1A 16V DC / 50μA 3V DC	
Contact resistance (Initial / After operating life)		50mΩ max. / 150mΩ max.	
Rotational torque		40±20 mN·m	15±7 mN·m
Operating life	Without load	10,000 cycles	30,000 cycles
	With load	10,000 cycles (0.1A 16V DC)	

### Product Line

Number of wafers	Poles	Positions	Changeover angle	Changeover timing	Actuator configuration	Actuator length (mm)	Minimum order unit (pcs.)		Product No.	Drawing No.
							Japan	Export		
1	2	2	30±3°	Non shorting	18-tooth serration	L=15	360	1,800	<b>SRBM120700</b>	1
					Flat				<b>SRBM121300</b>	
		3			18-tooth serration	L=20	210	1,050	<b>SRBM131300</b>	
					Flat	L=15	360	1,800	<b>SRBM131400</b>	
		4			18-tooth serration	L=20	210	1,050	<b>SRBM140700</b>	
					Flat	L=15	360	1,800	<b>SRBM140800</b>	
	1	5	18-tooth serration	L=15	360	1,800	<b>SRBM150500</b>			
			Flat				<b>SRBM154002</b>			
		6	18-tooth serration	L=15	360	1,800	<b>SRBM160700</b>			
			Flat				<b>SRBM1L0800</b>			
20 pulses	18±3°	—	18-tooth serration	L=15	360	1,800	<b>SRBM1L0800</b>	2		
			Flat				<b>SRBM1L1400</b>			

### Note

All the axis are die casting shafts.

### Packing Specifications

Tray

Product No.	Number of packages (pcs.)		Export package measurements (mm)
	1 case / Japan	1 case / export packing	
<b>SRBM120700</b> <b>SRBM121300</b> <b>SRBM131300</b> <b>SRBM140700</b> <b>SRBM150500</b> <b>SRBM154002</b> <b>SRBM160700</b> <b>SRBM1L0800</b> <b>SRBM1L1400</b>	360	1,800	400×270×290
<b>SRBM131400</b> <b>SRBM140800</b> <b>SRBM149501</b>	210	1,050	

Refer to P.139 for shaft configurations.  
Refer to P.145 for soldering conditions.

# SRBM 6-position Horizontal Type

Detector

Slide

Push

Rotary

Power

Dual-in-line  
Package Type

## Dimensions Single-shaft Type

Unit:mm

No.	Style	PC board mounting hole dimensions (Viewed from direction A)
1	<b>Rotary switch</b> 	
2	<b>Pulse switch</b> 	

## Pulse Switch Circuit Diagram

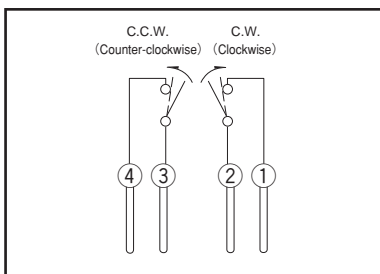

C.W. : ①② ON during changeover only  
 C.C.W. : ③④ ON during changeover only

## Rotary Switch Circuit Diagram (Viewed from Direction A of Below Diagram)

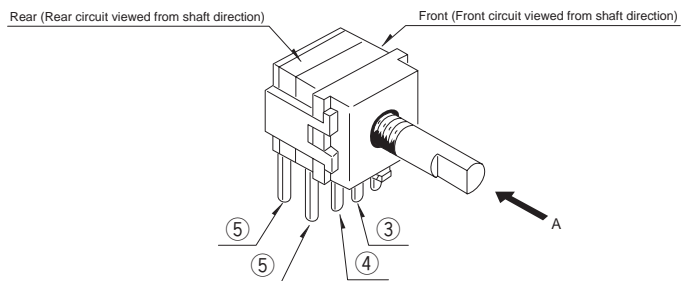

2 to 4-position		5-position ※ 1		6-position ※ 2	
Rear	Front	Rear	Front	Rear	Front

## Notes

- For position 2 to 4, 1 section consists of 2-pole.
- For position 5 and 6, 1 section consists of 1-pole.
  - ※ 1: Circuit steps are position 2 to 5 at front and position 1 to 4 at rear. (External wiring to common terminal is required.)
  - ※ 2: Circuit steps are position 3 to 6 at front and position 1 to 4 at rear. (External wiring to common terminal is required.)

Detector  
Slide  
Push  
Rotary  
Power  
Dual-line Package Type

**Dummy Terminals**

Number of positions	2	3	4	5	6
Front	④ ⑤	⑤	—	—	—
Rear	③ ④	④	—	—	—

**18-tooth Serration Shaft**

The shaft shows the position in which it is turned fully counterclockwise.

Die Casting Shaft

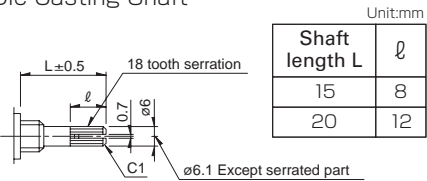

Unit:mm	
Shaft length L	φ
15	8
20	12

Details About Serration

- (1) The mold dimensions of standard serration and the dimensions of test jigs are as shown in the figure at left.
- (2) Position of the serration bottom  
When the shaft is turned fully counterclockwise, the position of the serration bottom is on the AA line.
- (3) Slitting angle  
The slitting angle (position) is not specified.

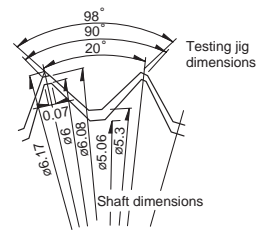

**Flat Shaft**

The shaft shows the position in which it is turned fully counterclockwise.

Die Casting Shaft

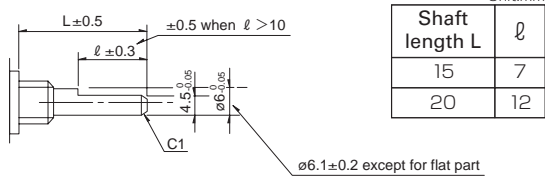

Unit:mm	
Shaft length L	φ
15	7
20	12

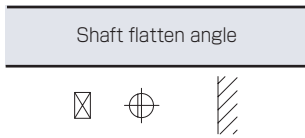

**Note**





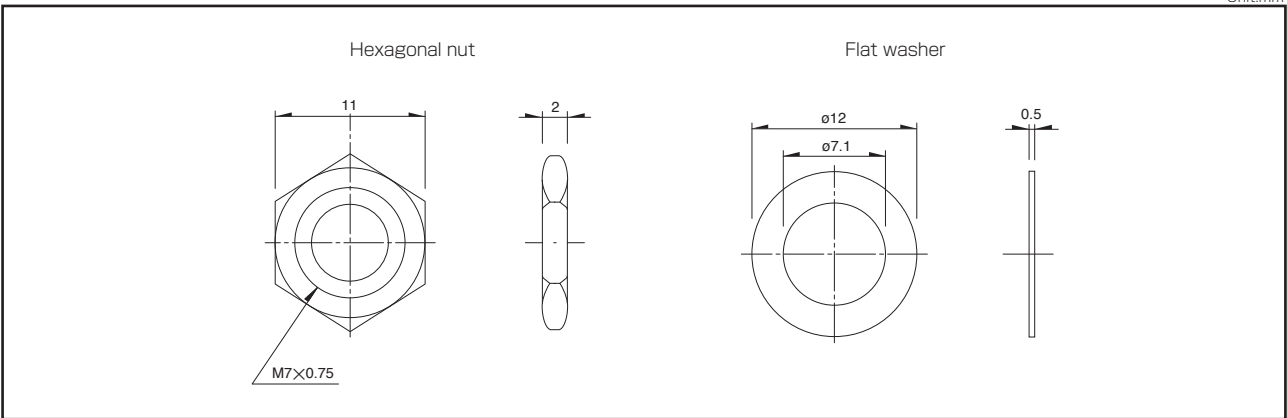





Please be aware that shaft flatten angle is based on (PCB terminal direction)

**Attached Parts**



# Rotary Switches

## List of Varieties

Series	SRBD	SRBQ		SRBM		SRBV	SRRM		
		Insertion	Reflow type	Rotary	Pulse				
Photo									
Angle of throw	36°	40±3°		30±3°	18±3°	30±3°			
Number of poles	1		1, 2		1	1, 2, 3, 4			
Rotational torque	13±5mN·m	6±3mN·m 13±5mN·m		40±20mN·m 15±7mN·m		30±15mN·m	80±30mN·m (Shorting) 70±30mN·m (Non shorting)		
Dimensions (mm)	W	10		10		16.2	—		
	D	11.4		12.5		18.5			
	H	12.4		11		7.5			
Operating temperature range	-25°C to +85°C	-10°C to +60°C		-30°C to +85°C		-10°C to +85°C	-10°C to +60°C		
Automotive use	—	—		—		—	—		
Life cycle									
Rating (max.)/(min.) (Resistive load)	1mA 5V DC 50µA 3V DC	0.1A 16V DC 50µA 3V DC				0.3A 16V DC 50µA 3V DC	0.25A 30V DC 50µA 3V DC		
Durability	Operating life without load	10,000 cycles 250mΩ max.	10,000 cycles 100mΩ max.		30,000 cycles 100mΩ max.	10,000 cycles 100mΩ max.	10,000 cycles 40mΩ max.		
	Operating life with load Load: as rating	10,000 cycles 250mΩ max.	10,000 cycles 100mΩ max.	10,000 cycles 150mΩ max.		10,000 cycles 60mΩ max.	10,000 cycles 60mΩ max.		
Electrical performance	Initial contact resistance	200mΩ max.	50mΩ max.				20mΩ max.		
	Insulation resistance	100MΩ min. 100V DC					100MΩ min. 500V DC		
	Voltage proof	100V AC for 1minute					500V AC for 1minute		
Mechanical performance	Terminal strength	3N for 1minute	5N for 1minute				10N for 1minute		
	Actuator strength	Operating direction	—	—	0.5N·m	—	0.6N·m	1N·m	
		Pulling direction	50N	20N	100N				
	Wobble of actuator	Load at the tip of shaft SRRM, SRBM, SRBQ, SRBV: 1N							
The below table shows for SRRM, SRBM			The below table shows for SRBQ		The below table shows for SRBV				
		Measuring position from mounting surface	Shaft wobble (max. value)	Applicable mounting dimension	Distance from mounting surface to the tip of shaft	Shaft wobble (max. value)	Measuring position from mounting surface	Shaft wobble (max. value)	Applicable mounting dimension
		10	0.17	15	below 5	0.5	10	0.2	15
		15	0.25	20	above 5 and below 10	0.9	15	0.3	20
		20	0.35	25	above 10 and below 15	1.2	20	0.4	25
		25	0.42	30					
		30	0.5	above 35					
Unit:mm									
Environmental performance	Cold	-40°C 500h	-20°C 96h	-40°C 96h	-20°C 96h				
	Dry heat	85°C 500h	85°C 96h						
	Damp heat	60°C, 90 to 95%RH 500h	40°C, 90 to 95%RH 96h						
Page	133	135	137	140	142				

Rotary Switches Soldering Conditions	145
Rotary Switches Cautions	146

## Example of Reflow Soldering Condition

1. Heating method: Double heating method with infrared heater.
2. Temperature measurement: Thermocouple  $\phi 0.1$  to  $0.2$  CA (K) or CC (T) at soldering portion (copper foil surface).  
A heat resisting tape should be used for fixed measurement.
3. Temperature profile

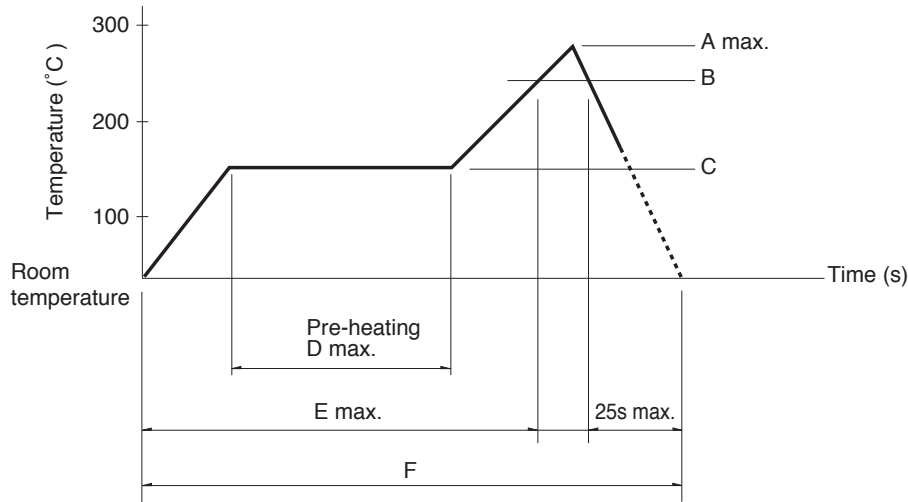

Series (Reflow type)	A (°C) 3s max.	B (°C)	C (°C)	D (s)	E (s)	F (s)
<b>SRBQ</b>	250	200	150±5	80 to 100	—	—

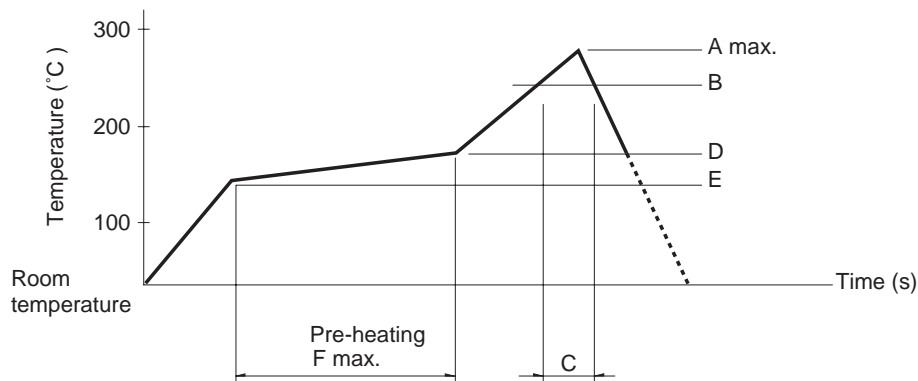

Series (Reflow type)	A (°C) 3s max.	B (°C)	C (s)	D (°C)	E (°C)	F (s)
<b>SRBD</b>	260	230	40	180	150	120

- Notes**
1. The condition mentioned above is the temperature on the mounting surface of a PC board. There are cases where the PC board's temperature greatly differs from that of the switch, depending on the PC board's material, size, thickness, etc. The above-stated conditions shall also apply to switch surface temperatures.
  2. Soldering conditions differ depending on reflow soldering machines. Prior verification of soldering condition is highly recommended.

## Reference for Hand Soldering

Series	Soldering temperature	Soldering time
<b>SRBQ, SRBM, SRBV, SRRM</b>	350±10°C	3+1/0s
<b>SRBQ (Reflow type)</b>	350±5°C	3s max.

## Reference for Dip Soldering

(For PC board terminal types)

Series	Items		Dip soldering	
	Preheating temperature	Preheating time	Soldering temperature	Duration of immersion
<b>SRBM</b>	100°C max.	60s max.	260±5°C	5s max.
<b>SRBV, SRRM</b>	—	—	260±5°C	10±1s
<b>SRBQ</b>	—	—	260±5°C	5±1s

# Mouser Electronics

Authorized Distributor

Click to View Pricing, Inventory, Delivery & Lifecycle Information:

[Alps Alpine:](#)

[SRBM120700](#) [SRBM121300](#) [SRBM131400](#) [SRBM140700](#) [SRBM149501](#) [SRBM154002](#) [SRBM1L1400](#)  
[SRBM160700](#) [SRBM1L0800](#) [SRBM131300](#) [SRBM140800](#) [SRBM150500](#)