

Piezo Switch N.O.



Alu natural  
Non-illuminated



Gold  
Non-illuminated



PSE 16

See below:

[Approvals and Compliances](#)

**Description**

- Available in version Standard and lettered
- Assembly by mounting with nut
- Easy to clean due to a tightly closed surface (IP69K)
- Pins / Wire / Faston

**Unique Selling Proposition**

- Variety of design options regarding size, colour, shape, connection or lettering
- High reliability, long lifetime with more than 20 mill. actuations

**Characteristics**

- Housing material types: plastic, aluminum or stainless steel, ring illuminated version additionally made of polyamide
- For use in harsh environments, both indoors and outdoors (see technical data)

**Other versions on request**

- Switch for longer switching signal duration, type: PSE IV
- Switch for explosion proof applications, type: PSE EX
- Switch with enhanced vandal proof protection, type: PSE HI

**References**

- Alternative: switch vandal improved: [PSE HI 22](#)
- Alternative: switch for EX-proof applications:
- Alternative: Other diameter
- Alternative: Other diameter [PSE with cable](#); [PSE NO 19](#); [PSE NO 22](#)
- Alternative: switch with prolonged signal: [PSE AE 16](#); [PSE AE 30](#); [PSE IV 19](#)

**Weblinks**

- [pdf data sheet](#), [html datasheet](#), [General Product Information](#), [CAD-Drawings](#), [Product News](#), [Detailed request for product](#)

**Technical Data**

**Electrical Data**

Switching Function	momentary
Switching Voltage	max. 42 / 60 VAC/DC
Switching Current	max. 100 mA
Electrical Rating	1 W
Lifetime	20 million actuations at Rated Switching Capacity
Switch Resistance OFF	> 10 MΩ
Switch Resistance ON	< 20 Ω actuated (Ta = 25°C)
Capacity	5 nF
N.O. Closing Impulse Duration	20- 1000 ms depending on actuating force, time and speed
Contact Configuration	free polarity

**RGB Illumination**

Current Consumption (max per color) -

**Mechanical Data**

Actuating Force	≤ 3 N at ambient temperature
Actuating Travel	0.002 mm
Shock Protection	IK02
Mounting screw torque	2.5 Nm

**Climatical Data**

Operating Temperature	-40 to 85 °C
Storage Temperature	-40 to 85 °C
IP-Protection	IP67 acc. to IEC 60529, IP69K acc. to DIN 40050-9
Environmental Assessment	+55°C / 93% r.h. acc. to DIN EN 60068-2-30
Salt Spray Test (acc. to DIN 50021-SS)	24 h / 48 h / 96 h Residence Time

**Material**

Housing (depending on type)	Stainless Steel, Aluminium anodized, Polyamide
Actuating Area / Insert (with Ring Illumination)	Stainless Steel, Aluminum anodized
Illuminated Ring (Ring Illumination)	Polyamide



**Approvals and Compliances**

Detailed information on product approvals, code requirements, usage instructions and detailed test conditions can be looked up in [Details about Approvals](#)

SCHURTER products are designed for use in industrial environments. They have approvals from independent testing bodies according to national and international standards. Products with specific characteristics and requirements such as required in the automotive sector according to IATF 16949, medical technology according to ISO 13485 or in the aerospace industry can be offered exclusively with customer-specific, individual agreements by SCHURTER.





## Application standards

Application standards where the product can be used

Organization	Design	Standard	Description
	Designed for applications acc.	EMC Directive:	EMC directive 2014/30/EU
	Designed for applications acc.	MIL-STD:	202F Method 107G, 202F Method 204D, 202F Method 213B, 416D Method RS103, 810E Method 501.3, 810E Method 502.3, 810E Method 507.3
<b>VDE</b>	Designed for applications acc.	VDE Certificate Number:	DIN EN 61000-4-2, DIN EN 61000-4-4, DIN EN 61000-4-5
	Designed for applications acc.	IEC/UL 62368-1	Audio/video, information and communication technology equipment - Part 1: Safety requirements

## Compliances

The product complies with following Guide Lines

Identification	Details	Initiator	Description
	<a href="#">CE declaration of conformity</a>	SCHURTER AG	The CE marking declares that the product complies with the applicable requirements laid down in the harmonisation of Community legislation on its affixing in accordance with EU Regulation 765/2008.
	<a href="#">UKCA declaration of conformity</a>	SCHURTER AG	The UKCA marking declares that the product complies with the applicable requirements laid down in the British Amendment of Regulation (EC) 765/2008.
	RoHS	SCHURTER AG	Directive RoHS 2011/65/EU, Amendment (EU) 2015/863
	REACH	SCHURTER AG	On 1 June 2007, Regulation (EC) No 1907/2006 on the Registration, Evaluation, Authorization and Restriction of Chemicals 1 (abbreviated as "REACH") entered into force.

## Dimension [mm]

PSE 16 with Pins

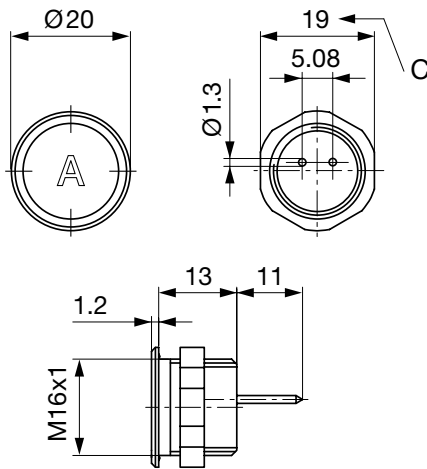

PSE M16 with Faston

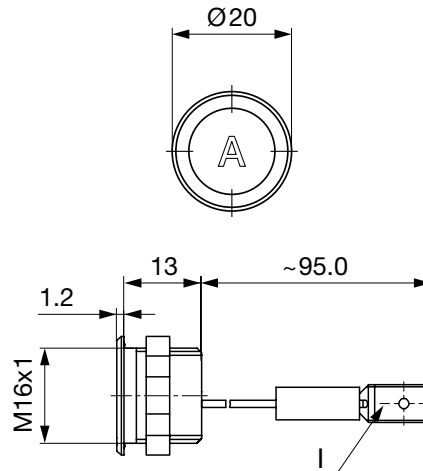

PSE M16 with stranded wire

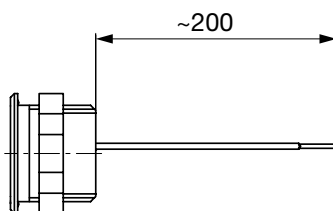

Design actuating area

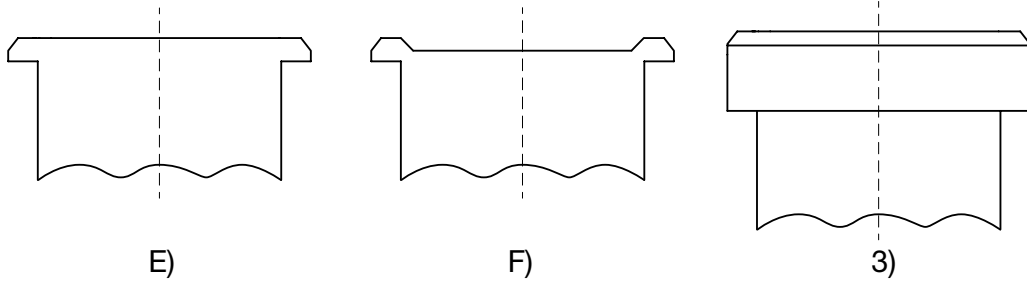

Legende:  
 C = Schlüsselweite  
 l = Flachsteckzunge 6,3 x 0,8

Beschriftung:  
 - wahlweise mit/ohne Beschriftung  
 - Lage der Anschlüsse zur Lage der Beschriftung ist nicht definiert

F) mit Fingerführung  
 E) ohne Fingerführung  
 3) erhöhte Frontform M19 (Standard, weitere auf Anfrage)

Dimension

PSE 16

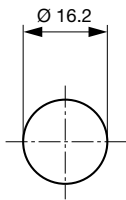

Drilling diagram

Marking

The last three digits in the order number define the lettering:

001-076	Standard Lettering
101-	Customized Lettering

Lettering - Aluminium / Plastic Material

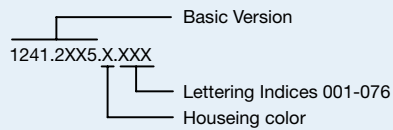

Lettering - Stainless Steel

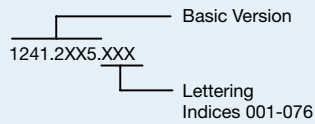

Lettering Colour of Laser Lettering

Material	Lettering Colour	
Stainless Steel	black	Filled letters
Aluminum natural anodized	light grey	Filled letters (only after customer approval)
Aluminum coloured anodized	light grey	Filled letters

**Order Index Lettering**

Laser Marking			
001 =A	021 =U	041 =÷	061 =EIN
002 =B	022 =V	042 = *	062 =AUS
003 =C	023 =W	043 ==	063 =AUF
004 =D	024 =X	044 = #	064 =AB
005 =E	025 =Y	045 = ↔	065 =ON
006 =F	026 =Z	046 = †	066 =OFF
007 =G	027 =0	047 = →	067 =UP
008 =H	028 =1	048 = ←	068 =DOWN
009 =I	029 =2	049 = ↓	069 =HIGH
010 =J	030 =3	050 = ↑	070 =LOW
011 =K	031 =4	051 = %	071 =ON/OFF
012 =L	032 =5	052 = √	072 =START
013 =M	033 =6	053 =CTRL	073 =RESET
014 =N	034 =7	054 =RETURN	074 =🔌
015 =O	035 =8	055 =SHIFT	075 =💡
016 =P	036 =9	056 =LOCK	076 =🔔
017 =Q	037 =+	057 =STOP	077 =Ⓜ
018 =R	038 =-	058 =ENTER	
019 =S	039 =.	059 =BACK	
020 =T	040 = x	060 =LINE	

Please note that the font size depends on the number of characters

**All Variants**

Mounting Diameter	Terminal	Housing Material, Torsion Protection	Colour of Housing	Actuator area	Illumination, LED	Config. Code	Order Number
16	Faston	Aluminum ,no	red	F	non-illuminated	PSE M 16 NO Alu/St	1241.3000
16	Faston	Aluminum ,no	green	F	non-illuminated	PSE M 16 NO Alu/St	1241.3001
16	Faston	Aluminum ,no	black	F	non-illuminated	PSE M 16 NO Alu/St	1241.3002
16	Faston	Aluminum ,no	Alu natural	F	non-illuminated	PSE M 16 NO Alu/St	1241.3003
16	Faston	Plastics ,no	Alu natural	F	non-illuminated	PSE M 16 NO K	1241.2356
16	Flexible wire connection	Aluminum ,no	gold	F	non-illuminated	PSE M 16 NO Alu/St	1241.3336.075
16	Pins	Aluminum ,no	gold	F	non-illuminated	PSE M 16 NO Alu/St	1241.2411.1
16	Pins	Aluminum ,no	red	F	non-illuminated	PSE M 16 NO Alu/St	1241.2411.3
16	Pins	Aluminum ,no	blue	F	non-illuminated	PSE M 16 NO Alu/St	1241.2411.4
16	Pins	Aluminum ,no	green	F	non-illuminated	PSE M 16 NO Alu/St	1241.2411.5
16	Pins	Aluminum ,no	black	F	non-illuminated	PSE M 16 NO Alu/St	1241.2411.7
16	Pins	Aluminum ,no	Alu natural	F	non-illuminated	PSE M 16 NO Alu/St	1241.2411.8
16	Pins	Plastics ,no	red	F	non-illuminated	PSE M 16 NO K	1241.2350
16	Pins	Plastics ,no	white	F	non-illuminated	PSE M 16 NO K	1241.2351
16	Pins	Plastics ,no	Alu natural	F	non-illuminated	PSE M 16 NO K	1241.2352
16	Pins	Plastics ,no	black	F	non-illuminated	PSE M 16 NO K	1241.2353
16	Pins	Stainless Steel ,no	-	F	non-illuminated	PSE M 16 NO Alu/St	1241.2611

Nut with gasket are enclosed in the box.

Other mounting diameters, materials, colors, connections, supply voltages possible available on request. Special materials e.g. Marine grade stainless steel for use in salt and chlorinated environment on request.

The MOQ for standard laser lettering on standard variants is a packing unit.

Most Popular.

Availability for all products can be searched real-time:<https://www.schurter.com/en/Stock-Check/Stock-Check-SCHURTER>

Mounting Diameter	Terminal	Housing Material, Torsion Protection	Colour of Housing	Actuator area	Illumination, LED	Config. Code	Order Number
Legend:							
Type: PSE							
NO = normaly open							
K = Plastics							
Alu = Aluminium							
ES = Stainless steel							
F = Finger guidance							

**Packaging unit** 10 in box with insert or packed in air cushion bags



- Actuating elements in ESD safe packaging
- Screw nuts and sealing O-ring in a bag (enclosed in the box)

**Accessories**

Description



Connecting Terminal PSE  
 Connecting Terminal