



COAXIAL SOLID-STATE

High Power Amplifier ZHL-2425-250X+

50Ω 250W 2.4 to 2.5 GHz

THE BIG DEAL

- High output power, 300W
- 2.4 to 2.5GHz ISM band
- Suitable for CW and pulsed signals
- High gain, 42 dB typical
- High efficiency, 60%
- High ruggedness
- Built-in monitoring and protection for temperature, current forward and reflected power
- User friendly I2C control interface



Generic photo used for illustration purposes only

Model No.	ZHL-2425-250X+
Case Style	VU3193
Connectors	MCX & N-Type

+RoHS Compliant

The +Suffix identifies RoHS Compliance. See our website for methodologies and qualifications

PRODUCT OVERVIEW

The ZHL-2425-250X+ is a new generation solid state connectorized high-power amplifier module which can be used in a wide range of industrial, scientific and medical (ISM) applications in the 2400-2500 MHz ISM band. The ZHL-2425-250X+ provides many advantages over traditional magnetrons, such as longer lifespan, accurate frequency tuning, better frequency stability, precise control of output power, and lower power supply voltage. This rugged amplifier is capable of amplifying signals (CW & pulsed) from 1W to 300W output power with built-in monitoring and protection for temperature, current, supply voltage, forward power, and reverse power.

The amplifier has internal shutdown circuitry and integrated protection functions for added reliability under difficult operating conditions, making it virtually impossible to destroy both in single and multi-channel systems. The basic amplifier can be controlled externally with a few logic inputs or through a user friendly I2C control interface to monitor forward and reflected power to support dynamic load analysis, temperature, current, shutdown alarms, enabling the PA, and for resetting protection alarms. For advanced mode, users may consult the factory for more in-depth amplifier control commands, access to FWD/REFL power coefficients, and protection overrides.

KEY FEATURES

Feature	Advantages
High CW Power	Supports high power applications for a wide range of industrial, scientific and medical applications in the 2400 – 2500 MHz ISM frequency band. Power can be regulated accurately from 1W up to 300W (~P3dB, @+25C).
High Gain	A typical gain of 42 dB allows the ZHL-2425-250+ to be driven to full output power with commercially available integrated signal generators with a 14dBm output signal.
High Efficiency	The ZHL-2425-250+ uses high efficiency state of the art LDMOS technology. This combined with adaptive frequency control enables a high efficiency of typically 60% in most applications.
Built-in protection	The amplifier has built-in monitoring and protection for temperature, current, voltage, forward power, reverse power, and internal shutdown circuitry for added reliability under difficult operating conditions. When the prestored limits shown in the protection limits table are exceeded the amplifier will shut down.
Ruggedness	The amplifier has excellent reverse isolation and ruggedness with an onboard circulator. Reverse power is monitored, and the amplifier is shut down when the reverse power exceeds the prestored limits shown in the protection limits table.
Forward & Reverse Power detection	The amplifier features integrated couplers and detectors for Forward (FWD) and Reflected (REFL) power detection. FWD and REFL power detection supports accurate RF power measurements as well as dynamic load analysis and can be used to control or shut-off the amplifier by using the internal monitoring or an external controller.
Easy interfacing	Easy access to the amplifiers analog and digital (I2C) data, enabling dynamic ISM applications with either single or multiple modules to be controlled.
Small and lightweight	With a small footprint (55.9mm x 171.5mm x 15mm) the lightweight (0.29 kg) modular design is flexible for single or multiple amplifier system integration.
Cooling	The amplifier can either be air or water cooled. Mounting screw holes are available on the amplifier.
Low voltage	The ZHL-2425-250+ is powered by a low voltage 32V supply.

**ELECTRICAL SPECIFICATIONS AT +25°C, 32V, 50Ω SYSTEM, 3.3V LOGIC LEVELS**

Parameter	Symbol	Conditions	Min.	Typ.	Max.	Units
Frequency Range	f		2400		2500	MHz
Input Power	P _{in}	f=2400 MHz to 2500 MHz	—	12.5	15	dBm
Output Power	P _{OUT}	@P _{IN_Typ.} , f=2400 MHz to 2500 MHz	250	300	—	Watts
			54	54.8	—	dBm
Power Gain	G _P	@P _{IN_Typ.} , f=2400 MHz to 2500 MHz	40	42	—	dB
Gain Flatness	G _{FLAT}	@P _{IN_Typ.} , f=2400 MHz to 2500 MHz	—	0.5	1.0	dB
Efficiency	η	@P _{IN_Typ.} , f=2400 MHz to 2500 MHz	52	60	—	
Input VSWR	I_VSWR	@P _{IN_Typ.} , f=2400 MHz to 2500 MHz	—	1.9:1	2.3:1	
Operating Voltage	V _{DC}	@P _{IN_Typ.} , f=2400 MHz to 2500 MHz	31.5	32	32.5	V
Supply Current	I _{DC}	@P _{IN_Typ.} , f=2400 MHz to 2500 MHz	—	16	18	A
Temperature Sense (based on analog output)	T _{sense}	T _{sense} =(-72.183 x TEMP_AOUT)+187.04 (TEMP_AOUT is the analog voltage on pin 8 of the conn. J2, temperature can also be read thru I2C)				°C
Supply Current Typical (based on analog output)	I _{current}	I _{current} = (6.21 x ISENSE_AOUT)-0.01 (ISENSE_AOUT is the analog voltage on pin 6 of the conn. J2, current can also be read thru I2C)				A
PA On / Off	-	Enable (TTL low) / Disable (TTL high) on Pin 5 of Connector J2				

PROTECTION LIMITS¹

Parameter	Symbol	Min.	Max.	Units
Temperature Sense ^{3,4}	T _{sense}	0	65	°C
Reverse Power	REFL_POWER_A	—	200	Watts
			53	dBm
Voltage Supply	VDS_SENSE_A	24	40	V
Current Supply	ISENSE_A	—	18	A

MAXIMUM RATINGS²

Parameter	Ratings
Operating Temperature ^{3,4}	0°C to +65°C
Storage Temperature	-20°C to +85°C
DC Voltage	40V
Input RF Power (no damage)	+15 dBm
Power (reflected or other RF source) into the RF output conn. (no damage)	200W

1. When the prestored limits are exceeded, the amplifier will shut-down and remain disabled until a reset command is sent thru the I2C interface or by applying a logic high level to pin 3 of connector J2.

2. Specifications apply to CW signals only. Permanent damage may occur if any of these limits are exceeded.

3. This is the sensed operating temperature calculated from the analog output or read thru I2C.

4. There is an offset from the temperature measured at the temp. sense location to the amplifier pallet base of approximately +10°C. I.e. When the internal sensed temperature read thru I2C from the PA is 65°C then the temperature at the base of the pallet is approximately +75°C.

HEATSINK REQUIREMENTS

Depending on the end system design or architecture either water cooling or air cooling must be used to cool the ZHL-2425-250X+ power amplifier module. In order to provide the user with the flexibility to decide on the cooling type, Mini-Circuits provides the ZHL-2425-250X+ without a heat sink and the user decides what type of cooling they want to use. It is absolutely critical that the amplifier is always mounted to a heatsink where the airflow of a fan on an air-cooled heat sink or the water temperature and flow rate of a water-cooled heatsink is set to keep the amplifier below 65degC at full RF power when operating, otherwise the amplifier will get too warm and the built-in protection alarms will be activated and the power amplifier will shut itself down. The Application note, [AN-60-110](#), describes how to mount the ZHL-245-250X+ to a Mini-Circuits air cooled heatsink ([HSK-2425-250+](#)). This is a heat sink that is designed specifically for the ZHL-2425-250X+ amplifier and is also available through the Mini-Circuits website.



APPLICATION

The ZHL-2425-250X+ amplifier module can be used as a building block in any single or multi-channel system for high power RF Energy applications such as:

- Industrial heating
- Materials processing
- Food processing (heating, tempering, and pasteurization)
- Microwave-assisted chemistry
- Plasma generation
- Plasma surface treatment
- Disinfection
- Chemistry
- RF-excited lasers
- Medical (heating, hyperthermia, and ablation)
- Semiconductor RF generators

BLOCK DIAGRAM

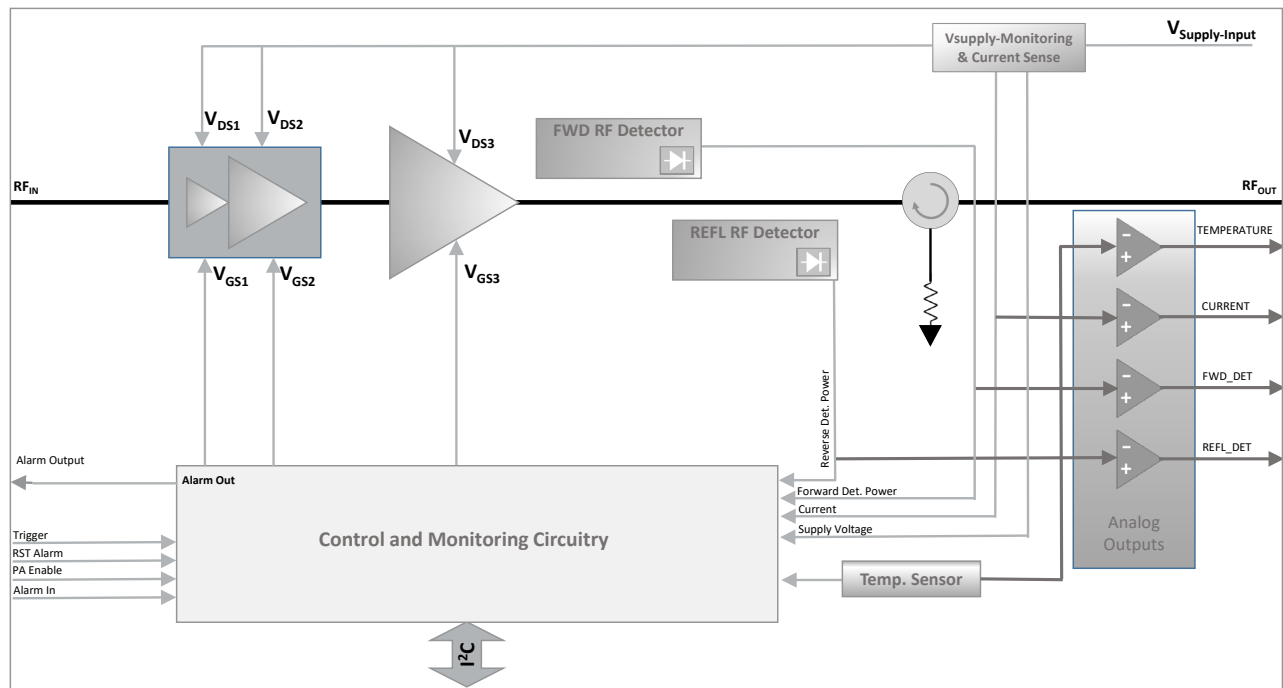

APPLICATION OVERVIEW

The ZHL-2425-250X+ can easily be driven by most standard signal generators, when connected to a DC power supply and mounted to a heat sink. The module is ready to deliver RF power to any applicator, i.e., a "device" to contain and/or apply the RF energy. The use of the latest generation solid state devices guarantees high efficiency, long lifetime, fully controllable and stable output power in a compact module outline. The amplifier has built-in monitoring and protection for temperature, current, supply voltage, forward power, reverse power, and internal shutdown circuitry for added reliability under difficult operating conditions, making it virtually impossible to destroy in single and multi-channel systems due to the integrated circulator and protection functions. When the prestored limits shown in the protection limits table are exceeded the amplifier will shut down and remain disabled until an alarm reset is sent either by an I2C command or a TTL high applied to pin 3 of the multi-pin connector J2. For advanced mode, users may consult the factory for more in-depth amplifier control commands, access to FWD/REFL power coefficients, and protection overrides. The ZHL-2425-250X+ can operate in both CW and PWM mode. When operating in PWM mode a minimum of four 1000uF or two 2400uF electrolytic capacitors should be used and located on the DC power supply line close to the amplifier supply terminals in parallel from the +32V supply to ground. These capacitors will increase reliability of the amplifier in PWM mode and improve the RF waveform overshoot and ripple in the pulse. Increasing the quantity of the electrolytic capacitors (4-8x 1000uF or 2-4x 2400uF) in parallel will extend the lifetime of these electrolytic capacitors.



There are two operation modes supported by the ZHL-2425-250X+

1. STANDARD OPERATION MODE (STDOM)

- PA Enable/Disable
- Built-in protection features enabled
- Ability to reset protection shutdown via I2C command or logic high on pin3
- Access to analog outputs for temperature, forward power, reverse power, and current that can be correlated to output power
- Access through the I2C to read Temperature (° C), forward power (dBm or W), reverse power (dBm or W), supply voltage (V), and current (A)
- The amplifiers are shipped from the factory in this mode.

2. ADVANCED OPERATION MODE (ADVOM)

- All of the “standard operation mode” features are available
- Access to the prestored protection limits for shutdown
- Access to enable/disable internal protection shutdown or change prestored internal shutdown limits (amplifier warranty is no longer valid in this situation).
- Access to all coefficients and digital data for forward detected power, reverse detected power, temperature, supply voltage, and current
- With either mode the external analog, digital signals, and control logic can optimize the RF vector (frequency, power, and time) depending on the application’s needs in real time.

CONTROL INTERFACE PIN OUT AND FUNCTIONALITY (J2 MULTI-PIN CONNECTOR, 3.3V LOGIC LEVELS)

Pin Number	Label	Type	Functionality and Control
1	TRIG_IN		Used during pulse mode operation.
2	REFL_AOUT		Analog voltage (0 to 3.3V) that can be correlated to the level of the reflected power or power incident at the J5 connector.
3	RST_ALARM		Reset Alarm – Internal protection shutdown can be reset thru the I2C communication or applying a TTL high to this pin.
4	FWD_AOUT		Analog voltage (0 to 3.3V) that can be correlated to the level of the forward output power.
5	PA_ENABLE		Enable (TTL low) / Disable (TTL high). Normally low, enabled, and can be disabled when a TTL high is applied.
6	ISENSE_AOUT		Analog voltage (0 to 3.3V) that correlates to the amplifier current level
7	ALARM_IN		This can be used by a system controller or another ZHL-2425-250X+ amplifier to send an alarm input to shut down the amplifier. This pin is normally low and can be set to a TTL high to shut-down the amplifier.
8	TEMP_AOUT		Analog voltage (0 to 3.3V) that can be correlated to the temperature. See equation in electrical specification table
9	Do Not Connect		Reserved pin for manufacturer
10	GND		Ground
11	ALARM_OUT		When the protection limits are exceeded and the amplifier is shutdown, this pin will go from normally TTL low to TTL high. This output can be used by an external controller to shut down the system or can be connected to other ZHL-2425-250X+ amplifiers ALARM_IN pins to shut them down.
12	GND		Ground
13	SCL		I2C control
14	GND		Ground
15	SDA		I2C control
16	GND		Ground
17	Do Not Connect		Reserved pin for manufacturer
18	Do Not Connect		Reserved pin for manufacturer
19	Do Not Connect		Reserved pin for manufacturer
20	Do Not Connect		Reserved pin for manufacturer

**I2C CONTROL AND BASIC COMMANDS (FIRMWARE VERSION A5)**

The ZHL-2425-250X+ supports the I2C bus communication standard.

Up to 8 units can be connected on the same I2C clock and data lines with the same base address and different *unit addresses* through 3 address bits (A2-A0).

Up to 8 units can be connected on the same I2C clock and data lines with the same base address and different unit addresses through 3 address bits (A2-A0). All amplifiers from the factory are set to local unit address of 0 by default. See example 1 to set the individual unit address.

The I2C 8 bits *control address* is composed as follows:

A base address of binary 1010 and 3 unit-address bits + a bit indicating a read or write operation: 1010 [A2][A1][A0][R/W];

the default *control address* hence evaluates to 0xA0 for a write operation. A2-A0 represents the address bits where logic high = 1 and logic low = 0. For an I2C bus write operation, the last bit W=Write must be 0; For a read operation, the last bit R=Read must be 1.

CW AND PULSE MODE OPERATION:

The amplifier can be operated in CW or pulsed mode. In order to obtain the correct results from reading ADC values with registers 101(ADC_FWD), 103(ADC_REFL), 105(ADC_Current), 107 (ADC_VDS), and reading power, current, and voltage from registers 245(FWD_dBm) , 247 (REFL_dBm), 249 (Current_Amp), 251 (VDS_Volt) through I2C from the ZHL-2425-250X+ the register 132 (ADC_Trigger_Mode) must be set correctly for each mode. The register 132 should be set to 0 (default) for CW signal mode and set to >0 for PWM mode.

For PWM mode, Pin 1, TRIG_IN, must be used to trigger the internal measurement during the pulse. When the ADC_Trigger_Mode, register 132, is set to >1 and a trigger is issued to Pin 1 on the ZHL-2425-250X+ the firmware will wait for the delay time set in register 130 (delay_after_trigger) and then record ADC values correlating to forward power, reflected power, current, and supply voltage in a total time of approximately 32µs. To avoid any error from ripple in the beginning of the pulse the delay after trigger has been set to a default minimum of 30µs. Therefore, the pulse width should not be <62µs, this is with the average count (register 134) set to 1 and the delay after trigger (register 130) set to the default of 30µs. The Pulse Width must be greater than DelayAfterTrigger(30µs minimum) +(32 x Avg_Count) µs. The results from reading registers 101, 103, 105, 107, 245, 247, 249, and 251 will be the values recorded after the last external trigger.

For CW the ADC_Trigger_Mode, register 132, should be set to 0. No external trigger is required and average count and delay after trigger is not used.

I2C REGISTER ADDRESSES (REQUEST CODE) LOWER THAN 140:

Sending data to the device for that register range will always be by sending the register address followed by 2 bytes High and Low. Reading data will always be 2 bytes of reading High then Low bytes successively (big endian). Data type integer.

Example 1: Set the individual unit local address to 1 - options for local address are 0 to 7 - default local address is 0

```
1. I2C_Start
2. I2C_Write (I2C_Control_Address_W) //control address - Write
3. I2C_Write (126) //Address register to set the local address
4. I2C_Write (0) //write high byte with value 0x00
5. I2C_Write (1) //write low byte with value 0x01
6. I2C_Stop // the new local address will be affected after next reset of the device
```

Example 2: Reset Alarm after internal protection shutdown event.

```
1. I2C_Start
2. I2C_Write (I2C_Control_Address_W) //control address - Write
3. I2C_Write (102) //Address register to set the reset code
4. I2C_Write (1) //write high byte with value 0x01
5. I2C_Write (1) //write low byte with value 0x01
6. I2C_Stop // the amplifier logic will reset the unit
```

Example 3: Read ADC_FWD value (ADC value correlating to forward detected power).

```
1. I2C_Start
2. I2C_Write (I2C_Control_Address_W) //control address - Write
3. I2C_Write (101) //Address register to get the ADC_FWD value
4. I2C_Stop
5. I2C_Start
6. I2C_Write (I2C_Control_Address_R) //Control Address - Read
7. ByteH=I2C_Read()
8. ByteL=I2C_Read()
9. I2C_Stop
```

**FOR I2C REGISTER ADDRESSES (REQUEST CODE) 140 AND ABOVE:**

Sending data to the device for this register range will always be by sending register address followed by 4 bytes of data High to low. Reading data will always be 4 bytes of data High to Low (big endian). **IMPORTANT:** Data should be interpreted as 32 bits float.

Example 4: Set the CAL frequency (i.e., the currently used frequency) for the frequency dependent data that will be read out later i.e., FWD_dBm, REFL_dBm. Parameters like Current_Amp, VDS_V, TFinal_deg do not depend on the current frequency used.

Set the I2CR_Set_CAL_freq to 2450 (Frequency is in MHz; 32bits float)

```
1. I2C_Start
2. I2C_Write (I2C_Control_Address_W) //control address - Write
3. I2C_Write (240) //Address register to set the cal_frequency value
4. I2C_Write (69) // Byte4
5. I2C_Write (25) // Byte3
6. I2C_Write (32) // Byte2
7. I2C_Write (0) // Byte1
8. I2C_Stop
```

Example 5: Get the output power in dBm at the frequency set in the previous example.

Get the I2CR_Get_FWD_dBm :

```
1. I2C_Start
2. I2C_Write (I2C_Control_Address_W) //control address - Write
3. I2C_Write (245) //Address register to get the FWD_dBm value
4. I2C_Stop
5. I2C_Start
6. I2C_Write (I2C_Control_Adress_R) //Control Address - Read
7. Byte4=I2C_Read()
8. Byte3=I2C_Read()
9. Byte2=I2C_Read()
10. Byte1=I2C_Read()
11. I2C_Stop
```



REGISTER TABLE:

Register #	Label	Function
98	Set_I2C_BaseAddress	Set base address, valid values are: 0x90, 0xA0, 0xB0
99	Get_I2C_BaseAddress	Read base address
101	Read_ADC_FWD	Read the ADC value correlating to forward power.
102	I2C_RST_ALARM	Reset the alarm that caused a shutdown. DataByte_L=1 DataByteH=1
103	Read_ADC_REFL	Read the ADC value correlating to reflected or reverse.
105	Read_ADC_Current	Read the ADC value correlating to the DC current drawn by the PA.
107	Read_ADC_VDS	Read the ADC value correlating to the measured supply voltage.
111	Read_ADC_TFinal	Read the ADC value correlating to the temperature.
113	Get_FirmwareID	Read the current firmware ID
115	Get_FirmwareVersion	Read the current firmware version
119	Get_InternalAlarm_Cause	Read the internal alarm cause*
126	Set_I2C_LocalAddress	Set unit address bits [0-7]; requires unit reset to take effect
127	Get_I2C_LocalAddress	Read unit address
129	I2C_Get_AvgCount	Get Average count for reading ADCs when triggered.
130	I2C_Set_DelayAfterTrigger	For PWM operation, set delay after trigger before FWD_ADC, REFL_ADC, VDS_ADC, and Current_ADC values are read during the pulse and saved in firmware. Default set to 30µs.
131	I2C_Get_DelayAfterTrigger	For PWM operation, Read delay after trigger
132	Set_ADC_Trigger_Mode	Set 0 for "normal" reading during CW operation or positive number for Trigger Mode reading during PWM operation. (See para. CW and Pulse Mode Operation above)
133	Get_ADC_Trigger_Mode	
134	I2C_Set_AvgCount	For PWM operation, Set Average count for reading ADCs when triggered. Min. Average Count is 1 (default), Max. is 50.
240	I2CR_Set_CAL_freq	Set freq. in MHz for the data to be read from in registers 241, 245, 247
241	I2CR_Get_CAL_freq	Read Cal frequency in MHz
245	I2CR_Get_FWD_dBm	Read forward power in dBm (4 bytes float)
247	I2CR_Get_REFL_dBm	Read reflect power in dBm (4 bytes float)
249	I2CR_Get_Current_Amp	Read amplifier current in Amps (4 bytes float)
251	I2CR_Get_VDS_Volt	Read Vsupply in volts (4 bytes float)
253	I2CR_Get_TFinal_deg	Read temperature in °C (4 bytes float)

*Internal Alarm Cause:

2 bytes value, each bit represents and alarm cause as follows. (bits 8, 9, 12,13,14, and 15 are reserved)

bit0: Reflected Power > Upper Limit

bit1: Reflected Power < Lower Limit ¹

bit2: Forward Power > Upper Limit ¹

bit3: Forward Power < Lower Limit ¹

bit4: Current > Upper Limit

bit5: Current < Lower Limit ¹

bit6: VSupply > Upper Limit

bit7: Vsupply < Lower Limit

bit10: Temperature > Upper Limit

bit11: Temperature < Lower Limit

1. There is no protection limit set, so there should never be an internal alarm for these parameters.



OUTLINE DRAWING

*M3 SHCS (DIN 912, ISO 21269)
Recommended.
For Mounting, Torque to max.
1.5Nm (13lbf in)

Mounting Hole Locations
(Lid Requires Temporary Removal to Install Mounting Screws)

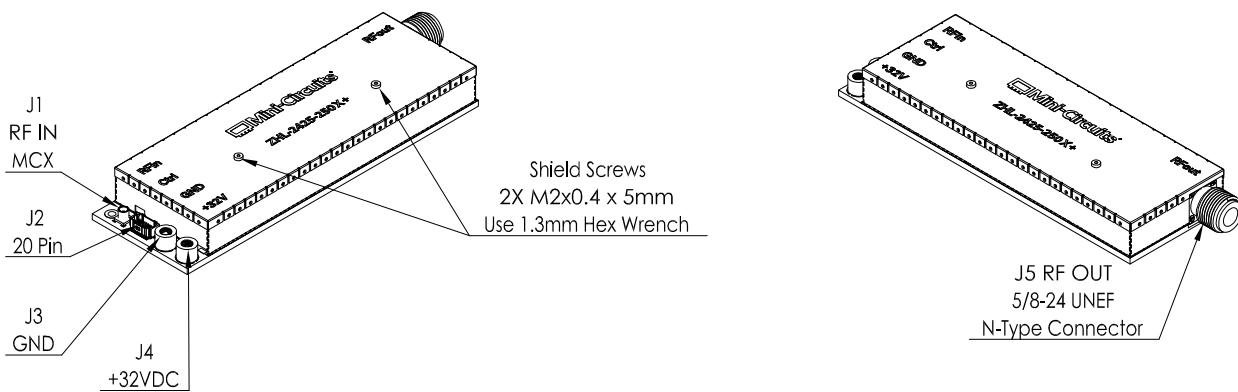
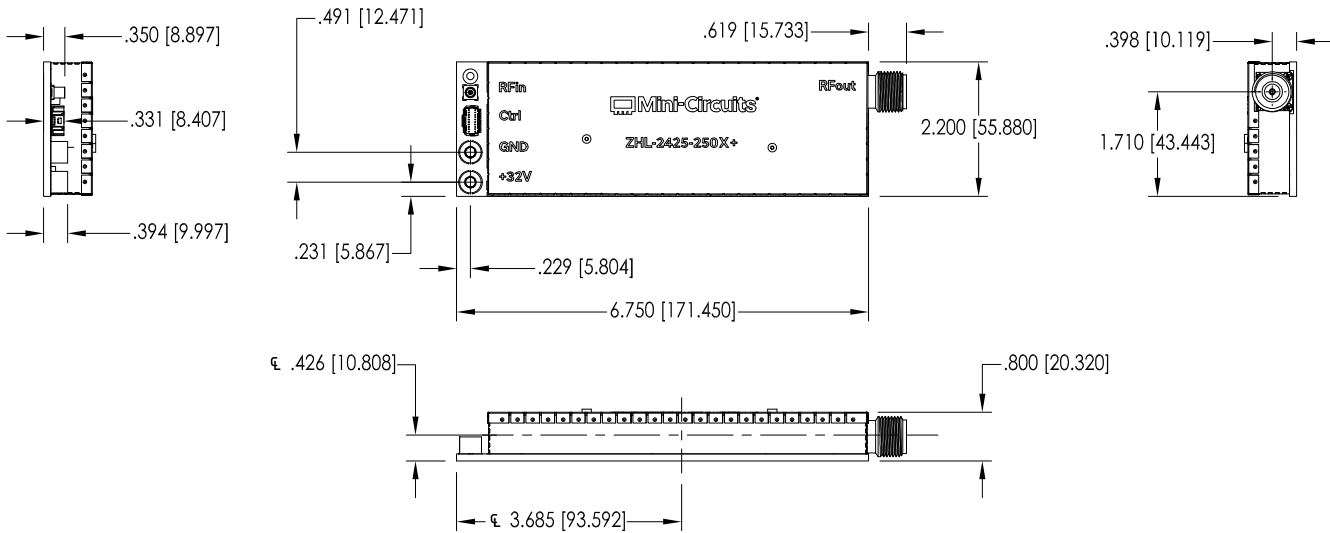
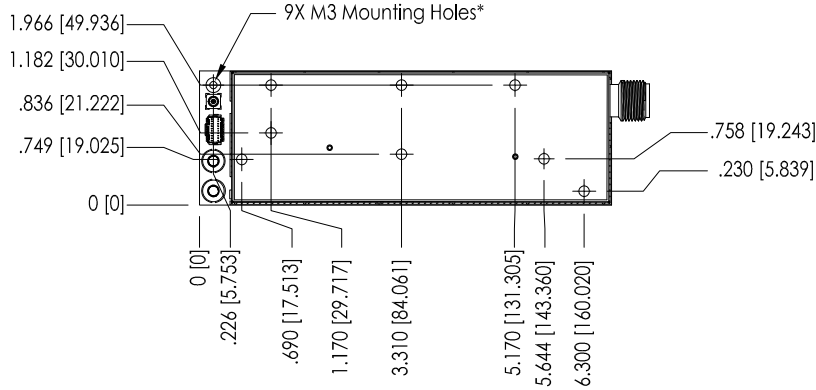



TYPICAL PERFORMANCE DATA (32V, 50Ω SYSTEM)

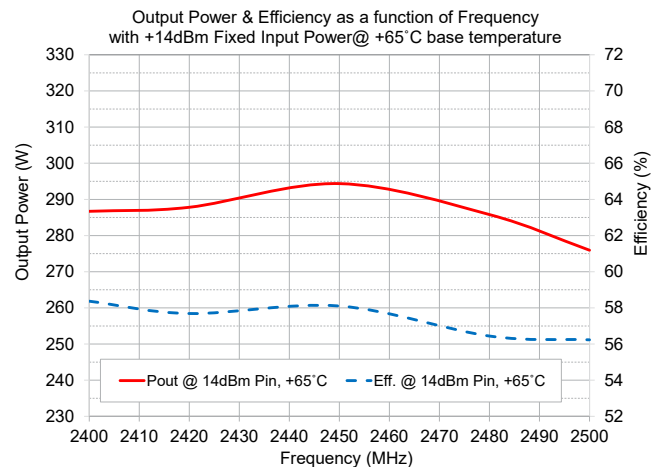
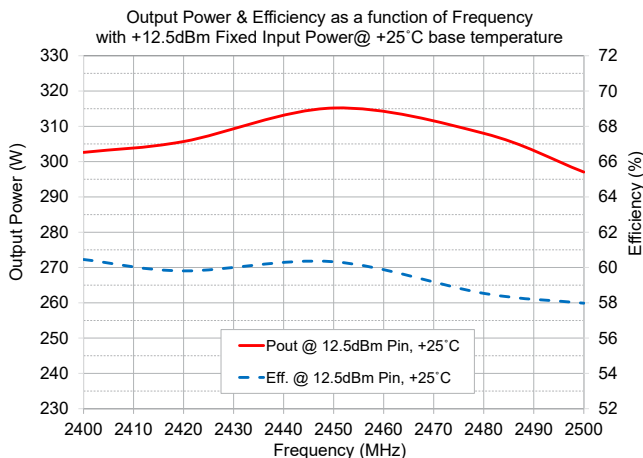
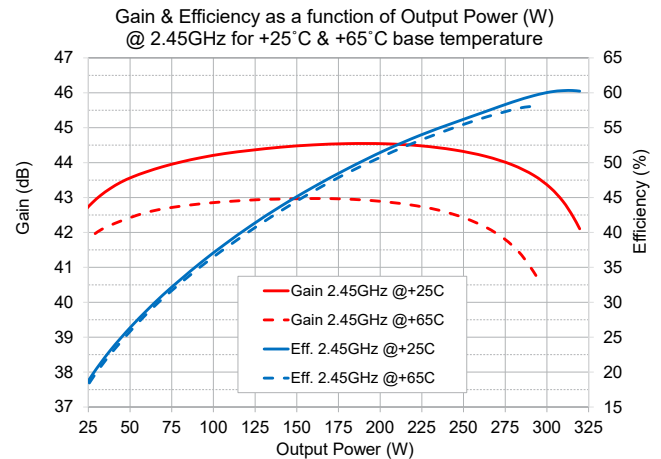
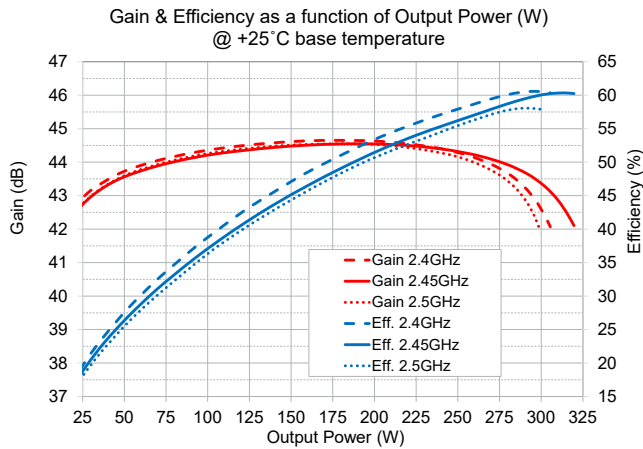
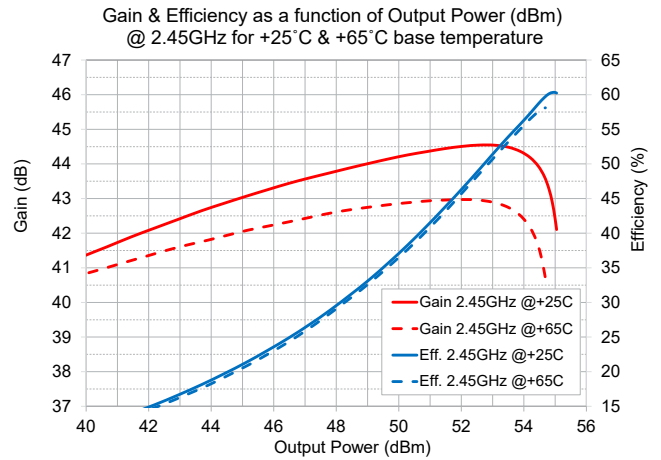
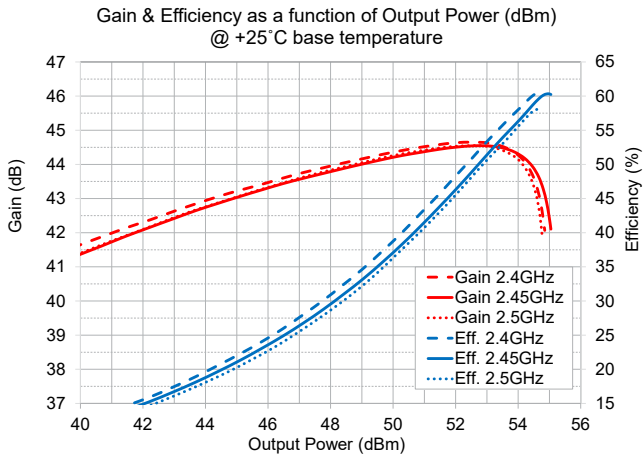



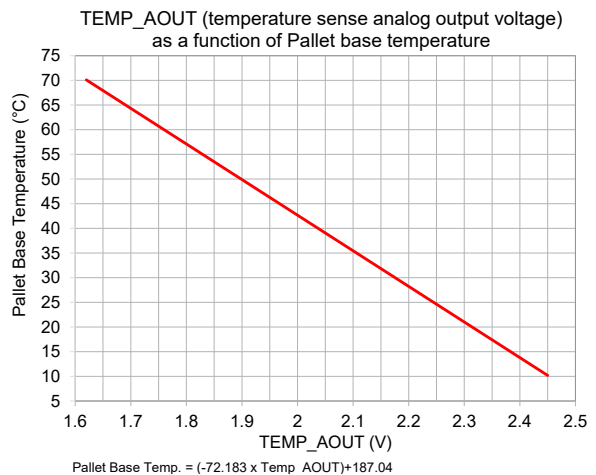
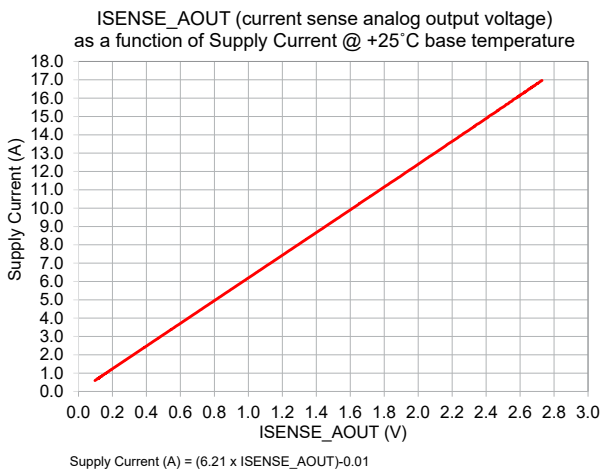
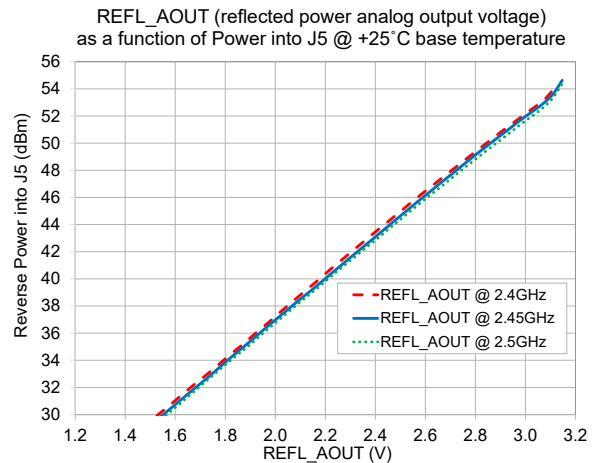
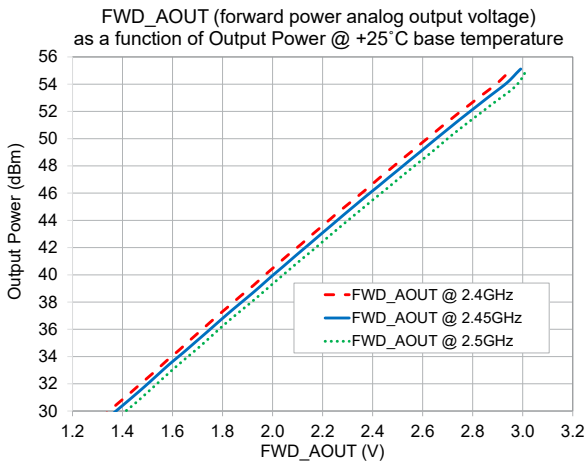
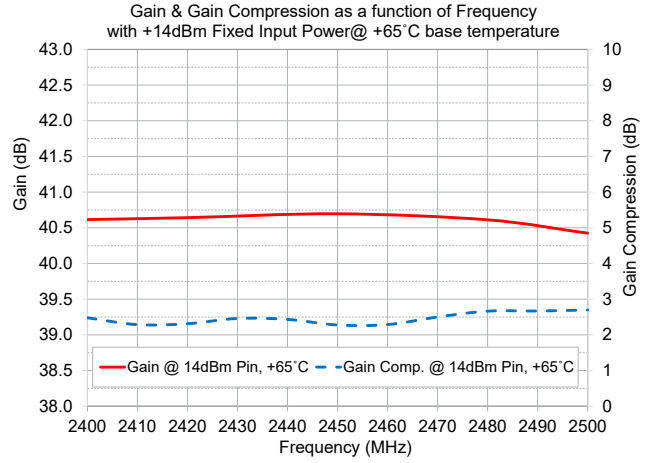
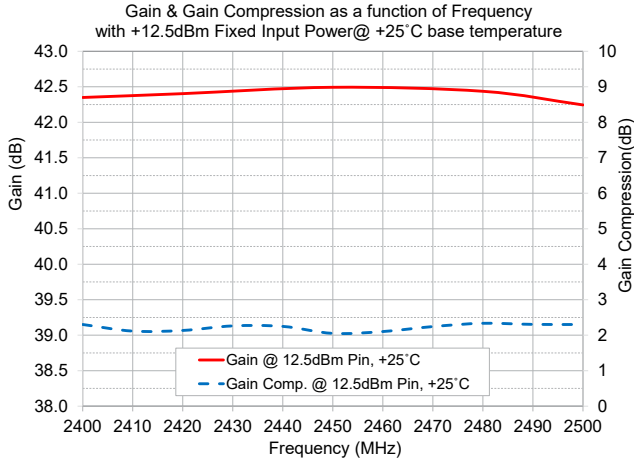

TYPICAL PERFORMANCE DATA (32V, 50Ω SYSTEM)



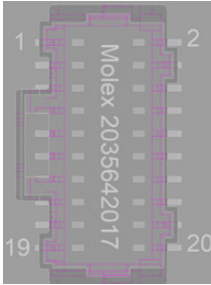

AMPLIFIER INTERFACES AND SUGGESTED MATING HARDWARE*

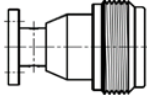
	<p>J1 - MCX Connector Jack, Female Socket 50 Ohm (Molex P/N 73415-1692)</p> <p>Mating CBL ASSY SMA female-MCX male RG316 6", Amphenol RF P/N 245130-01-06.00 (other lengths avail.)</p>
	<p>J2 - Control Connector, 20 Pin (Molex 203564-2017)</p> <p>Mating connector shell, Molex 501189-2010, and cables with pre-crimped leads, Molex 79758-1018 or 79758-1019.</p>
	<p>J3 - Ground Conn., M5 J4 - +32V Supply Conn., M5</p> <p>Tightening Torque 1.7 N-m (15 in-lbs) with max. of 2.15 N-m (19 in-lbs)</p> <p>Mating M5 screw (Mcmaster P/N 92095A308) Belville washer (Mcmaster P/N 90895A027) Ring Terminal (Mcmaster P/N7113K29)</p>
	<p>Output connector N-type female Recommended Torque for N-type connector mate is 1.36 N-m (12 in-lbs)</p>

*Mating hardware not included with amplifier. Similar mating hardware available from other manufactures.

NOTES

- A. Performance and quality attributes and conditions not expressly stated in this specification document are intended to be excluded and do not form a part of this specification document.
- B. Electrical specifications and performance data contained in this specification document are based on Mini-Circuit's applicable established test performance criteria and measurement instructions.
- C. The parts covered by this specification document are subject to Mini-Circuits standard limited warranty and terms and conditions (collectively, "Standard Terms"); Purchasers of this part are entitled to the rights and benefits contained therein. For a full statement of the standard. Terms and the exclusive rights and remedies thereunder, please visit Mini-Circuits' website at www.minicircuits.com/MCLStore/terms.jsp

Mouser Electronics

Authorized Distributor

Click to View Pricing, Inventory, Delivery & Lifecycle Information:

[Mini-Circuits:](#)

[ZHL-2425-250X+](#)