

Stepper Motor Drive Circuit

FEATURES

- Complete Motor Driver and Encoder
- Continuous Drive Capability 350mA per Phase
- Contains all Required Logic for Full and Half Stepping
- Bilevel Operation for Fast Step Rates
- Operates as a Voltage Doubler
- Useable as a Phase Generator and/or as a Driver
- Power-On Reset Guarantees Safe, Predictable Power-Up

DESCRIPTION

The UC3517 contains four NPN drivers that operate in two-phase fashion for full-step and half-step motor control. The UC3517 also contains two emitter followers, two monostables, phase decoder logic, power-on reset, and low-voltage protection, making it a versatile system for driving small stepper motors or for controlling large power devices.

The emitter followers and monostables in the UC3517 are configured to apply higher-voltage pulses to the motor at each step command. This drive technique, called "Bilevel," allows faster stepping than common resistive current limiting, yet generates less electrical noise than chopping techniques.

ABSOLUTE MAXIMUM RATINGS

Second Level Supply, V _{ss}	40V
Phase Output Supply, V _{MM}	40V
Logic Supply, V _{cc}	7V
Logic Input Voltage	-3V to +7V
Logic Input Current	±10mA
Output Current, Each Phase	500mA
Output Current, Emitter Follower	500mA
Power Dissipation, (Note)	1W

Power Dissipation, (Note)	2W
Junction Temperature	150°C
Ambient Temperature, UC1517	-55°C to +125°C
Ambient Temperature, UC3517	0°C to +70°C
Storage Temperature	-55°C to +150°C

Note: Consult Packaging section of Databook for thermal limitations and considerations of package.

BLOCK DIAGRAM

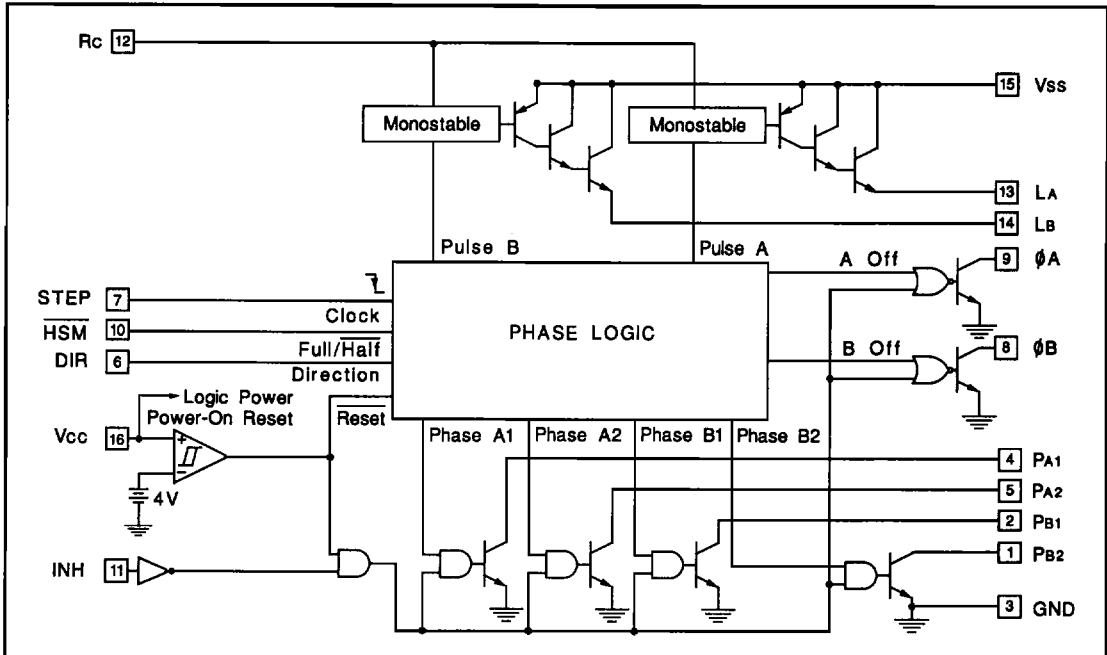

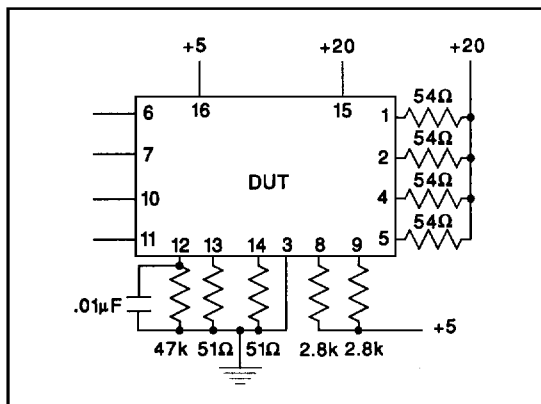

Figure 3. Test Circuit

PIN DESCRIPTION

Vcc: Vcc is the UC3517's logic supply. Connect to a regulated 5VDC, and bypass with a 0.1µF ceramic capacitor to absorb switching transients.

VMM: VMM is the primary motor supply. It connects to the UC3517 phase outputs through the motor windings. Limit this supply to less than 40V to prevent breakdown of the phase output transistors. Select the nominal VMM voltage for the desired continuous winding current.

Vss: Vss is the secondary motor supply. It drives the LA and LB outputs of the UC3517 when a monostable in the UC3517 is active. In the bilevel application, this supply is applied to the motor to charge the winding inductance faster than the primary supply could. Typically, Vss is higher in voltage than VMM, although Vss must be less than 40V. The Vss supply should have good transient capability.

GROUND: The ground pin is the common reference for all supplies, inputs and outputs.

RC: RC controls the timing functions of the monostables in the UC3517. It is normally connected to a resistor (RT) and a capacitor (CT) to ground, as shown in Figure 3. Monostable on time is determined by the formula $T_{ON} \approx 0.69 R_T C_T$. To keep the monostable on indefinitely, pull RC to Vcc through a 50k resistor. The UC3517 contains only one RC pin for two monostables. If step rates comparable to T_{ON} are commanded, incorrect pulsing can result, so consider maximum step rates when selecting RT and CT. Keep $T_{ON} \leq T_{STEP MAX}$.

OA and OB: These logic outputs indicate half-step position. These outputs are open-collector, low-current drivers, and may directly drive TTL logic. They can also drive CMOS logic if a pull-up resistor is provided. Systems which use the UC3517 as an encoder and use a different driver can use these outputs to disable the external driver,

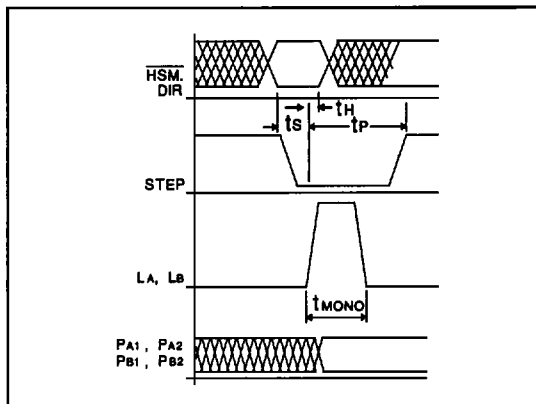

Figure 4. Timing Waveforms

as shown in Figure 8. The sequencing of these outputs is shown in Figure 5.

PA1, PA2, PB1, and PB2: The phase outputs pull to ground sequentially to cause motor stepping, according to the state diagram of Figure 5. The sequence of stepping on these lines, as well as with the LA and LB lines is controlled by STEP input, the DIR input, and the HSM input. Caution: If these outputs or any other IC pins are pulled too far below ground either continuously or in a transient, step memory can be lost. It is recommended that these pins be clamped to ground and supply with high-speed diodes when driving inductive loads such as motor windings or solenoids. This clamping is very important because one side of the winding can "kick" in a direction opposite the swing of the other side.

LA and LB: These outputs pull to Vss when their corresponding monostable is active, and will remain high until the monostable time elapses. Before and after, these outputs are high-impedance. For detail timing information, consult Figure 5.

STEP: This logic input clocks the logic in the UC3517 on every falling edge. Like all other UC3517 inputs, this input is TTL/CMOS compatible, and should not be pulled below ground.

DIR: This logic input controls the motor rotation direction by controlling the phase output sequence as shown in Figure 5. This signal must be stable 400ns before a falling edge on STEP, and must remain stable through the edge to insure correct stepping.

HSM: This logic input switches the UC3517 between half-stepping (HSM = low) and full-stepping (HSM = high) by controlling the phase output sequence as shown in Figure 5. This line requires the same set-up time as the DIR input, and has the same hold requirement.

INH: When the inhibit input is high, the phase and θ outputs are inhibited (high impedance). STEP pulses received while inhibited will continue to update logic in the IC, but the states will not be reflected at the outputs until inhibit is pulled low. In stepper motor systems, this can be used to save power or to allow the rotor to move freely for manual repositioning.

OPERATING MODES

The UC3517 is a system component capable of many different operating modes, including:

Unipolar Stepper Driver: In its simplest form, the UC3517 can be connected to a stepper motor as a unipolar driver. LA, LB, RC and Vss are not used, and may be left open. All other system design considerations mentioned above apply, including choice of motor supply VMM, undershoot diodes and timing considerations.

Unipolar Bilevel Stepper Driver: If increased step rates are desired, the application circuit of Figure 6 makes use of the monostables and emitter followers as well as the configuration mentioned above to provide high-voltage pulses to the motor windings when the phase is turned on. For a given dissipation level, this mode offers faster step rates, and very little additional electrical noise.

The choice of monostable components can be estimated based on the timing relationship of motor current and voltage: $V = Ldi/dt$. Assuming a fixed secondary supply voltage (Vss), a fixed winding inductance (LM), a desired winding peak current (Iw), and no back EMF from the motor, we can estimate that $RTCT = 1.449 IwLM/Vss$. In practice, these calculations should be confirmed and adjusted to accommodate for effects not modeled.

Voltage-Doubled Mode: The UC3517 can also be used to generate higher voltages than available with the system power supplies using capacitors and diodes. Figure 9 shows how this might be done, and gives some estimates for the component values.

Higher Current Operation: For systems requiring more than 350mA of drive per phase, the UC3717A can be

used in conjunction with discrete power transistors or power driver ICs, like the L298. These can be connected as current gain devices that turn on when the phase outputs turn on.

Bipolar Motor Drive: Bipolar motors can be controlled by the UC3517 with the addition of bipolar integrated drivers such as the UC3717A (Figure 8) and the L298, or discrete devices. Care should be taken with discrete devices to avoid potential cross-conduction problems.

LOGIC FLOW GRAPH

The UC3517 contains a bidirectional counter which is decoded to generate the correct phase and θ outputs. This counter is incremented on every falling edge of the STEP input. Figure 5 shows a graph representing the counter sequence, inputs that determine the next state (DIR and HSM), and the outputs at each state. Each circle represents a unique logic state, and the four inside circles represent the half-step states.

The four bits inside the circles represent the phase outputs in each state (PA1, PA2, PB1, and PB2). For example, the circle labeled 1010 is immediately entered when the device is powered up, and represents PA1 off ("1" or high), PA2 on ("0" or low), PB1 off ("1" or high) and PB2 on ("0" or low). The θA and θB outputs are both low (unidentified).

The arrows in the graph show the state changes. For example, if the IC is in state 0110, DIR is high, HSM is high, and STEP falls, the next state will be 0101, and a pulse will be generated on the LB line by the monostable.

Inhibit will not effect the logic state, but it will cause all phase outputs and both θ outputs to go high (off). A falling edge on STEP will still cause a state change, but inhibit will have to toggle low for the state to be apparent.

A falling edge on STEP with HSM high will cause the counter to advance to the next full step state regardless of whether or not it was in a full step state previously.

No LA or LB pulses are generated entering half-states.

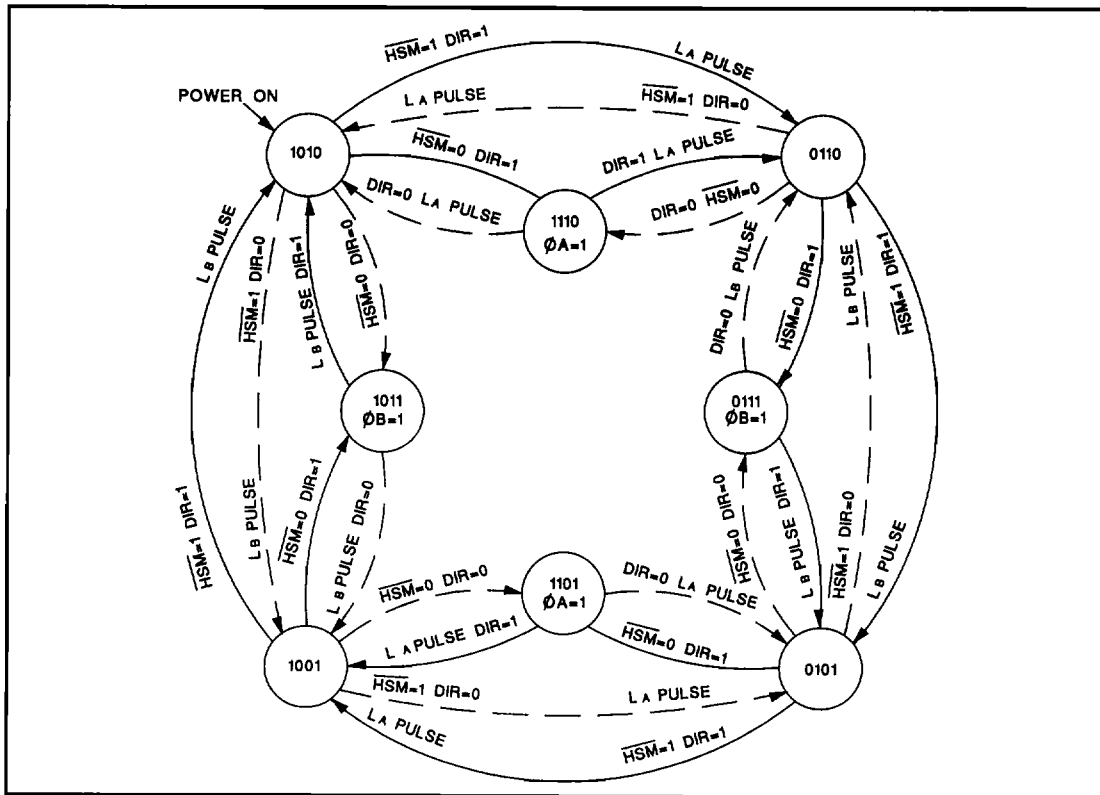
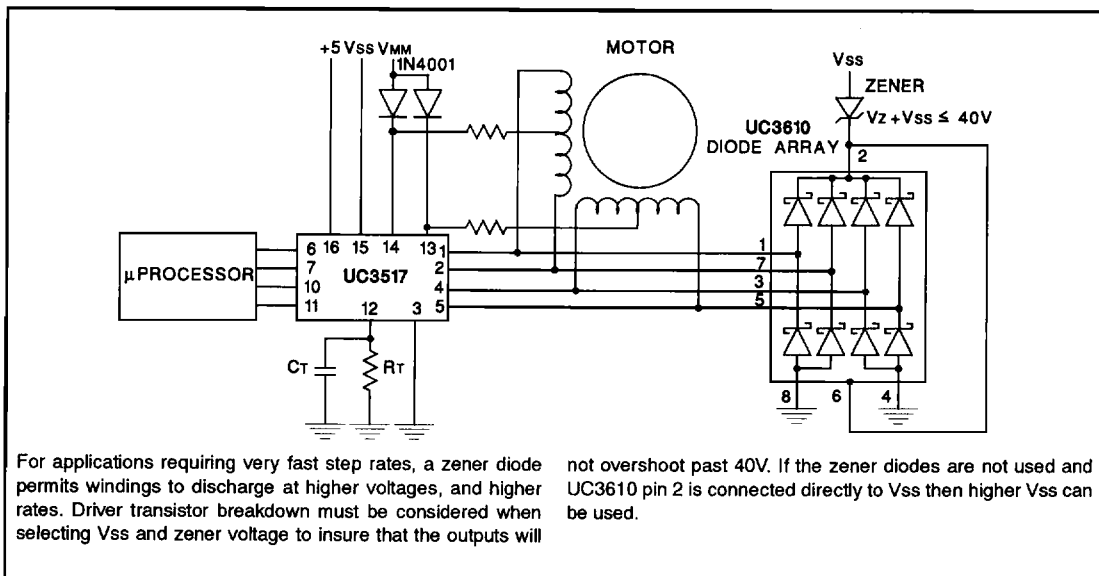

Figure 5. Logic Flow Graph



For applications requiring very fast step rates, a zener diode permits windings to discharge at higher voltages, and higher rates. Driver transistor breakdown must be considered when selecting Vss and zener voltage to insure that the outputs will

not overshoot past 40V. If the zener diodes are not used and UC3610 pin 2 is connected directly to Vss then higher Vss can be used.

Figure 6. Bilevel Motor Driver

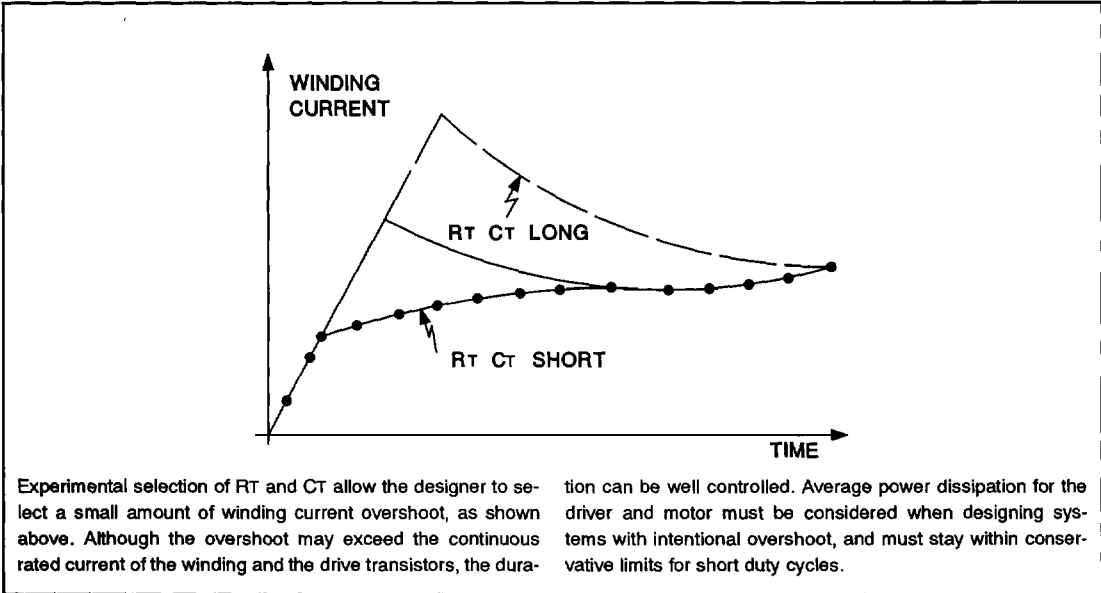

Figure 7. Effects of Different R_T & C_T on Bilevel Systems

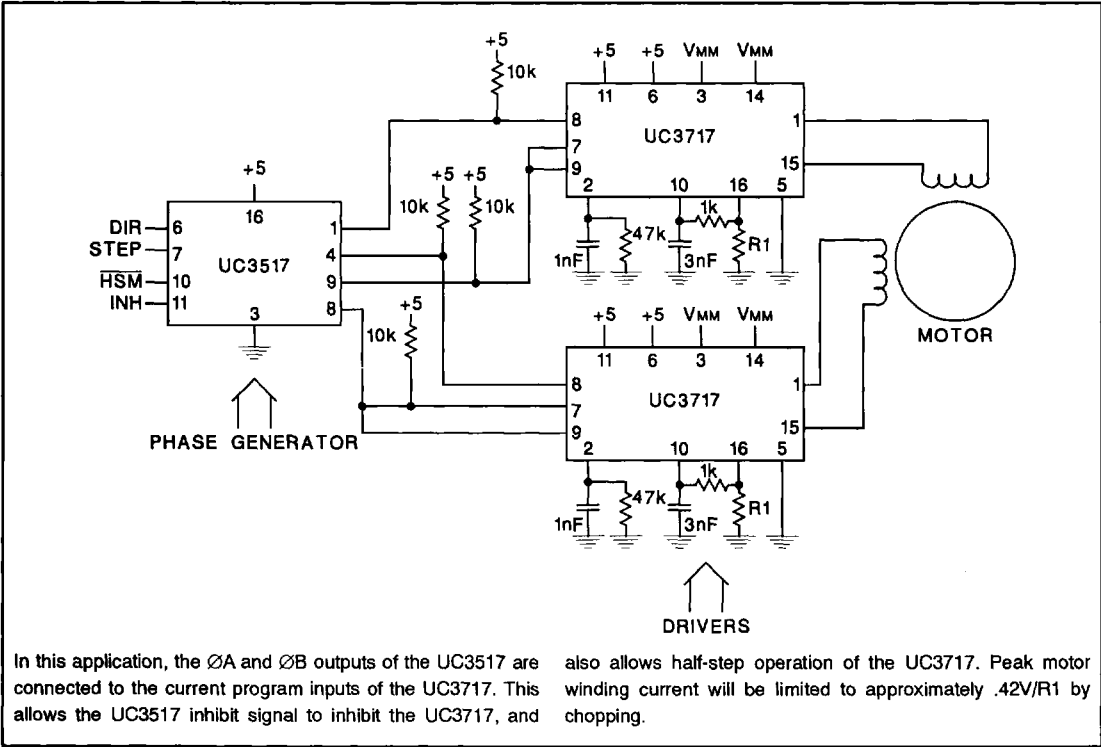
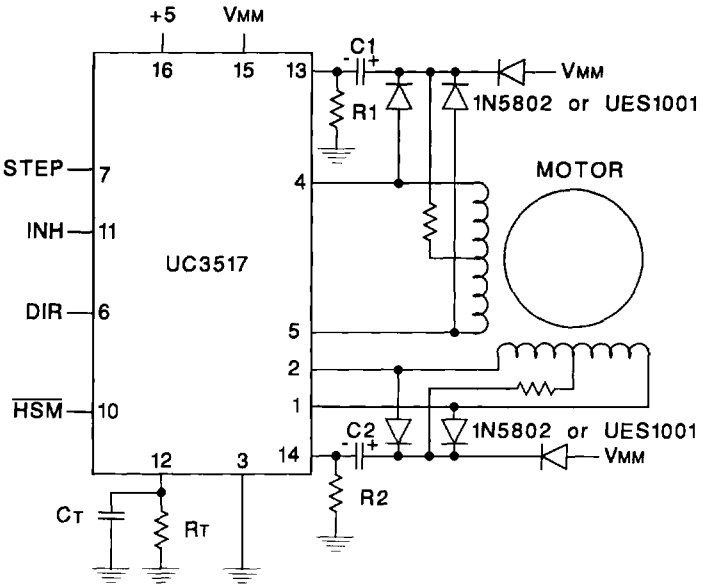

Figure 8. Interface to UC3717 Bipolar Driver



Although component values can be best optimized experimentally, good starting values speed development. For this design, start with:

$R_T C_T = 3 L_w / R_w$
 $C_1 = C_2 = L_w I_R / R_w$
 $R_1 = R_2 = 2.9 T_{MIN} / C_1$

where:

L_w is winding inductance,
 R_w is winding resistance,
 I_R is rated winding current, and
 T_{MIN} is minimum step period expected.

Figure 9. Using the UC3517 as a Voltage Doubler