

# Stereo BTL audio output amplifier with DC volume control

## TDA7053A

### FEATURES

- DC volume control
- Few external components
- Mute mode
- Thermal protection
- Short-circuit proof
- No switch-on and switch-off clicks
- Good overall stability
- Low power consumption
- Low HF radiation
- ESD protected on all pins.

### GENERAL DESCRIPTION

The TDA7053A ( $2 \times 1$  W) and TDA7053AT ( $2 \times 0.5$  W) are stereo BTL output amplifiers with DC volume control. The devices are designed for use in TV and monitors, but are also suitable for battery-fed portable recorders and radios.

### Missing Current Limiter (MCL)

A MCL protection circuit is built-in. The MCL circuit is activated when the difference in current between the output terminal of each amplifier exceeds 100 mA (typical 300 mA). This level of 100 mA allows for headphone applications (single-ended).

### QUICK REFERENCE DATA

SYMBOL	PARAMETER	CONDITIONS	MIN.	TYP.	MAX.	UNIT
$V_P$	supply voltage		4.5	–	18	V
$P_{out}$	output power TDA7053A TDA7053AT	$V_P = 6$ V $R_L = 8 \Omega$ $R_L = 16 \Omega$	0.85 0.5	1.0 0.6	– –	W W
$G_V$	voltage gain		39.5	40.5	41.5	dB
$G_C$	gain control		68.0	73.5	–	dB
$I_{q(tot)}$	total quiescent current	$V_P = 6$ V; $R_L = \infty$	–	22	25	mA
THD	total harmonic distortion TDA7053A TDA7053AT	$P_{out} = 0.5$ W $P_{out} = 0.25$ W	– –	0.3 0.3	1 1	% %

### ORDERING INFORMATION

TYPE NUMBER	PACKAGE		
	NAME	DESCRIPTION	VERSION
TDA7053A	DIP16	plastic dual in-line package; 16 leads (300 mil); long body	SOT38-1
TDA7053AT	SO16	plastic small outline package; 16 leads; body width 7.5 mm	SOT162-1

Stereo BTL audio output amplifier with DC volume control

TDA7053A

BLOCK DIAGRAM

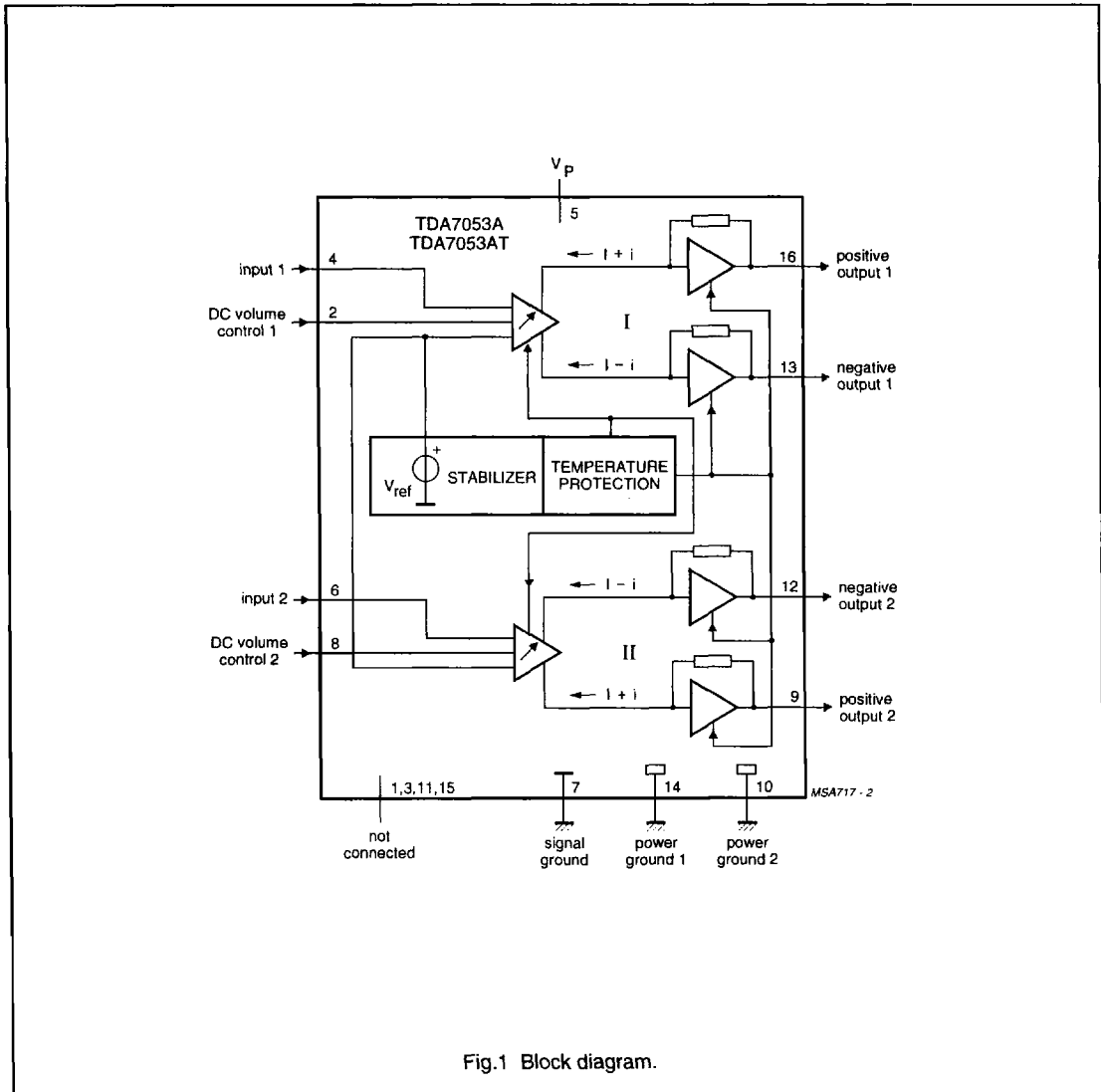

Fig.1 Block diagram.

# Stereo BTL audio output amplifier with DC volume control

## TDA7053A

### PINNING

SYMBOL	PIN	DESCRIPTION
n.c.	1	not connected
VC1	2	DC volume control 1
n.c.	3	not connected
$V_{I(1)}$	4	voltage input 1
$V_P$	5	positive supply voltage
$V_{I(2)}$	6	voltage input 2
SGND	7	signal ground
VC2	8	DC volume control 2
OUT2+	9	positive output 2
PGND2	10	power ground 2
n.c.	11	not connected
OUT2-	12	negative output 2
OUT1-	13	negative output 1
PGND1	14	power ground 1
n.c.	15	not connected
OUT1+	16	positive output 1

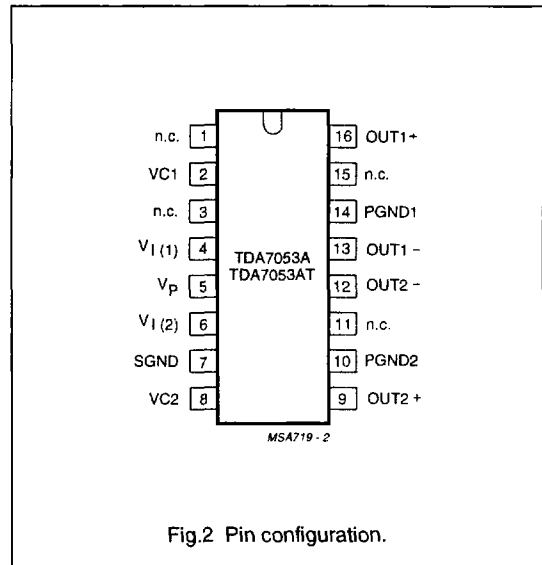

Fig.2 Pin configuration.

### FUNCTIONAL DESCRIPTION

The TDA7053A and TDA7053AT are stereo output amplifiers with two DC volume control stages, designed for TV and monitors, but also suitable for battery-fed portable recorders and radios.

In conventional DC volume control circuits the control or input stage is AC coupled to the output stage via external capacitors to keep the offset voltage low.

The two DC volume control stages are integrated into the input stages so that no coupling capacitors are required and a low offset voltage is still maintained. The minimum supply voltage also remains low.

The BTL principle offers the following advantages:

- Lower peak value of the supply current
- The frequency of the ripple on the supply voltage is twice the signal frequency.

Consequently, a reduced power supply with smaller capacitors can be used which results in cost reductions.

For portable applications there is a trend to decrease the supply voltage, resulting in a reduction of output power at conventional output stages. Using the BTL principle increases the output power.

The maximum gain of the amplifier is fixed at 40.5 dB. The DC volume control stages have a logarithmic control characteristic. Therefore, the total gain can be controlled from +40.5 to -33 dB.

If the DC volume control voltage falls below 0.4 V, the device will switch to the mute mode.

The amplifier is short-circuit protected to ground,  $V_P$  and across the load. A thermal protection circuit is also implemented. If the crystal temperature rises above 150 °C the gain will be reduced, thereby reducing the output power.

Special attention is given to switch-on and switch-off clicks, low HF radiation and a good overall stability.

# Stereo BTL audio output amplifier with DC volume control

TDA7053A

## LIMITING VALUES

In accordance with the Absolute Maximum Rating System (IEC 134).

SYMBOL	PARAMETER	CONDITIONS	MIN.	MAX.	UNIT
$V_P$	supply voltage		–	18	V
$I_{ORM}$	repetitive peak output current		–	1.25	A
$I_{OSM}$	non-repetitive peak output current		–	1.5	A
$P_{tot}$	total power dissipation	$T_{amb} \leq 25\text{ °C}$	–	2.5	W
	TDA7053A		–	1.32	W
$t_{sc}$	short-circuit time		–	1	hr
$V_n$	input voltage pins 2, 4, 6 and 8		–	5	V
$T_{amb}$	operating ambient temperature		–40	+85	°C
$T_{stg}$	storage temperature		–55	+150	°C
$T_{vj}$	virtual junction temperature		–	+150	°C

## THERMAL CHARACTERISTICS

SYMBOL	PARAMETER	VALUE	UNIT
$R_{th\ j-a}$	thermal resistance from junction to ambient in free air		
	TDA7053A	50	K/W
	TDA7053AT	95	K/W

### Power dissipation

TDA7053A:

Assume  $V_P = 6\text{ V}$  and  $R_L = 8\ \Omega$ .

The maximum sine wave dissipation is  $2 \times 0.9\text{ W} = 1.8\text{ W}$ .

The  $R_{th\ j-a}$  of the package is 50 K/W therefore  $T_{amb(max)} = 150 - (50 \times 1.8) = 60\text{ °C}$ .

TDA7053AT:

Assume  $V_P = 6\text{ V}$  and  $R_L = 16\ \Omega$ .

The maximum sine wave dissipation is  $2 \times 0.46\text{ W} = 0.92\text{ W}$ .

The  $R_{th\ j-a}$  of the package is 95 K/W therefore  $T_{amb(max)} = 150 - (95 \times 0.92) = 62.6\text{ °C}$ .

# Stereo BTL audio output amplifier with DC volume control

TDA7053A

**CHARACTERISTICS**

$V_P = 6\text{ V}$ ;  $T_{\text{amb}} = 25\text{ }^\circ\text{C}$ ;  $f_i = 1\text{ kHz}$ ; TDA7053A:  $R_L = 8\text{ }\Omega$ ; TDA7053AT:  $R_L = 16\text{ }\Omega$ ; unless otherwise specified (see Fig. 13).

SYMBOL	PARAMETER	CONDITIONS	MIN.	TYP.	MAX.	UNIT
$V_P$	supply voltage		4.5	–	18	V
$I_{q(\text{tot})}$	total quiescent current	$V_P = 6\text{ V}$ ; $R_L = \infty$ ; note 1	–	22	25	mA
<b>Maximum gain; <math>V_{2,8} \geq 1.4\text{ V}</math></b>						
$P_{\text{out}}$	output power	THD = 10%				
	TDA7053A		1.0	1.1	–	W
	TDA7053AT		0.5	0.6	–	W
THD	total harmonic distortion					
	TDA7053A	$P_{\text{out}} = 0.5\text{ W}$	–	0.3	1	%
	TDA7053AT	$P_{\text{out}} = 0.25\text{ W}$	–	0.3	1	%
$G_V$	voltage gain		39.5	40.5	41.5	dB
$V_{I(\text{rms})}$	input signal handling (RMS value)	$G_V = 0\text{ dB}$ ; THD < 1%	1	–	–	V
$V_{\text{no}}$	noise output voltage	$f_i = 500\text{ kHz}$ ; note 2	–	210	–	$\mu\text{V}$
B	bandwidth	at $-1\text{ dB}$	–	note 3	–	Hz
SVRR	supply voltage ripple rejection	note 4	34	38	–	dB
$V_{O(\text{os})}$	DC output offset voltage	$ V_{16} - V_{13} $ and $ V_{12} - V_9 $	–	0	200	mV
$Z_i$	input impedance (pins 4 and 6)		15	20	25	k $\Omega$
$\alpha_{\text{cs}}$	channel separation	$R_S = 5\text{ k}\Omega$	40	–	–	dB
$ G_V $	channel unbalance	note 5	–	–	1	dB
		$G_1 = 0\text{ dB}$ ; note 6	–	–	1	dB
<b>Mute position; <math>V_{2,8} = 0.4\text{ V} \pm 30\text{ mV}</math></b>						
$V_O$	output voltage in mute position	$V_1 = 1.0\text{ V}$ ; note 7	–	–	30	$\mu\text{V}$
<b>DC volume control</b>						
$G_C$	gain control		68.5	73.5	–	dB
$I_{\text{DC}}$	volume control current	$V_2 = V_8 = 0\text{ V}$	–20	–25	–30	$\mu\text{A}$

**Notes**

- With a load connected to the outputs the quiescent current will increase, the maximum value of this increase being equal to the DC output offset voltage divided by  $R_L$ .
- The noise output voltage (RMS value) at  $f_i = 500\text{ kHz}$  is measured with  $R_S = 0\text{ }\Omega$  and bandwidth = 5 kHz.
- 20 Hz to 300 kHz (typical).
- The ripple rejection is measured with  $R_S = 0\text{ }\Omega$  and  $f_i = 100\text{ Hz}$  to 10 kHz. The ripple voltage of 200 mV (RMS value) is applied to the positive supply rail.
- The channel unbalance is measured with  $V_{\text{DC}1} = V_{\text{DC}2}$ .
- The channel unbalance at  $G_1 = 0\text{ dB}$  is measured with  $V_{\text{DC}1} = V_{\text{DC}2}$ .
- The noise output voltage (RMS value) is measured with  $R_S = 5\text{ k}\Omega$  unweighted.

# Stereo BTL audio output amplifier with DC volume control

TDA7053A

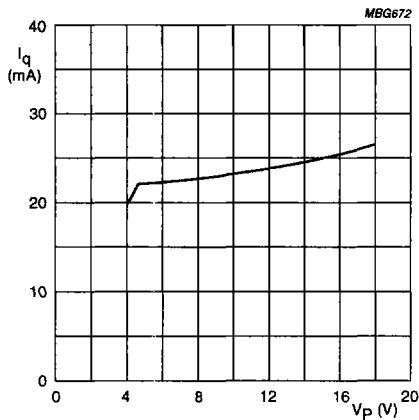
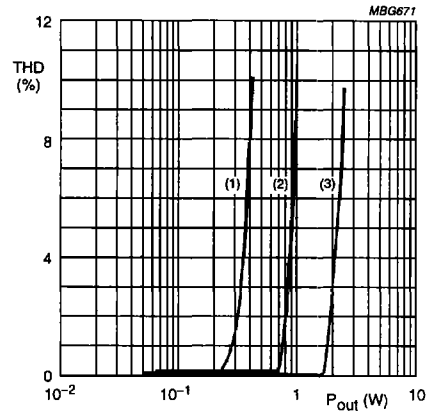
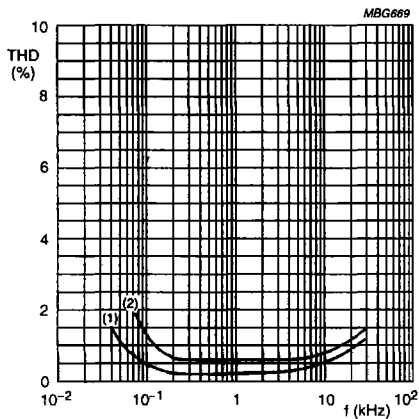

Fig.3 Quiescent current as a function of supply voltage.



- (1)  $V_P = 4.5 \text{ V}$ .
- (2)  $V_P = 6 \text{ V}; R_L = 8 \Omega$ .
- (3)  $V_P = 12 \text{ V}; R_L = 25 \Omega$ .

Fig.4 THD as a function of output power.



- (1)  $G_v = 30 \text{ dB}; P_o = 0.1 \text{ W}$ .
- (2)  $G_v = 40 \text{ dB}; P_o = 0.1 \text{ W}$ .

Fig.5 THD as a function of frequency.

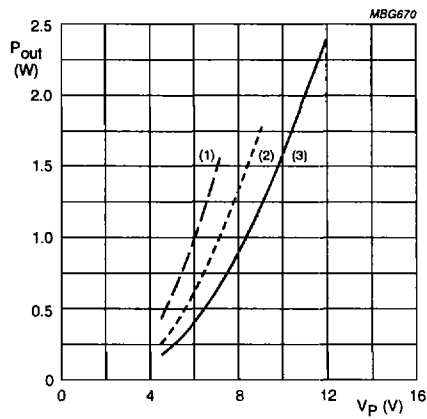

- (1)  $R_L = 8 \Omega$ .
- (2)  $R_L = 16 \Omega$ .
- (3)  $R_L = 25 \Omega$ .

Fig.6 Output power as a function of supply voltage.

# Stereo BTL audio output amplifier with DC volume control

TDA7053A

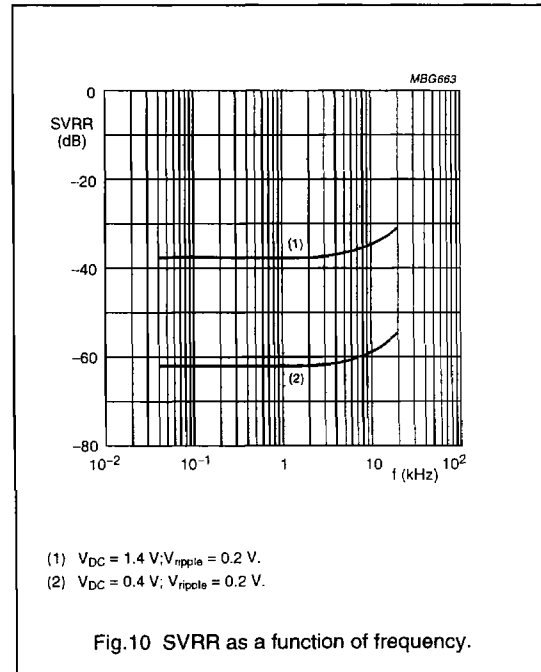
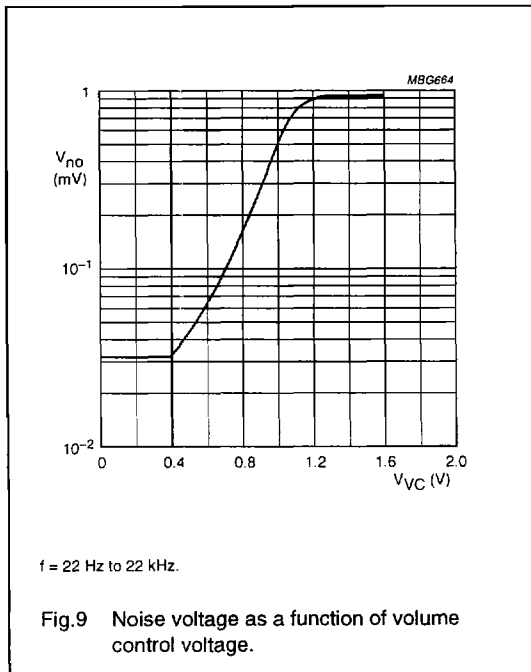
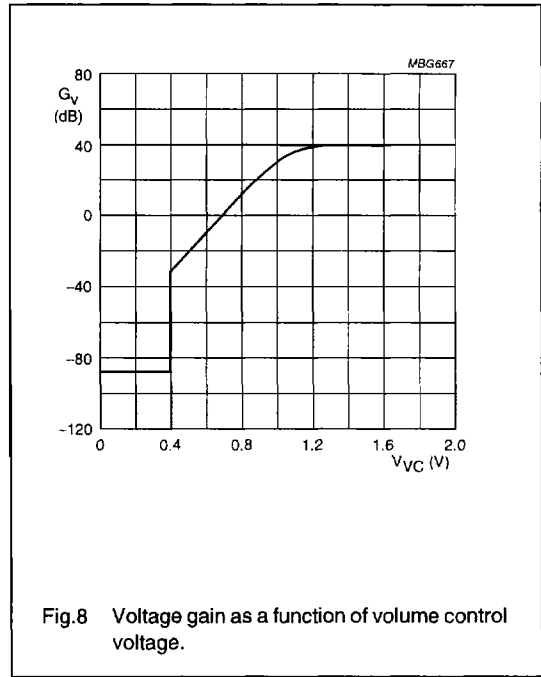
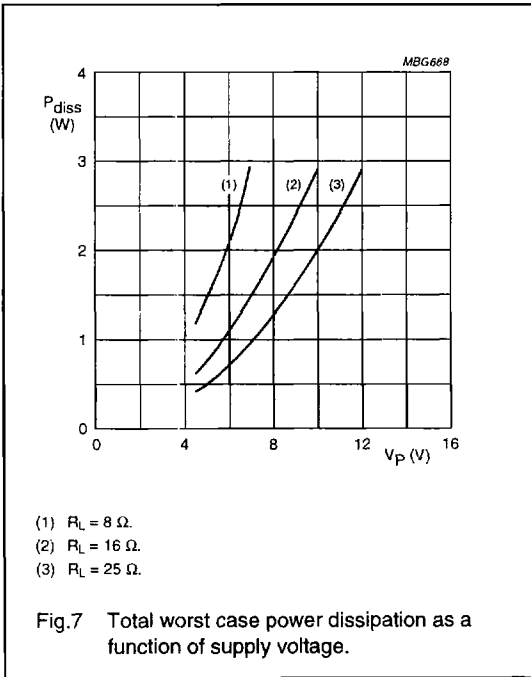

# Stereo BTL audio output amplifier with DC volume control

TDA7053A

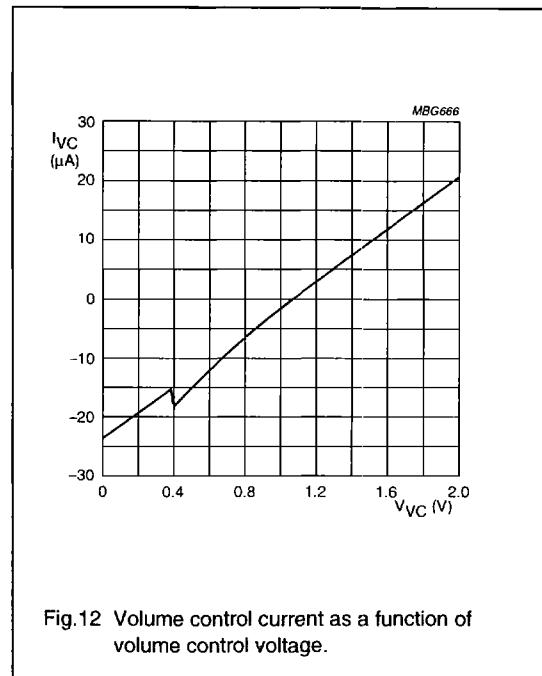
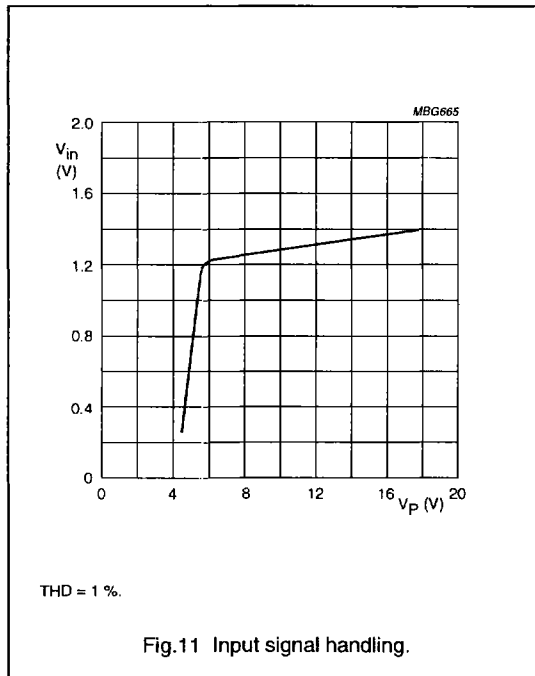

## APPLICATION INFORMATION

The application diagram is illustrated in Fig.13.

### Test conditions

$T_{amb} = 25$  °C unless otherwise specified;  $V_P = 6$  V;  
 $V_{DC} = 1.4$  V;  $f_i = 1$  kHz;  $R_L = 8$   $\Omega$ .

The quiescent current has been measured without load impedance.

The output power as a function of the supply voltage has been measured at THD = 10%. The maximum output power is limited by the maximum power dissipation and the maximum available output current.

The maximum input signal voltage is measured at THD = 1% at the output with a voltage gain of 0 dB.

To avoid instabilities and too high distortion, the input ground and power ground must be separated as far as possible and connected as close as possible to the IC.

The DC volume control can be applied in several ways. Two possible circuits are shown below the main application diagram. The circuits at the control pin will influence the switch-on and switch-off behaviour and the maximum voltage gain.

For single-end applications the output peak current must not exceed 100 mA. At higher output currents the short-circuit protection (MCL) will be active.



# Stereo BTL audio output amplifier with DC volume control

TDA7053A

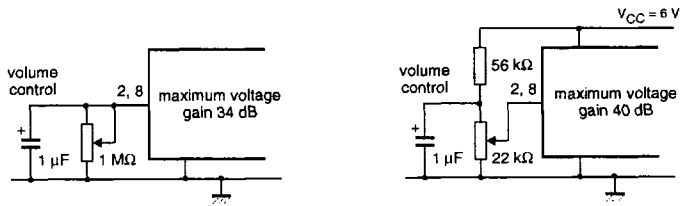
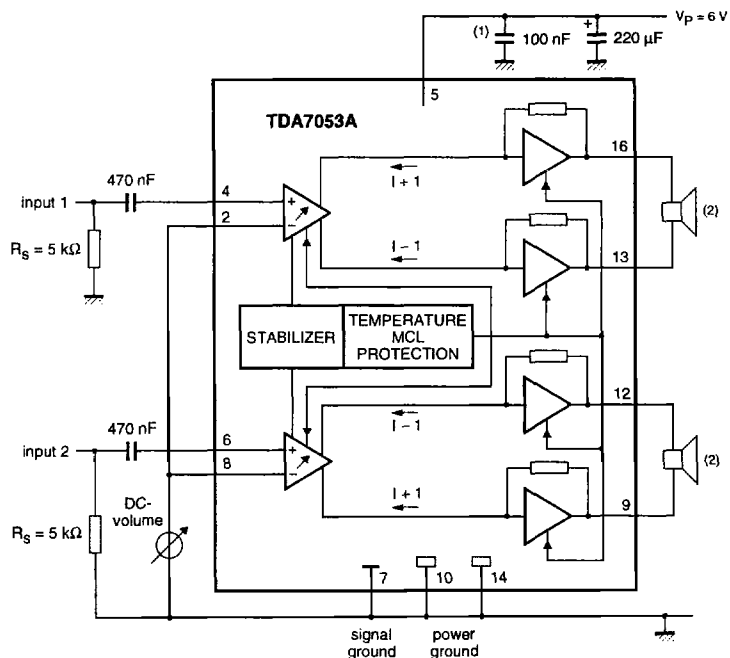

MBG673

(1) This capacitor can be omitted if the 220 μF electrolytic capacitor is connected close to pin 5.  
 (2)  $R_L = 8 \Omega$ .

Fig.13 Test and application diagram.