

SYMBOL DEFINITION		
A DIMENSION WITHOUT AN INSPECTION REPORT SYMBOL  DOES NOT REQUIRE INSPECTION. IT MAY BE CONTROLLED ON THE INDIVIDUAL COMPONENT DRAWING.	TOTAL NO OF INSPECTIONS REQUIRED	6
	LAST NO. USED	5

MISSING SYMBOLS	
NO MISSING SYMBOL NUMBER	

DWG STATUS					ZONE	REVISION HISTORY			AUTH	DR	APVD 1	APVD 2
DATE	STG	REV	N/P	CHG								
21AU00	R	001	-	-		CLEARED REV COLUMN; ALL PARTS - UPDATED PDM ATTRIBUTES			202343	AMG	PHC	RH
15MY01	R	002	-	-		ALL PARTS - REVISED CHART			209688	DS	DS	DS
060C05	R	03	-	-		ALL PARTS - ADDED CABLE ID TO CHART; 2X 2.5 WAS 2.5, 17.2 ±0.3 WAS 17.2			271935	RH	RH	TV
310C05	R	04	-	-		15305179 - REVISED REV LEVEL			274141	LMB	LMB	TV

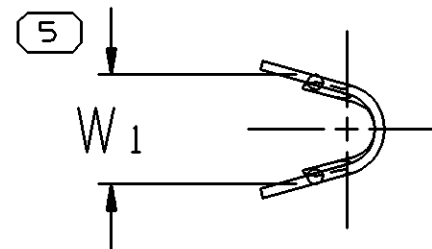

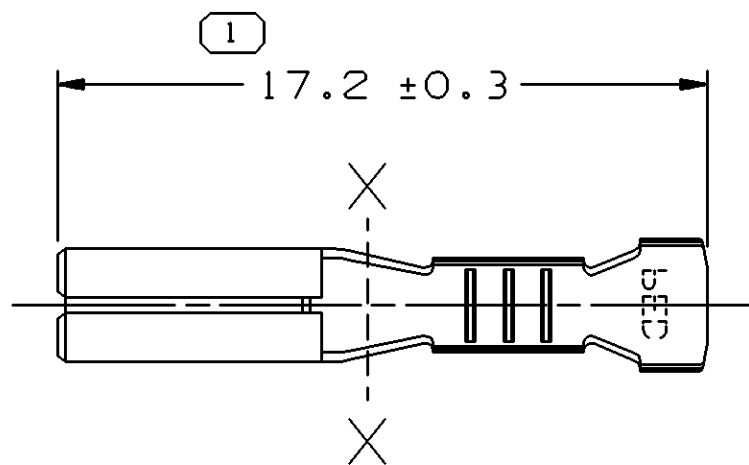
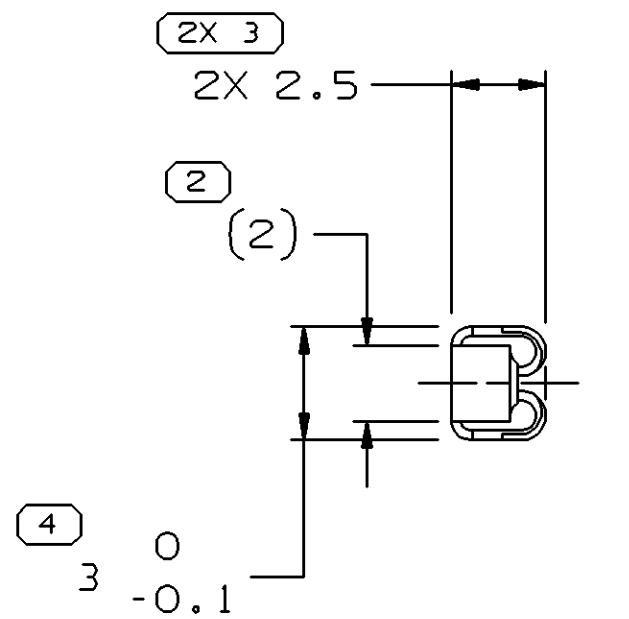

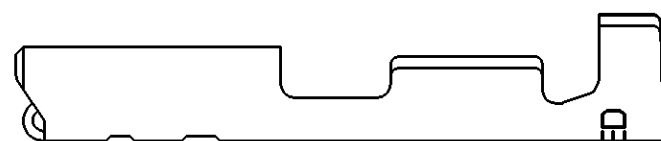
VIEW TO X-X



NOTES

- UNLESS OTHERWISE SPECIFIED AND/OR INDICATED:
DIMENSIONS ARE TO FACE OF VIEW SHOWN AND AUTOMATICALLY ROUNDED BY COMPUTER FOR INSPECTION (SEE MATH MODEL FOR PRECISE DIMENSIONS). FOR ALL OTHER DIMENSIONS NOT SHOWN BUT REQUIRED FOR TOOL BUILD, SEE MATH MODEL FOR PRECISE TOOL PATH DATA.
- REFERENCE MATING COMPONENTS OR EQUIVALENT:
TERMINAL 12045196
- TERMINAL ENGAGE FORCE 11N MAX AND CONTACT FORCE 7.8N MIN.

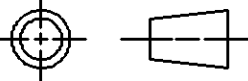
PART NO	REV	N/P	STATUS	MATERIAL SPECIFICATION	FINISH	CABLE SIZE (MM ²)	SAE WIRE SIZE NO.	CABLE I.D.	W1 ±0.3
15305181	A4	-		t0.25 ASTM2600 CDA-260	PRE-TINNED	0.35-0.5	22,20	21	2.5
15305180	A4	-		t0.25 ASTM2600 CDA-260	PRE-TINNED	0.5-1	20,18,16	16	3.4
15305179	A5	-		t0.25 ASTM2600 CDA-260	PRE-TINNED	2	14	14	3.7

DWG TYPE PART DRAWING	
STYLE	
VOLUME (CM ³)	DISTR CODE D
UNLESS OTHERWISE SPECIFIED THIS DOCUMENT IS IN ACCORDANCE WITH ASME Y14.5M-1994 AS AMENDED BY THE GM GLOBAL DIMENSIONING AND TOLERANCING ADDENDUM-2001. SEPARATE PATTERNS OF FEATURES MAY BE GAGED SEPARATELY REGARDLESS OF DATUM REFERENCES.	
ALL DIMENSIONS ARE IN MILLIMETERS	
REFERENCE	
THIRD ANGLE PROJECTION	DO NOT SCALE USE MATH DATA
	

DELPHI			
DELPHI PACKARD ELECTRIC SYSTEMS WARREN, OH			
DR			DATE
APVD1 E. LUQUENO			04SE96
APVD2 JUAN GONZALEZ			04SE96
APVD3 CHANDI RAMANI			160C96
APVD4			
APVD5			
SUBSTANCES OF CONCERN AND RECYCLED CONTENT PER DELPHI 10949001			
MATERIAL SEE CHART			
DRAWING NAME TAXI TERM F 090			
DRAWING NUMBER 12191604			
SIZE A2	SCALE 5:1	FRAME NO 1 OF 1	SHEET NO 1 OF 1
STG R	REV 04	N/P -	

4 PROCESS SENSITIVE DIMENSION	
DIMENSIONS ENCLOSED IN () INDICATE REFERENCE DIMENSIONS AND NO TOLERANCE LIMITS ARE ESTABLISHED	
DIMENSIONAL RANGE (MM)	CHART D
FROM 0	>12
TO 12	
TOLERANCE UNLESS OTHERWISE SPECIFIED	
±0.1	±0.2
ANGULAR TOLERANCE ±2°	