

## Data sheet | Item number: 857-707

Solid-state relay module; Nominal input voltage: 115 V AC/DC; Output voltage range: 0 ... 48 VDC; Limiting continuous current: 0.1 A; 2-wire connection; Yellow status indicator; Module width: 6 mm; gray

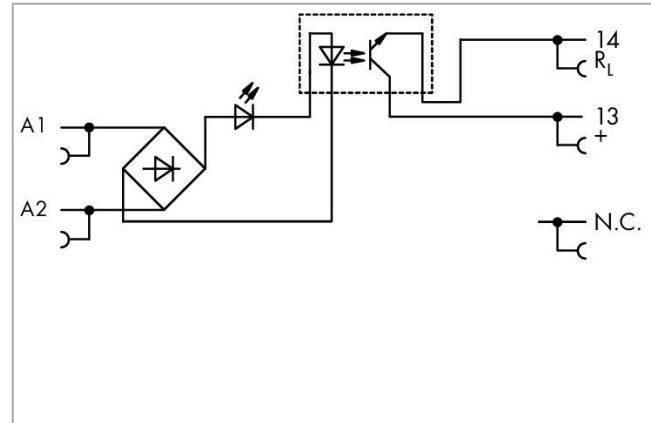

[www.wago.com/857-707](http://www.wago.com/857-707)

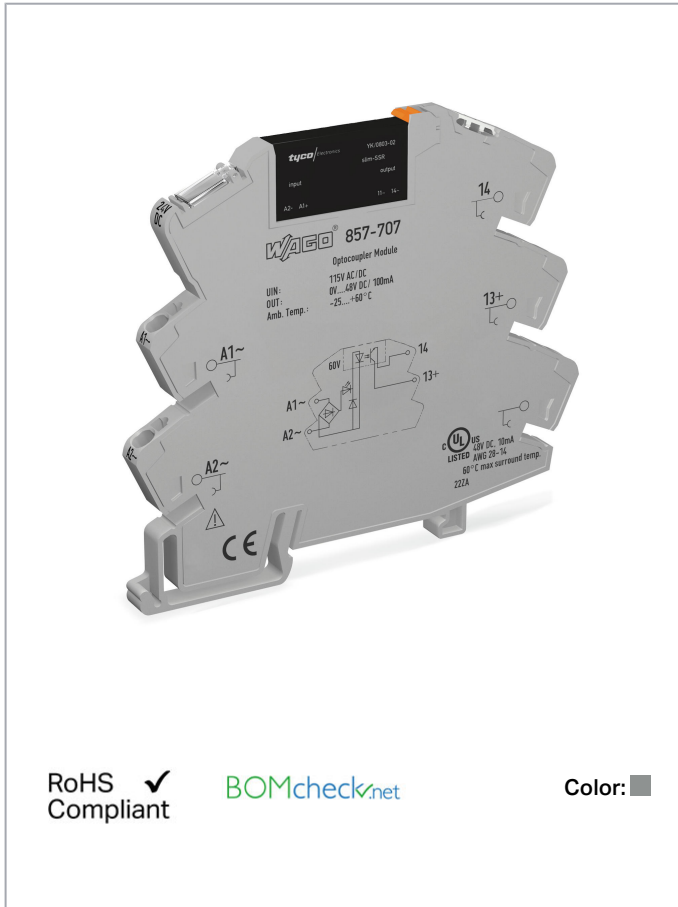

RoHS Compliant

Color:

Subject to changes. Please also observe the further product documentation!

WAGO Kontakttechnik GmbH & Co. KG  
Hansastr. 27  
32423 Minden  
Phone: +49571 887-0 | Fax: +49571 887-169  
Email: [info.de@wago.com](mailto:info.de@wago.com) | Web: [www.wago.com](http://www.wago.com)

Do you have any questions about our products?  
We are always happy to take your call at +49 (571) 887-44222.

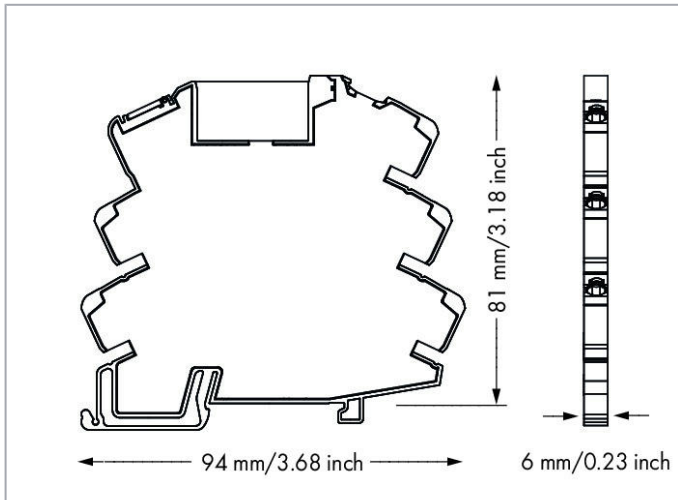

## Item description

### Note:

Optocouplers and solid state relays are designed for use in signal processing networks, which are not supplied by the low-voltage power supply networks.

## Data

### Technical Data

#### Control circuit

Nominal input voltage $U_N$	AC/DC 115 V (SELV)
Input voltage range (low level)	AC/DC 0 ... 25 V
Input voltage range (high level)	AC/DC 100 ... 138 V
Nominal input current at $U_N$	4.2 mA

#### Load circuit

Circuit type	2-wire connection
Limiting continuous current	0.1 A
Nominal output voltage	DC 24 V
Output voltage range	DC 0 ... 48 V
Voltage drop at output (max.)	$\leq$ DC 1 V
Leakage current at rated voltage	$\leq$ 1 $\mu$ A
Switching current (min.)	50 $\mu$ A
Turn-on time	$\leq$ 4.5 ms

Subject to changes. Please also observe the further product documentation!



Turn-off time	≤ 10 ms
Switching frequency	≤ 20 Hz

### Signaling

Status indicator	Yellow LED
------------------	------------

### Safety and protection

Dielectric strength, control/load circuit (AC, 1 min)	3.75 kVrms
Protection type	IP20

### Connection data

Connection technology	Push-in CAGE CLAMP®
Solid conductor	0.34 ... 2.5 mm <sup>2</sup> / 22 ... 14 AWG
Fine-stranded conductor	0.34 ... 2.5 mm <sup>2</sup> / 22 ... 14 AWG
Strip length	9 ... 10 mm / 0.35 ... 0.39 inch

### Physical data

Width	6 mm / 0.236 inch
Height from upper-edge of DIN-rail	81 mm / 3.189 inch
Depth	94 mm / 3.701 inch

### Mechanical data

Mounting type	DIN-35 rail
---------------	-------------

### Material Data

Color	gray
Fire load	0.011 MJ
Weight	30 g

### Environmental Requirements

Surrounding air temperature (operation at $U_N$ )	-20 ... 60 °C
Surrounding air temperature (storage)	-40 ... 70 °C
Processing temperature	-25 ... +50 °C

Subject to changes. Please also observe the further product documentation!

## Standards and specifications

Standards/specifications

EN 61000-6-2; EN 61000-6-3; EN 61373; EN 61010-2-201; UL 508

## Basic relay

WAGO Basic Relay

857-165

## Commercial data

Product Group

6 (Interface Electronics)

Packaging type

BOX

Country of origin

DE

GTIN



4045454835507

Customs tariff number

85365005000

## Approvals / Certificates

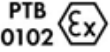
### Ex-Approvals

Logo	Approval	Additional Approval Text	Certificate name
	ATEX DEKRA EXAM GmbH	EN 60079-0	BVS_14_ATEX_E_091_X
	IECEX DEKRA EXAM GmbH	IEC 60079-0	IECEX_BVS_14.0079_X

### UL-Approvals

Logo	Approval	Additional Approval Text	Certificate name
	UL UL International Netherlands B.V. (ORDINARY LOCATIONS)	UL 508	E175199 Sec.4

## Counterpart

Subject to changes. Please also observe the further product documentation!

WAGO Kontakttechnik GmbH & Co. KG

Hansastr. 27

32423 Minden

Phone: +49571 887-0 | Fax: +49571 887-169



Email: [info.de@wago.com](mailto:info.de@wago.com) | Web: [www.wago.com](http://www.wago.com)

Do you have any questions about our products?











We are always happy to take your call at +49 (571) 887-44222.

## Compatible products















### General accessories

	<b>Item no.: 209-184</b> Protection cover; transparent	<a href="http://www.wago.com/209-184">www.wago.com/209-184</a>
	<b>Item no.: 857-165</b> Basic solid-state relay; Nominal input voltage: 60 VDC; Output voltage range: 0 ... 48 VDC	<a href="http://www.wago.com/857-165">www.wago.com/857-165</a>

### Marking accessories

	<b>Item no.: 2009-110</b> Marking strips; for Smart Printer; on reel; not stretchable; plain; snap-on type; white	<a href="http://www.wago.com/2009-110">www.wago.com/2009-110</a>
	<b>Item no.: 2009-115</b> WMB-Inline; for Smart Printer; 1500 pieces on roll; stretchable 5 - 5.2 mm; plain; snap-on type; white	<a href="http://www.wago.com/2009-115">www.wago.com/2009-115</a>
	<b>Item no.: 2009-115/000-002</b> WMB-Inline; for Smart Printer; 1500 pieces on roll; stretchable 5 - 5.2 mm; plain; snap-on type; yellow	<a href="http://www.wago.com/2009-115/000-002">www.wago.com/2009-115/000-002</a>
	<b>Item no.: 2009-115/000-006</b> WMB-Inline; for Smart Printer; 1500 pieces on roll; stretchable 5 - 5.2 mm; plain; snap-on type; blue	<a href="http://www.wago.com/2009-115/000-006">www.wago.com/2009-115/000-006</a>
	<b>Item no.: 2009-115/000-007</b> WMB-Inline; for Smart Printer; 1500 pieces on roll; stretchable 5 - 5.2 mm; plain; snap-on type; gray	<a href="http://www.wago.com/2009-115/000-007">www.wago.com/2009-115/000-007</a>
	<b>Item no.: 2009-115/000-012</b> WMB-Inline; for Smart Printer; 1500 pieces on roll; stretchable 5 - 5.2 mm; plain; snap-on type; orange	<a href="http://www.wago.com/2009-115/000-012">www.wago.com/2009-115/000-012</a>
	<b>Item no.: 2009-115/000-017</b> WMB-Inline; for Smart Printer; 1500 pieces on roll; stretchable 5 - 5.2 mm; plain; snap-on type; light green	<a href="http://www.wago.com/2009-115/000-017">www.wago.com/2009-115/000-017</a>
	<b>Item no.: 2009-115/000-023</b> WMB-Inline; for Smart Printer; 1500 pieces on roll; stretchable 5 - 5.2 mm; plain; snap-on type; green	<a href="http://www.wago.com/2009-115/000-023">www.wago.com/2009-115/000-023</a>
	<b>Item no.: 2009-115/000-024</b> WMB-Inline; for Smart Printer; 1500 pieces on roll; stretchable 5 - 5.2 mm; plain; snap-on type; violet	<a href="http://www.wago.com/2009-115/000-024">www.wago.com/2009-115/000-024</a>
	<b>Item no.: 209-128</b> Adaptor; gray	<a href="http://www.wago.com/209-128">www.wago.com/209-128</a>

Subject to changes. Please also observe the further product documentation!

	<b>Item no.: 209-183</b> Marker card; white	<a href="http://www.wago.com/209-183">www.wago.com/209-183</a>
	<b>Item no.: 210-110</b> Fiber-tip pen	<a href="http://www.wago.com/210-110">www.wago.com/210-110</a>
	<b>Item no.: 249-105</b> Group marker carrier; gray	<a href="http://www.wago.com/249-105">www.wago.com/249-105</a>
	<b>Item no.: 793-501</b> WMB marking card; as card; not stretchable; plain; snap-on type; white	<a href="http://www.wago.com/793-501">www.wago.com/793-501</a>
	<b>Item no.: 793-501/000-002</b> WMB marking card; as card; not stretchable; plain; snap-on type; yellow	<a href="http://www.wago.com/793-501/000-002">www.wago.com/793-501/000-002</a>
	<b>Item no.: 793-501/000-005</b> WMB marking card; as card; not stretchable; plain; snap-on type; red	<a href="http://www.wago.com/793-501/000-005">www.wago.com/793-501/000-005</a>
	<b>Item no.: 793-501/000-006</b> WMB marking card; as card; not stretchable; plain; snap-on type; blue	<a href="http://www.wago.com/793-501/000-006">www.wago.com/793-501/000-006</a>
	<b>Item no.: 793-501/000-007</b> WMB marking card; as card; not stretchable; plain; snap-on type; gray	<a href="http://www.wago.com/793-501/000-007">www.wago.com/793-501/000-007</a>
	<b>Item no.: 793-501/000-012</b> WMB marking card; as card; not stretchable; plain; snap-on type; orange	<a href="http://www.wago.com/793-501/000-012">www.wago.com/793-501/000-012</a>
	<b>Item no.: 793-501/000-017</b> WMB marking card; as card; not stretchable; plain; snap-on type; light green	<a href="http://www.wago.com/793-501/000-017">www.wago.com/793-501/000-017</a>
	<b>Item no.: 793-501/000-023</b> WMB marking card; as card; not stretchable; plain; snap-on type; green	<a href="http://www.wago.com/793-501/000-023">www.wago.com/793-501/000-023</a>
	<b>Item no.: 793-501/000-024</b> WMB marking card; as card; not stretchable; plain; snap-on type; violet	<a href="http://www.wago.com/793-501/000-024">www.wago.com/793-501/000-024</a>
	<b>Item no.: 793-502</b> WMB marking card; as card; MARKED; 1 ... 10 (10x); not stretchable; Horizontal marking; snap-on type; white	<a href="http://www.wago.com/793-502">www.wago.com/793-502</a>
	<b>Item no.: 793-502/000-002</b> WMB marking card; as card; MARKED; 1 ... 10 (10x); not stretchable; Horizontal marking; snap-on type; yellow	<a href="http://www.wago.com/793-502/000-002">www.wago.com/793-502/000-002</a>
	<b>Item no.: 793-502/000-005</b>	

Subject to changes. Please also observe the further product documentation!



WMB marking card; as card; MARKED; 1 ... 10 (10x); not stretchable; Horizontal marking; snap-on type; red

[www.wago.com/793-502/000-005](http://www.wago.com/793-502/000-005)



**Item no.: 793-502/000-006**

WMB marking card; as card; MARKED; 1 ... 10 (10x); not stretchable; Horizontal marking; snap-on type; blue

[www.wago.com/793-502/000-006](http://www.wago.com/793-502/000-006)



**Item no.: 793-502/000-007**

WMB marking card; as card; MARKED; 1 ... 10 (10x); not stretchable; Horizontal marking; snap-on type; gray

[www.wago.com/793-502/000-007](http://www.wago.com/793-502/000-007)



**Item no.: 793-502/000-012**

WMB marking card; as card; MARKED; 1 ... 10 (10x); not stretchable; Horizontal marking; snap-on type; orange

[www.wago.com/793-502/000-012](http://www.wago.com/793-502/000-012)



**Item no.: 793-502/000-017**

WMB marking card; as card; MARKED; 1 ... 10 (10x); not stretchable; Horizontal marking; snap-on type; light green

[www.wago.com/793-502/000-017](http://www.wago.com/793-502/000-017)



**Item no.: 793-502/000-023**

WMB marking card; as card; MARKED; 1 ... 10 (10x); not stretchable; Horizontal marking; snap-on type; green

[www.wago.com/793-502/000-023](http://www.wago.com/793-502/000-023)



**Item no.: 793-502/000-024**

WMB marking card; as card; MARKED; 1 ... 10 (10x); not stretchable; Horizontal marking; snap-on type; violet

[www.wago.com/793-502/000-024](http://www.wago.com/793-502/000-024)



**Item no.: 793-503**

WMB marking card; as card; MARKED; 11 ... 20 (10x); not stretchable; Horizontal marking; snap-on type; white

[www.wago.com/793-503](http://www.wago.com/793-503)



**Item no.: 793-503/000-002**

WMB marking card; as card; MARKED; 11 ... 20 (10x); not stretchable; Horizontal marking; snap-on type; yellow

[www.wago.com/793-503/000-002](http://www.wago.com/793-503/000-002)



**Item no.: 793-503/000-005**

WMB marking card; as card; MARKED; 11 ... 20 (10x); not stretchable; Horizontal marking; snap-on type; red

[www.wago.com/793-503/000-005](http://www.wago.com/793-503/000-005)



**Item no.: 793-503/000-006**

WMB marking card; as card; MARKED; 11 ... 20 (10x); not stretchable; Horizontal marking; snap-on type; blue

[www.wago.com/793-503/000-006](http://www.wago.com/793-503/000-006)



**Item no.: 793-503/000-007**

WMB marking card; as card; MARKED; 11 ... 20 (10x); not stretchable; Horizontal marking; snap-on type; gray

[www.wago.com/793-503/000-007](http://www.wago.com/793-503/000-007)



**Item no.: 793-503/000-012**

WMB marking card; as card; MARKED; 11 ... 20 (10x); not stretchable; Horizontal marking; snap-on type; orange

[www.wago.com/793-503/000-012](http://www.wago.com/793-503/000-012)

**Item no.: 793-503/000-017**

Subject to changes. Please also observe the further product documentation!

WAGO Kontakttechnik GmbH & Co. KG

Hansastr. 27

32423 Minden

Phone: +49571 887-0 | Fax: +49571 887-169

Email: [info.de@wago.com](mailto:info.de@wago.com) | Web: [www.wago.com](http://www.wago.com)

Do you have any questions about our products?

We are always happy to take your call at +49 (571) 887-44222.



WMB marking card; as card; MARKED; 11 ... 20 (10x); not stretchable; Horizontal marking; snap-on type; light green

[www.wago.com/793-503/000-017](http://www.wago.com/793-503/000-017)



**Item no.: 793-503/000-023**

WMB marking card; as card; MARKED; 11 ... 20 (10x); not stretchable; Horizontal marking; snap-on type; green

[www.wago.com/793-503/000-023](http://www.wago.com/793-503/000-023)



**Item no.: 793-503/000-024**

WMB marking card; as card; MARKED; 11 ... 20 (10x); not stretchable; Horizontal marking; snap-on type; violet

[www.wago.com/793-503/000-024](http://www.wago.com/793-503/000-024)



**Item no.: 793-504**

WMB marking card; as card; MARKED; 21 ... 30 (10x); not stretchable; Horizontal marking; snap-on type; white

[www.wago.com/793-504](http://www.wago.com/793-504)



**Item no.: 793-504/000-002**

WMB marking card; as card; MARKED; 21 ... 30 (10x); not stretchable; Horizontal marking; snap-on type; yellow

[www.wago.com/793-504/000-002](http://www.wago.com/793-504/000-002)



**Item no.: 793-504/000-005**

WMB marking card; as card; MARKED; 21 ... 30 (10x); not stretchable; Horizontal marking; snap-on type; red

[www.wago.com/793-504/000-005](http://www.wago.com/793-504/000-005)



**Item no.: 793-504/000-006**

WMB marking card; as card; MARKED; 21 ... 30 (10x); not stretchable; Horizontal marking; snap-on type; blue

[www.wago.com/793-504/000-006](http://www.wago.com/793-504/000-006)



**Item no.: 793-504/000-012**

WMB marking card; as card; MARKED; 21 ... 30 (10x); not stretchable; Horizontal marking; snap-on type; orange

[www.wago.com/793-504/000-012](http://www.wago.com/793-504/000-012)



**Item no.: 793-504/000-017**

WMB marking card; as card; MARKED; 21 ... 30 (10x); not stretchable; Horizontal marking; snap-on type; light green

[www.wago.com/793-504/000-017](http://www.wago.com/793-504/000-017)



**Item no.: 793-504/000-023**

WMB marking card; as card; MARKED; 21 ... 30 (10x); not stretchable; Horizontal marking; snap-on type; green

[www.wago.com/793-504/000-023](http://www.wago.com/793-504/000-023)



**Item no.: 793-505**

WMB marking card; as card; MARKED; 31 ... 40 (10x); not stretchable; Horizontal marking; snap-on type; white

[www.wago.com/793-505](http://www.wago.com/793-505)



**Item no.: 793-505/000-005**

WMB marking card; as card; MARKED; 31 ... 40 (10x); not stretchable; Horizontal marking; snap-on type; red

[www.wago.com/793-505/000-005](http://www.wago.com/793-505/000-005)



**Item no.: 793-505/000-006**

WMB marking card; as card; MARKED; 31 ... 40 (10x); not stretchable; Horizontal marking; snap-on type; blue

[www.wago.com/793-505/000-006](http://www.wago.com/793-505/000-006)

**Item no.: 793-505/000-007**

WMB marking card; as card; MARKED; 31 ... 40 (10x); not stretchable; Horizontal marking; snap-on type;

Subject to changes. Please also observe the further product documentation!



gray

[www.wago.com/793-505/000-007](http://www.wago.com/793-505/000-007)



**Item no.: 793-505/000-012**

WMB marking card; as card; MARKED; 31 ... 40 (10x); not stretchable; Horizontal marking; snap-on type; orange

[www.wago.com/793-505/000-012](http://www.wago.com/793-505/000-012)



**Item no.: 793-506**

WMB marking card; as card; MARKED; 41 ... 50 (10x); not stretchable; Horizontal marking; snap-on type; white

[www.wago.com/793-506](http://www.wago.com/793-506)



**Item no.: 793-506/000-005**

WMB marking card; as card; MARKED; 41 ... 50 (10x); not stretchable; Horizontal marking; snap-on type; red

[www.wago.com/793-506/000-005](http://www.wago.com/793-506/000-005)



**Item no.: 793-506/000-006**

WMB marking card; as card; MARKED; 41 ... 50 (10x); not stretchable; Horizontal marking; snap-on type; blue

[www.wago.com/793-506/000-006](http://www.wago.com/793-506/000-006)



**Item no.: 793-506/000-012**

WMB marking card; as card; MARKED; 41 ... 50 (10x); not stretchable; Horizontal marking; snap-on type; orange

[www.wago.com/793-506/000-012](http://www.wago.com/793-506/000-012)



**Item no.: 793-506/000-017**

WMB marking card; as card; MARKED; 41 ... 50 (10x); not stretchable; Horizontal marking; snap-on type; light green

[www.wago.com/793-506/000-017](http://www.wago.com/793-506/000-017)



**Item no.: 793-5501**

WMB marking card; as card; for terminal block width 5 - 17.5 mm; stretchable 5 - 5.2 mm; plain; snap-on type; white

[www.wago.com/793-5501](http://www.wago.com/793-5501)



**Item no.: 793-5501/000-002**

WMB marking card; as card; for terminal block width 5 - 17.5 mm; stretchable 5 - 5.2 mm; plain; snap-on type; yellow

[www.wago.com/793-5501/000-002](http://www.wago.com/793-5501/000-002)



**Item no.: 793-5501/000-005**

WMB marking card; as card; for terminal block width 5 - 17.5 mm; stretchable 5 - 5.2 mm; plain; snap-on type; red

[www.wago.com/793-5501/000-005](http://www.wago.com/793-5501/000-005)



**Item no.: 793-5501/000-006**

WMB marking card; as card; for terminal block width 5 - 17.5 mm; stretchable 5 - 5.2 mm; plain; snap-on type; blue

[www.wago.com/793-5501/000-006](http://www.wago.com/793-5501/000-006)



**Item no.: 793-5501/000-007**

WMB marking card; as card; for terminal block width 5 - 17.5 mm; stretchable 5 - 5.2 mm; plain; snap-on type; gray

[www.wago.com/793-5501/000-007](http://www.wago.com/793-5501/000-007)



**Item no.: 793-5501/000-012**













WMB marking card; as card; for terminal block width 5 - 17.5 mm; stretchable 5 - 5.2 mm; plain; snap-on type; orange

[www.wago.com/793-5501/000-012](http://www.wago.com/793-5501/000-012)

**Item no.: 793-5501/000-014**

WMB marking card; as card; for terminal block width 5 - 17.5 mm; stretchable 5 - 5.2 mm; plain; snap-on

Subject to changes. Please also observe the further product documentation!

	type; brown	<a href="http://www.wago.com/793-5501/000-014">www.wago.com/793-5501/000-014</a>
	<b>Item no.: 793-5501/000-017</b> WMB marking card; as card; for terminal block width 5 - 17.5 mm; stretchable 5 - 5.2 mm; plain; snap-on type; green	<a href="http://www.wago.com/793-5501/000-017">www.wago.com/793-5501/000-017</a>
	<b>Item no.: 793-5501/000-023</b> WMB marking card; as card; for terminal block width 5 - 17.5 mm; stretchable 5 - 5.2 mm; plain; snap-on type; light green	<a href="http://www.wago.com/793-5501/000-023">www.wago.com/793-5501/000-023</a>
	<b>Item no.: 793-5501/000-024</b> WMB marking card; as card; for terminal block width 5 - 17.5 mm; stretchable 5 - 5.2 mm; plain; snap-on type; violet	<a href="http://www.wago.com/793-5501/000-024">www.wago.com/793-5501/000-024</a>
	<b>Item no.: 793-566</b> WMB marking card; as card; MARKED; 1 ... 50 (2x); not stretchable; Horizontal marking; snap-on type; white	<a href="http://www.wago.com/793-566">www.wago.com/793-566</a>
	<b>Item no.: 793-566/000-002</b> WMB marking card; as card; MARKED; 1 ... 50 (2x); not stretchable; Horizontal marking; snap-on type; yellow	<a href="http://www.wago.com/793-566/000-002">www.wago.com/793-566/000-002</a>
	<b>Item no.: 793-566/000-005</b> WMB marking card; as card; MARKED; 1 ... 50 (2x); not stretchable; Horizontal marking; snap-on type; red	<a href="http://www.wago.com/793-566/000-005">www.wago.com/793-566/000-005</a>
	<b>Item no.: 793-566/000-006</b> WMB marking card; as card; MARKED; 1 ... 50 (2x); not stretchable; Horizontal marking; snap-on type; blue	<a href="http://www.wago.com/793-566/000-006">www.wago.com/793-566/000-006</a>
	<b>Item no.: 793-566/000-007</b> WMB marking card; as card; MARKED; 1 ... 50 (2x); not stretchable; Horizontal marking; snap-on type; gray	<a href="http://www.wago.com/793-566/000-007">www.wago.com/793-566/000-007</a>
	<b>Item no.: 793-566/000-012</b> WMB marking card; as card; MARKED; 1 ... 50 (2x); not stretchable; Horizontal marking; snap-on type; orange	<a href="http://www.wago.com/793-566/000-012">www.wago.com/793-566/000-012</a>
	<b>Item no.: 793-566/000-017</b> WMB marking card; as card; MARKED; 1 ... 50 (2x); not stretchable; Horizontal marking; snap-on type; light green	<a href="http://www.wago.com/793-566/000-017">www.wago.com/793-566/000-017</a>
	<b>Item no.: 793-566/000-023</b> WMB marking card; as card; MARKED; 1 ... 50 (2x); not stretchable; Horizontal marking; snap-on type; green	<a href="http://www.wago.com/793-566/000-023">www.wago.com/793-566/000-023</a>
	<b>Item no.: 793-566/000-024</b> WMB marking card; as card; MARKED; 1 ... 50 (2x); not stretchable; Horizontal marking; snap-on type; violet	<a href="http://www.wago.com/793-566/000-024">www.wago.com/793-566/000-024</a>

#### tools

Subject to changes. Please also observe the further product documentation!

**Item no.: 210-720**

Operating tool; Blade: 3.5 x 0.5 mm; with a partially insulated shaft

[www.wago.com/210-720](http://www.wago.com/210-720)**ferrule****Item no.: 216-241**Ferrule; Sleeve for 0.5 mm<sup>2</sup> / 20 AWG; insulated; electro-tin plated; electrolytic copper; gastight crimped; acc. to DIN 46228, Part 4/09.90; white[www.wago.com/216-241](http://www.wago.com/216-241)**Item no.: 216-242**Ferrule; Sleeve for 0.75 mm<sup>2</sup> / 18 AWG; insulated; electro-tin plated; electrolytic copper; gastight crimped; acc. to DIN 46228, Part 4/09.90; gray[www.wago.com/216-242](http://www.wago.com/216-242)**Item no.: 216-243**Ferrule; Sleeve for 1 mm<sup>2</sup> / AWG 18; insulated; electro-tin plated; electrolytic copper; gastight crimped; acc. to DIN 46228, Part 4/09.90; red[www.wago.com/216-243](http://www.wago.com/216-243)**Item no.: 216-244**Ferrule; Sleeve for 1.5 mm<sup>2</sup> / AWG 16; insulated; electro-tin plated; electrolytic copper; gastight crimped; acc. to DIN 46228, Part 4/09.90; black[www.wago.com/216-244](http://www.wago.com/216-244)**Jumper****Item no.: 281-482**

Jumper; insulated; gray

[www.wago.com/281-482](http://www.wago.com/281-482)**Item no.: 859-402**

Jumper; for jumper slot; 2-way; insulated; light gray

[www.wago.com/859-402](http://www.wago.com/859-402)**Item no.: 859-402/000-005**

Jumper; for jumper slot; 2-way; insulated; red

[www.wago.com/859-402/000-005](http://www.wago.com/859-402/000-005)**Item no.: 859-402/000-006**

Jumper; for jumper slot; 2-way; insulated; blue

[www.wago.com/859-402/000-006](http://www.wago.com/859-402/000-006)**Item no.: 859-402/000-029**

Jumper; for jumper slot; 2-way; insulated; yellow

[www.wago.com/859-402/000-029](http://www.wago.com/859-402/000-029)**Item no.: 859-403**

Jumper; for jumper slot; 3-way; insulated; light gray

[www.wago.com/859-403](http://www.wago.com/859-403)**Item no.: 859-403/000-005**

Jumper; for jumper slot; 3-way; insulated; red

[www.wago.com/859-403/000-005](http://www.wago.com/859-403/000-005)**Item no.: 859-403/000-006**

Jumper; for jumper slot; 3-way; insulated; blue

[www.wago.com/859-403/000-006](http://www.wago.com/859-403/000-006)**Item no.: 859-403/000-029**

Jumper; for jumper slot; 3-way; insulated; yellow

[www.wago.com/859-403/000-029](http://www.wago.com/859-403/000-029)

Subject to changes. Please also observe the further product documentation!

WAGO Kontakttechnik GmbH &amp; Co. KG

Hansastr. 27







32423 Minden

Phone: +49571 887-0 | Fax: +49571 887-169

Email: [info.de@wago.com](mailto:info.de@wago.com) | Web: [www.wago.com](http://www.wago.com)

Do you have any questions about our products?

We are always happy to take your call at +49 (571) 887-44222.

	<b>Item no.: 859-404</b> Jumper; for jumper slot; 4-way; insulated; light gray	<a href="http://www.wago.com/859-404">www.wago.com/859-404</a>
	<b>Item no.: 859-404/000-005</b> Jumper; for jumper slot; 4-way; insulated; red	<a href="http://www.wago.com/859-404/000-005">www.wago.com/859-404/000-005</a>
	<b>Item no.: 859-404/000-006</b> Jumper; for jumper slot; 4-way; insulated; blue	<a href="http://www.wago.com/859-404/000-006">www.wago.com/859-404/000-006</a>
	<b>Item no.: 859-404/000-029</b> Jumper; for jumper slot; 4-way; insulated; yellow	<a href="http://www.wago.com/859-404/000-029">www.wago.com/859-404/000-029</a>
	<b>Item no.: 859-405</b> Jumper; for jumper slot; 5-way; insulated; light gray	<a href="http://www.wago.com/859-405">www.wago.com/859-405</a>
	<b>Item no.: 859-405/000-005</b> Jumper; for jumper slot; 5-way; insulated; red	<a href="http://www.wago.com/859-405/000-005">www.wago.com/859-405/000-005</a>
	<b>Item no.: 859-405/000-006</b> Jumper; for jumper slot; 5-way; insulated; blue	<a href="http://www.wago.com/859-405/000-006">www.wago.com/859-405/000-006</a>
	<b>Item no.: 859-405/000-029</b> Jumper; for jumper slot; 5-way; insulated; yellow	<a href="http://www.wago.com/859-405/000-029">www.wago.com/859-405/000-029</a>
	<b>Item no.: 859-406</b> Jumper; for jumper slot; 6-way; insulated; light gray	<a href="http://www.wago.com/859-406">www.wago.com/859-406</a>
	<b>Item no.: 859-406/000-005</b> Jumper; for jumper slot; 6-way; insulated; red	<a href="http://www.wago.com/859-406/000-005">www.wago.com/859-406/000-005</a>
	<b>Item no.: 859-406/000-006</b> Jumper; for jumper slot; 6-way; insulated; blue	<a href="http://www.wago.com/859-406/000-006">www.wago.com/859-406/000-006</a>
	<b>Item no.: 859-406/000-029</b> Jumper; for jumper slot; 6-way; insulated; signal yellow	<a href="http://www.wago.com/859-406/000-029">www.wago.com/859-406/000-029</a>
	<b>Item no.: 859-407</b> Jumper; for jumper slot; 7-way; insulated; light gray	<a href="http://www.wago.com/859-407">www.wago.com/859-407</a>
	<b>Item no.: 859-407/000-005</b> Jumper; for jumper slot; 7-way; insulated; red	<a href="http://www.wago.com/859-407/000-005">www.wago.com/859-407/000-005</a>

Subject to changes. Please also observe the further product documentation!



**Item no.: 859-407/000-006**  
Jumper; for jumper slot; 7-way; insulated; blue

[www.wago.com/859-407/000-006](http://www.wago.com/859-407/000-006)



**Item no.: 859-407/000-029**  
Jumper; for jumper slot; 7-way; insulated; yellow

[www.wago.com/859-407/000-029](http://www.wago.com/859-407/000-029)



**Item no.: 859-408**  
Jumper; for jumper slot; 8-way; insulated; light gray

[www.wago.com/859-408](http://www.wago.com/859-408)



**Item no.: 859-408/000-005**  
Jumper; for jumper slot; 8-way; insulated; red

[www.wago.com/859-408/000-005](http://www.wago.com/859-408/000-005)



**Item no.: 859-408/000-006**  
Jumper; for jumper slot; 8-way; insulated; blue

[www.wago.com/859-408/000-006](http://www.wago.com/859-408/000-006)



**Item no.: 859-408/000-029**  
Jumper; for jumper slot; 8-way; insulated; yellow

[www.wago.com/859-408/000-029](http://www.wago.com/859-408/000-029)



**Item no.: 859-409**  
Jumper; for jumper slot; 9-way; insulated; light gray

[www.wago.com/859-409](http://www.wago.com/859-409)



**Item no.: 859-409/000-005**  
Jumper; for jumper slot; 9-way; insulated; red

[www.wago.com/859-409/000-005](http://www.wago.com/859-409/000-005)



**Item no.: 859-409/000-006**  
Jumper; for jumper slot; 9-way; insulated; blue

[www.wago.com/859-409/000-006](http://www.wago.com/859-409/000-006)



**Item no.: 859-409/000-029**  
Jumper; for jumper slot; 9-way; insulated; yellow

[www.wago.com/859-409/000-029](http://www.wago.com/859-409/000-029)



**Item no.: 859-410**  
Jumper; for jumper slot; 10-way; insulated; light gray

[www.wago.com/859-410](http://www.wago.com/859-410)



**Item no.: 859-410/000-005**  
Jumper; for jumper slot; 10-way; insulated; red

[www.wago.com/859-410/000-005](http://www.wago.com/859-410/000-005)

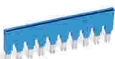

**Item no.: 859-410/000-006**  
Jumper; for jumper slot; 10-way; insulated; blue

[www.wago.com/859-410/000-006](http://www.wago.com/859-410/000-006)

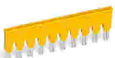

**Item no.: 859-410/000-029**  
Jumper; for jumper slot; 10-way; insulated; yellow

[www.wago.com/859-410/000-029](http://www.wago.com/859-410/000-029)

Subject to changes. Please also observe the further product documentation!



## Downloads

### Documentation

#### Bid Text

857-707 GAEB docx - Datei	Feb 20, 2019	docx 16.4 kB	Download
------------------------------	--------------	-----------------	----------

857-707 GAEB X81 - Datei	Feb 19, 2019	xml 4.2 kB	Download
-----------------------------	--------------	---------------	----------

#### Instruction Leaflet

Stecksockel mit Optokoppler Eingangsnennspannung AC/DC 115 V, Schaltstrom 0,1 A		pdf 2.4 MB	Download
--	--	---------------	----------

Elektromechanical and Solid-State Relays/Optocouplers	V 1.4.0 Oct 15, 2019	pdf 2.4 MB	Download
---	-------------------------	---------------	----------

#### Additional Information

Disposal; Electrical and electronic equipment, Packaging	V 1.0.0	pdf 265.8 kB	Download
--	---------	-----------------	----------

Step Datei Serie 857-07xx	1.0 Jun 20, 2011	ifc 299.3 kB	Download
---------------------------	---------------------	-----------------	----------

## CAD/CAE-Data

### CAD data

2D/3D Models 857-707		URL	Download
----------------------	--	-----	----------

### CAE data

EPLAN Data Portal 857-707		URL	Download
---------------------------	--	-----	----------

WSCAD Universe 857-707		URL	Download
------------------------	--	-----	----------

ZUKEN Portal 857-707		URL	Download
----------------------	--	-----	----------

## Installation Notes

Subject to changes. Please also observe the further product documentation!

WAGO Kontakttechnik GmbH & Co. KG  
Hansastr. 27  
32423 Minden  
Phone: +49571 887-0 | Fax: +49571 887-169  
Email: [info.de@wago.com](mailto:info.de@wago.com) | Web: [www.wago.com](http://www.wago.com)

Do you have any questions about our products?  
We are always happy to take your call at +49 (571) 887-44222.

### Conductor termination

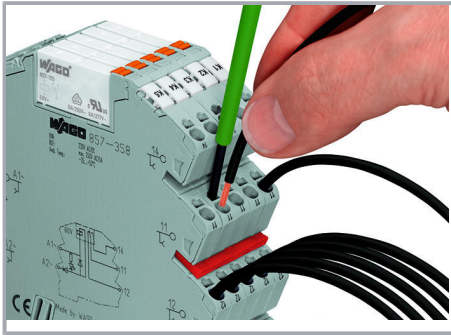

Connection of conductor

### Commoning

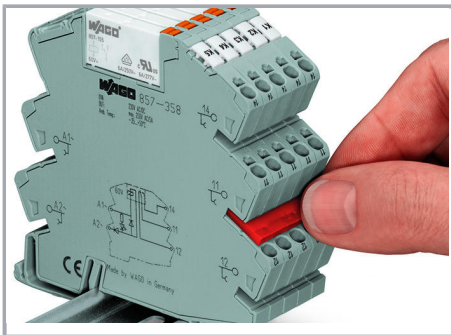

Easy commoning using adjacent jumpers

### Marking

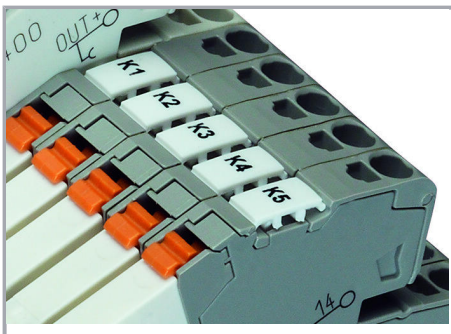

Marking using WMB Multi markers

### Installation

Subject to changes. Please also observe the further product documentation!

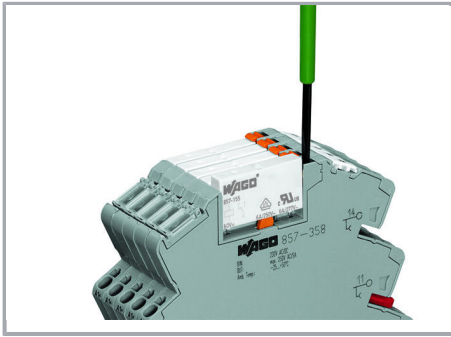

Operation of the relay ejector

Subject to changes. Please also observe the further product documentation!