

1812L Series

Surface Mount

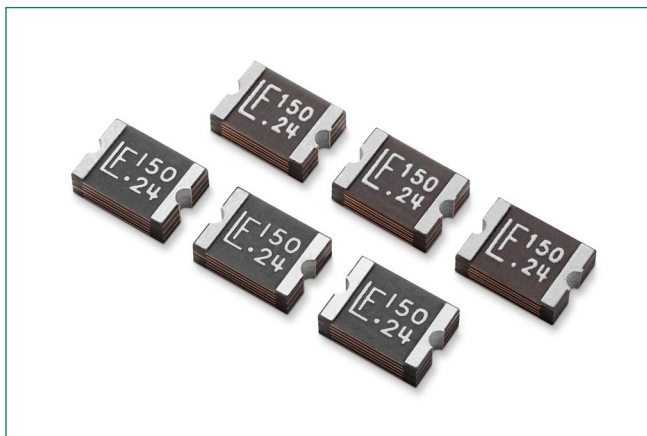

Description

The 1812L Series PTC provides surface mount overcurrent protection for applications where resettable protection is desired.

Features

- RoHS compliant, lead-free and halogen-free
- Fast response
- Compact design
- Low resistance
- Low-profile
- Compatible with high temperature solders

Applications

- Plug and play protection for motherboards and peripherals
- USB peripherals
- PCI cards
- Game console port protection

Web Resources



Download ECAD models, order samples, and find technical resources at www.littelfuse.com



Agency Approvals

Agency	Agency File Number
	E183209
	R50119118

1812L Series

Surface Mount

Electrical Characteristics

Part Number	Marking	I _{hold} (A)	I _{trip} (A)	V _{max} (Vdc)	I _{max} (A)	P _d typ. (W)	Max. Time To Trip		Resistance		Agency Approvals	
							Current (A)	Time (Sec.)	R _{min} (Ω)	R _{1max} (Ω)		
1812L010	LF010	0.10	0.30	30	100	0.8	0.50	1.50	1.600	15.000	X	X
1812L010/60	LF010●60	0.10	0.30	60	10	0.8	0.50	1.50	1.600	15.000	X	X
1812L014	LF014	0.14	0.34	60	10	0.8	1.50	0.15	1.500	6.000	X	X
1812L020	LF020	0.20	0.40	30	100	0.8	8.00	0.02	0.800	5.000	X	X
1812L020/60	LF020●60	0.20	0.40	60	40	0.8	1.00	2.00	1.400	4.400	X	X
1812L035/30	LF035●30	0.35	0.75	30	40	0.8	8.00	0.15	0.400	1.700	X	X
1812L035/60	LF035●60	0.35	0.70	60	10	1.00	8.00	0.15	0.400	1.700	X	X
1812L050 ¹	LF050	0.50	1.00	15	100	0.8	8.00	0.15	0.150	1.000	X	X
1812L050/30	LF050●30	0.50	1.00	30	100	0.8	8.00	0.15	0.150	1.000	X	X
1812L050/60	LF050●60	0.50	1.00	60	10	1.50	8.00	0.15	0.150	1.000	X	X
1812L075 ¹	LF075	0.75	1.50	13.2	100	0.8	8.00	0.20	0.100	0.450	X	X
1812L075/24 ²	LF075●24	0.75	1.50	24	100	0.8	8.00	0.20	0.110	0.290	X	X
1812L075/33	LF075●33	0.75	1.50	33	20	0.8	8.00	0.20	0.110	0.400	X	X
1812L110 ¹	LF110	1.10	2.20	8	100	0.8	8.00	0.30	0.040	0.210	X	X
1812L110/16	LF110●16	1.10	1.95	16	100	0.8	8.00	0.30	0.060	0.180	X	X
1812L110/24	LF110●24	1.10	1.95	24	20	0.8	8.00	0.50	0.060	0.200	X	X
1812L110/33	LF110●33	1.10	1.95	33	20	0.8	8.00	0.50	0.060	0.200	X	X
1812L125/6	LF125●6	1.25	2.50	6	100	0.8	8.00	0.40	0.050	0.140	X	X
1812L125/16	LF125	1.25	2.50	16	100	0.8	8.00	0.40	0.050	0.140	X	X
1812L150 ¹	LF150	1.50	3.00	8	100	0.8	8.00	0.30	0.040	0.110	X	X
1812L150/12	LF150●12	1.50	3.00	12	100	0.8	8.00	0.50	0.040	0.110	X	X
1812L150/16	LF150●16	1.50	2.80	16	100	0.8	8.00	0.50	0.040	0.110	X	X
1812L150/24 ²	LF150●24	1.50	3.00	24	20	0.8	8.00	1.50	0.040	0.120	X	X
1812L160 ¹	LF160	1.60	2.80	8	100	0.8	8.00	1.00	0.030	0.100	X	X
1812L160/12	LF160●12	1.60	2.80	12	100	0.8	8.00	1.00	0.030	0.100	X	X
1812L200TH ¹	LF200	2.00	3.50	8	100	0.8	8.00	2.00	0.020	0.070	X	X
1812L200/12	LF200●12	2.00	3.50	12	100	1.0	8.00	2.00	0.020	0.070	X	X
1812L200/16	LF200●16	2.00	3.50	16	100	1.0	8.00	2.00	0.020	0.070	X	X
1812L260TH ¹	LF260	2.60	5.20	8	100	0.8	8.00	2.50	0.015	0.047	X	X
1812L260/12	LF260●12	2.60	5.00	12	100	0.8	8.00	5.00	0.015	0.055	X	X
1812L260/16	LF260●16	2.60	5.00	16	100	1.2	8.00	5.00	0.015	0.050	X	X
1812L300	LF300	3.00	5.00	6	100	0.8	8.00	4.00	0.012	0.040	X	X

I_{hold} = Hold current; maximum current device will pass without tripping in 20°C still air.
 I_{trip} = Trip current; minimum current at which the device will trip in 20°C still air.
 V_{max} = Maximum voltage device can withstand without damage at rated current (I_{max})
 I_{max} = Maximum fault current device can withstand without damage at rated voltage (V_{max})
 P_d = Power dissipated from device when in the tripped state at 20°C still air.

R_{min} = Minimum resistance of device in initial (un-soldered) state.
 R_{typ} = Typical resistance of device in initial (un-soldered) state.
 R_{1max} = Maximum resistance of device at 20°C measured one hour after tripping or reflow soldering of 260°C for 20 sec.

Caution: Operation beyond the specified rating may result in damage and possible arcing and flame.

1 Some older references to these devices may include “-C” in the Part Number. The “-C” should be omitted when placing new orders for the device.
2 Part Number with note 2 tested and complied with AEC Q200.

1812L Series

Surface Mount

Temperature Derating

Part Number	Ambient Operation Temperature								
	-40°C	-20°C	0°C	20°C	40°C	50°C	60°C	70°C	85°C
1812L010	0.16	0.14	0.12	0.10	0.08	0.07	0.06	0.05	0.03
1812L010/60	0.16	0.14	0.12	0.10	0.08	0.07	0.06	0.05	0.03
1812L014	0.23	0.19	0.17	0.14	0.12	0.10	0.09	0.08	0.06
1812L020	0.29	0.26	0.23	0.20	0.17	0.15	0.14	0.12	0.10
1812L020/60	0.29	0.26	0.23	0.20	0.17	0.15	0.14	0.12	0.10
1812L035/30	0.50	0.45	0.40	0.35	0.30	0.26	0.24	0.20	0.16
1812L035/60	0.50	0.46	0.40	0.35	0.30	0.26	0.24	0.20	0.16
1812L050	0.77	0.68	0.59	0.50	0.44	0.40	0.37	0.33	0.29
1812L050/30	0.77	0.68	0.59	0.50	0.44	0.40	0.37	0.33	0.29
1812L050/60	0.77	0.68	0.59	0.50	0.44	0.40	0.37	0.33	0.29
1812L075	1.15	1.01	0.88	0.75	0.65	0.60	0.55	0.49	0.43
1812L075/24	1.06	0.95	0.84	0.75	0.60	0.55	0.50	0.45	0.37
1812L075/33	1.10	1.00	0.88	0.75	0.66	0.60	0.56	0.47	0.36
1812L110	1.59	1.43	1.26	1.10	0.95	0.87	0.80	0.71	0.60
1812L110/16	1.58	1.43	1.27	1.10	0.95	0.85	0.77	0.71	0.58
1812L110/24	1.55	1.40	1.25	1.10	0.93	0.83	0.73	0.63	0.50
1812L110/33	1.55	1.40	1.25	1.10	0.93	0.83	0.73	0.63	0.50
1812L125/6	2.00	1.75	1.52	1.25	1.00	0.95	0.90	0.75	0.53
1812L125/16	2.00	1.75	1.52	1.25	1.00	0.95	0.90	0.75	0.53
1812L150	2.06	1.93	1.79	1.50	1.28	1.10	1.02	0.80	0.68
1812L150/12	2.04	1.88	1.68	1.50	1.25	1.10	1.00	0.80	0.60
1812L150/16	2.04	1.88	1.68	1.50	1.25	1.10	1.00	0.80	0.60
1812L150/24	2.05	1.87	1.67	1.50	1.25	1.08	0.95	0.77	0.60
1812L160	2.20	2.06	1.91	1.60	1.36	1.17	1.09	0.85	0.72
1812L160/12	2.20	2.06	1.91	1.60	1.36	1.17	1.09	0.85	0.72
1812L200TH	2.60	2.44	2.22	2.00	1.78	1.67	1.50	1.45	1.29
1812L200/12	2.60	2.44	2.22	2.00	1.78	1.67	1.50	1.45	1.29
1812L200/16	2.60	2.44	2.22	2.00	1.78	1.67	1.50	1.45	1.29
1812L260TH	3.40	3.16	3.00	2.60	2.30	2.15	2.00	1.85	1.63
1812L260/12	3.40	3.16	3.00	2.60	2.30	2.15	2.00	1.85	1.63
1812L260/16	3.40	3.16	3.30	2.60	2.30	2.15	2.00	1.85	1.63
1812L300	4.13	3.75	3.30	3.00	2.62	2.43	2.25	2.00	1.78

Notes: The temperature derating data is only for reference, please contact Littelfuse technical support for detail temperature derating information.

1812L Series

Surface Mount

Temperature Derating Curve

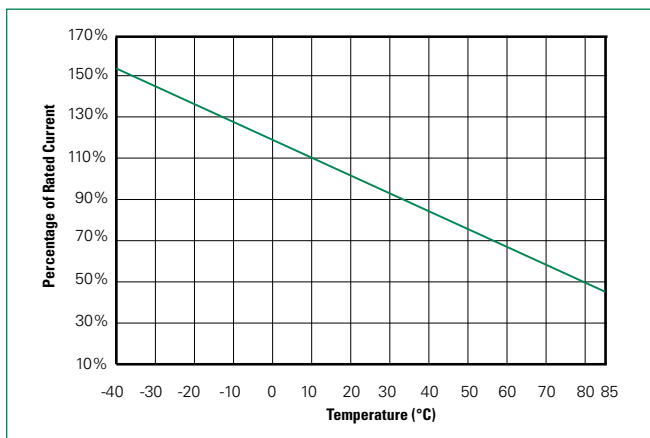

Note: Typical Temperature derating curve, refer to table for derating data

Physical Specifications

Terminal Material	Solder-Plated Copper (Solder Material: Matte Tin (Sn))
Lead Solderability	Meets EIA Specification RS186-9E, ANSI/J-STD-002 Category 3.

Environmental Specifications

Operating Temp.	-40°C to +85°C
Max. Device Surface Temp. in Tripped State	125°C
Passive Aging	+85°C, 1000 hours -/+5% typical resistance change
Humidity Aging	+85°C, 85% R.H., 1000 hours -/+5% typical resistance change
Thermal Shock	MIL-STD-202, Method 107 +85°C/-40°C 20 times -30% typical resistance change
Solvent Resistance	MIL-STD-202, Method 215, No change
Vibration	MIL-STD-883, Method 2007, Condition A, No change
Moisture Level Sensitivity	Level 1, J-STD-020

Soldering Parameters

Profile Feature	Pb-Free Assembly	
Average Ramp-Up Rate ($T_{S(max)}$ to T_p)	3°C/second max	
Pre Heat:	Temperature Min ($T_{s(min)}$)	150°C
	Temperature Max ($T_{s(max)}$)	200°C
	Time (Min to Max) (t_s)	60 – 180 secs
Time Maintained Above:	Temperature (T_L)	217°C
	Temperature (t_L)	60 – 150 seconds
Peak / Classification Temperature (T_p)	260 ^{+0/-5} °C	
Time within 5°C of actual peak Temperature (t_p)	20 – 40 seconds	
Ramp-down Rate	6°C/second max	
Time 25°C to peak Temperature (T_p)	8 minutes Max.	

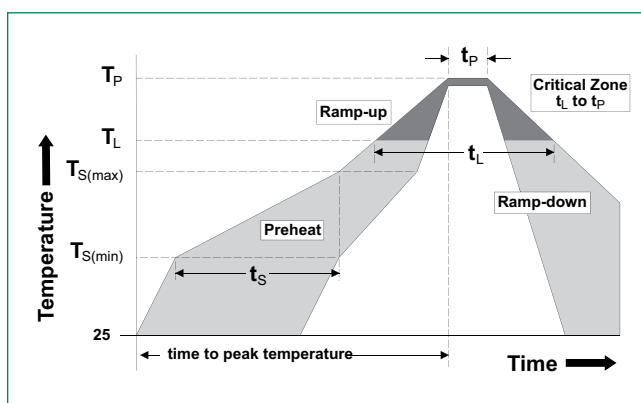

1812L Series

Surface Mount

Average Time Current Curves

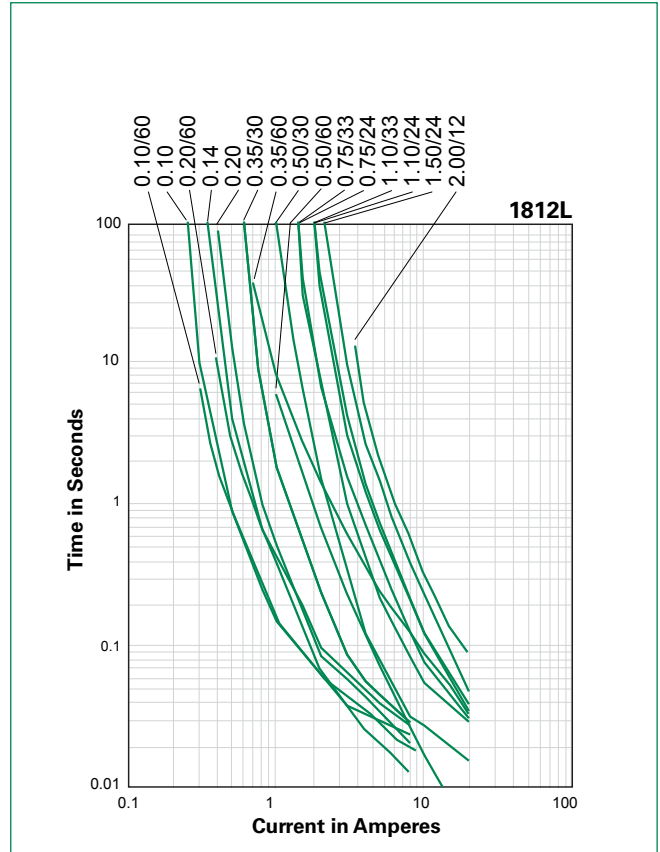
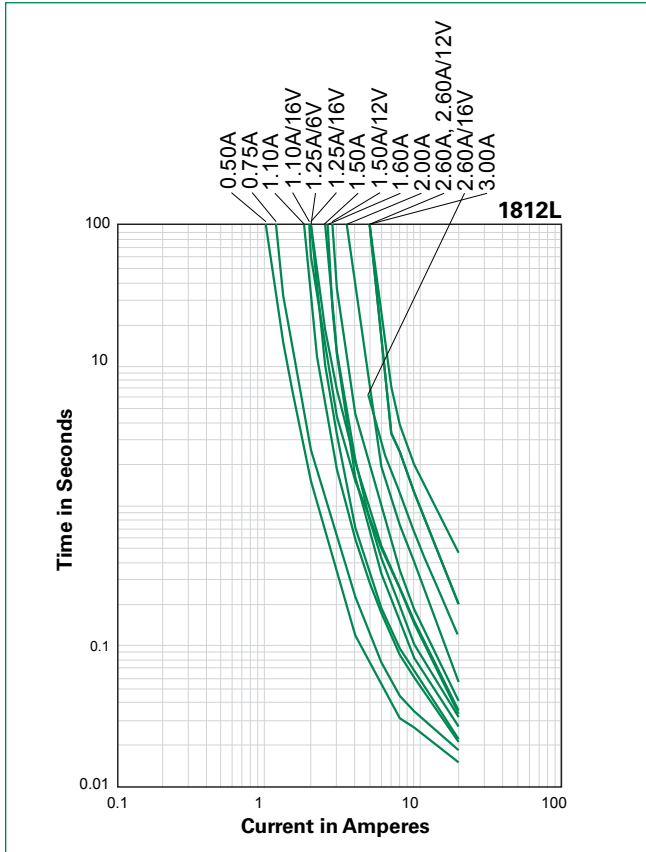

The average time current curves and Temperature Derating curve performance is affected by a number of variables, and these curves provided as guidance only. Customer must verify the performance in their application.

1812L Series

Surface Mount

Dimensions

MARKING CODE VARIES
WITH AMPERAGE AND VOLTAGE RATING
(See Electrical Characteristics Table)
SHOWN ARE:
- 1.1A/6V RATING (LEFT)
- 1.1A/33V RATING (RIGHT)

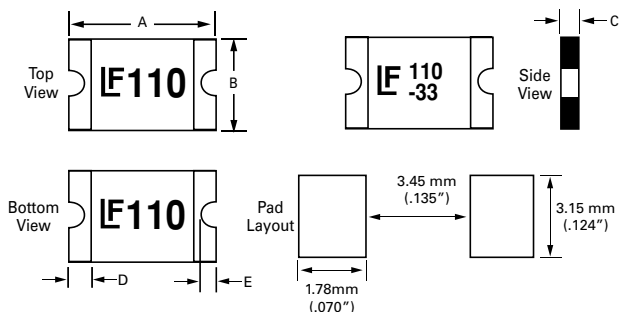

Part Number	A		B		C		D		E											
	Inches		mm		Inches		mm		Inches		mm		Inches		mm		Inches		mm	
	Min	Max	Min	Max	Min	Max	Min	Max	Min	Max	Min	Max	Min	Max	Min	Max	Min	Max	Min	Max
1812L010	0.17	0.19	4.37	4.73	0.12	0.13	3.07	3.41	0.03	0.05	0.75	1.25	0.01	0.05	0.3	1.2	0.01	0.03	0.15	0.65
1812L010/60	0.17	0.19	4.37	4.73	0.12	0.13	3.07	3.41	0.03	0.05	0.75	1.25	0.01	0.05	0.3	1.2	0.01	0.03	0.15	0.65
1812L014	0.17	0.19	4.37	4.73	0.12	0.13	3.07	3.41	0.03	0.08	0.75	1.95	0.01	0.05	0.3	1.2	0.01	0.03	0.15	0.65
1812L020	0.17	0.19	4.37	4.73	0.12	0.13	3.07	3.41	0.02	0.04	0.55	1.00	0.01	0.05	0.3	1.2	0.01	0.03	0.15	0.65
1812L020/60	0.17	0.19	4.37	4.73	0.12	0.13	3.07	3.41	0.03	0.05	0.75	1.25	0.01	0.05	0.3	1.20	0.01	0.03	0.15	0.65
1812L035/30	0.17	0.19	4.37	4.73	0.12	0.13	3.07	3.41	0.02	0.04	0.6	1.25	0.01	0.05	0.3	1.20	0.01	0.03	0.15	0.65
1812L035/60	0.17	0.19	4.37	4.73	0.12	0.13	3.07	3.41	0.05	0.07	1.2	1.8	0.01	0.05	0.3	1.2	0.01	0.03	0.15	0.65
1812L050	0.17	0.19	4.37	4.73	0.12	0.13	3.07	3.41	0.02	0.03	0.5	0.75	0.01	0.05	0.3	1.2	0.01	0.02	0.15	0.50
1812L050/30	0.17	0.19	4.37	4.73	0.12	0.13	3.07	3.41	0.02	0.04	0.5	1.00	0.01	0.05	0.3	1.2	0.01	0.03	0.15	0.65
1812L050/60	0.17	0.19	4.37	4.73	0.12	0.13	3.07	3.41	0.05	0.07	1.2	1.8	0.01	0.05	0.3	1.2	0.01	0.03	0.15	0.65
1812L075	0.17	0.19	4.37	4.73	0.12	0.13	3.07	3.41	0.02	0.03	0.5	0.75	0.01	0.05	0.3	1.2	0.01	0.02	0.15	0.50
1812L075/24	0.17	0.19	4.37	4.73	0.12	0.13	3.07	3.41	0.03	0.05	0.75	1.20	0.01	0.05	0.3	1.2	0.01	0.03	0.15	0.65
1812L075/33	0.17	0.19	4.37	4.73	0.12	0.13	3.07	3.41	0.03	0.06	0.75	1.55	0.01	0.05	0.3	1.2	0.01	0.03	0.15	0.65
1812L110	0.17	0.19	4.37	4.73	0.12	0.13	3.07	3.41	0.02	0.03	0.50	0.71	0.01	0.05	0.3	1.2	0.01	0.02	0.15	0.65
1812L110/24	0.17	0.19	4.37	4.73	0.12	0.13	3.07	3.41	0.02	0.04	0.50	1.07	0.01	0.05	0.3	1.2	0.01	0.03	0.15	0.65
1812L110/16	0.17	0.19	4.37	4.73	0.12	0.13	3.07	3.41	0.03	0.05	0.75	1.25	0.01	0.05	0.3	1.2	0.01	0.03	0.15	0.65
1812L110/33	0.17	0.19	4.37	4.73	0.12	0.13	3.07	3.41	0.05	0.08	1.20	2.00	0.01	0.05	0.3	1.2	0.01	0.03	0.15	0.65
1812L125/6	0.17	0.19	4.37	4.73	0.12	0.13	3.07	3.41	0.02	0.03	0.45	0.75	0.01	0.05	0.3	1.2	0.01	0.03	0.15	0.65
1812L125/16	0.17	0.19	4.37	4.73	0.12	0.13	3.07	3.41	0.03	0.05	0.75	1.25	0.01	0.05	0.3	1.2	0.01	0.02	0.15	0.65
1812L150	0.17	0.19	4.37	4.73	0.12	0.13	3.07	3.41	0.02	0.03	0.30	0.71	0.01	0.05	0.3	1.2	0.01	0.03	0.15	0.65
1812L150/12	0.17	0.19	4.37	4.73	0.12	0.13	3.07	3.41	0.03	0.05	0.75	1.25	0.01	0.05	0.3	1.2	0.01	0.03	0.15	0.65
1812L150/16	0.17	0.19	4.37	4.73	0.12	0.13	3.07	3.41	0.03	0.05	0.75	1.25	0.01	0.05	0.3	1.2	0.01	0.03	0.15	0.65
1812L150/24	0.17	0.19	4.37	4.73	0.12	0.13	3.07	3.41	0.03	0.07	0.80	1.8	0.01	0.05	0.3	1.2	0.01	0.03	0.15	0.65
1812L160	0.17	0.19	4.37	4.73	0.12	0.13	3.07	3.41	0.02	0.03	0.40	0.75	0.01	0.05	0.3	1.2	0.01	0.03	0.15	0.65
1812L160/12	0.17	0.19	4.37	4.73	0.12	0.13	3.07	3.41	0.03	0.05	0.75	1.25	0.01	0.05	0.3	1.2	1.2	0.01	0.15	0.65
1812L200TH	0.17	0.19	4.37	4.73	0.12	0.13	3.07	3.41	0.008	0.024	0.20	0.6	0.01	0.05	0.3	1.2	0.01	0.02	0.15	0.65
1812L200/12	0.17	0.19	4.37	4.73	0.12	0.13	3.07	3.41	0.03	0.05	0.80	1.20	0.012	0.047	0.3	1.2	0.01	0.026	0.15	0.65
1812L200/16	0.17	0.19	4.37	4.73	0.12	0.13	3.07	3.41	0.03	0.05	0.80	1.20	0.012	0.047	0.3	1.2	0.01	0.026	0.15	0.65
1812L260TH	0.17	0.19	4.37	4.73	0.12	0.13	3.07	3.41	0.02	0.04	0.50	1.00	0.01	0.05	0.3	1.2	0.01	0.02	0.15	0.65
1812L260/12	0.17	0.19	4.37	4.73	0.12	0.13	3.07	3.41	0.03	0.05	0.80	1.34	0.01	0.05	0.3	1.2	0.01	0.03	0.15	0.65
1812L260/16	0.18	0.19	4.54	4.90	0.12	0.14	3.16	3.50	0.05	0.08	1.20	2.00	0.012	0.047	0.3	1.2	0.006	0.03	0.15	0.65
1812L300	0.17	0.19	4.37	4.73	0.12	0.13	3.07	3.41	0.02	0.06	0.50	1.50	0.01	0.05	0.3	1.2	0.01	0.03	0.15	0.65

1812L Series

Surface Mount

Part Ordering Number System

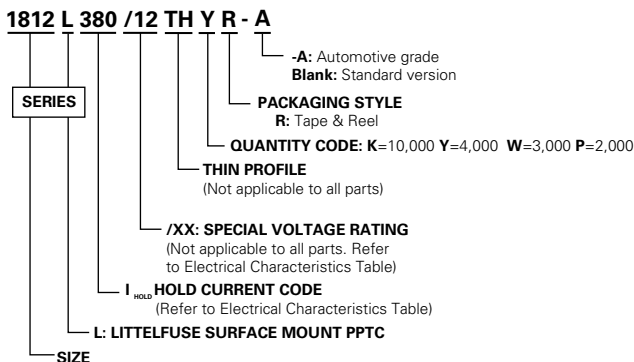

Packaging

Part Number	Ordering Number	Halogen Free	I _{hold} (A)	I _{hold} Code	Voltage Option	Packaging Option	Quantity	Quantity & Packaging Code
1812L010	1812L010DR	Yes	0.10	010	-	Tape and Reel	1500	DR
1812L010/60	1812L010/60DR	Yes	0.10	010	/60		1500	DR
1812L014	1812L014DR	Yes	0.14	014	-		1500	DR
1812L020	1812L020PR	Yes	0.20	020	-		2000	PR
1812L020/60	1812L020/60DR	Yes	0.20	020	/60		1500	DR
1812L035/30	1812L035/30DR	Yes	0.35	035	/30		1500	DR
1812L035/60	1812L035/60MR	Yes	0.35	035	/60		1000	MR
1812L050	1812L050PR	Yes	0.50	050	-		2000	PR
1812L050/30	1812L050/30PR	Yes	0.50	050	/30		2000	PR
1812L050/60	1812L050/60MR	Yes	0.50	050	/60		1000	MR
1812L075	1812L075PR	Yes	0.75	075	-		2000	PR
1812L075/24	1812L075/24DR	Yes	0.75	075	/24		1500	DR
1812L075/33	1812L075/33DR	Yes	0.75	075	/33		1500	DR
1812L110	1812L110PR	Yes	1.10	110	-		2000	PR
1812L110/16	1812L110/16DR	Yes	1.10	110	/16		1500	DR
1812L110/24	1812L110/24DR	Yes	1.10	110	/24		1500	DR
1812L110/33	1812L110/33MR	Yes	1.10	110	/33		1000	MR
1812L125/6	1812L125/6PR	Yes	1.25	125	/6		2000	PR
1812L125/16	1812L125/16DR	Yes	1.25	125	/16		1500	DR
1812L150	1812L150ZR	Yes	1.50	150	-		2000	ZR
1812L150/12	1812L150/12DR	Yes	1.50	150	/12		1500	DR
1812L150/16	1812L150/16DR	Yes	1.50	150	/16		1500	DR
1812L150/24	1812L150/24MR	Yes	1.50	150	/24		1000	MR
1812L160	1812L160PR	Yes	1.60	160	-		2000	PR
1812L160/12	1812L160/12DR	Yes	1.60	160	/12		1500	DR
1812L200TH	1812L200THPR	Yes	2.00	200	-		2000	PR
1812L200/12	1812L200/12DR	Yes	2.00	200	/12		1500	DR
1812L200/16	1812L200/16DR	Yes	2.00	200	/16		1500	DR
1812L260TH	1812L260THDR	Yes	2.60	260	-		1500	DR
1812L260/12	1812L260/12MR	Yes	2.60	260	/12		1000	MR
1812L260/16	1812L260/16MR	Yes	2.60	260	/16		1000	MR
1812L300	1812L300MR	Yes	3.00	300	-		1000	MR

1812L Series

Surface Mount

Tape and Reel Specifications

TAPE SPECIFICATIONS: EIA-481-1 (mm)			
	1812L020 1812L050/30 1812L050 1812L075 1812L110 1812L125/6 1812L150 1812L160 1812L200	1812L010 1812L010/60 1812L014 1812L020/60 1812L035/30 1812L075/24 1812L075/33 1812L110/16 1812L110/24 1812L125/16 1812L150/12 1812L150/16 1812L160/12 1812L200/16 1812L260	1812L035/60 1812L050/60 1812L110/33 1812L150/24 1812L260/12 1812L260/16 1812L300
W	12.00 ± 0.30	12.00 ± 0.30	12.00 ± 0.30
F	5.50 ± 0.05	5.50 ± 0.05	5.50 ± 0.05
E₁	1.75 ± 0.10	1.75 ± 0.10	1.75 ± 0.10
D₀	1.55 ± 0.10	1.55±/0.05	1.55 ± 0.05
D₁	1.55 (min)	1.50±/0.10	1.50 (MIN)
P₀	4.00 ± 0.10	4.00 ± 0.10	4.00 ± 0.08
P₁	8.00 ± 0.10	8.00 ± 0.10	8.00 ± 0.10
P₂	2.00 ± 0.05	2.00 ± 0.05	2.00 ± 0.05
A₀	3.58 ± 0.10	3.50 ± 0.10	3.58 ± 0.10
B₀	4.93 ± 0.10	4.85± 0.10	4.93 ± 0.10
T	0.25 ± 0.10	0.25 ± 0.10	0.25 ± 0.10
K₀	0.87± 0.06	1.25 ± 0.10	2.10 ± 0.10
Leader min.	390	390	390
Trailer min.	160	160	160

REEL DIMENSIONS: EIA-481-1 (mm)	
C	Ø178 ± 1.0
D	Ø60.2 ± 0.5
H	16.0 ± 0.5
W	13.2 ± 1.5

Tape and Reel Diagram

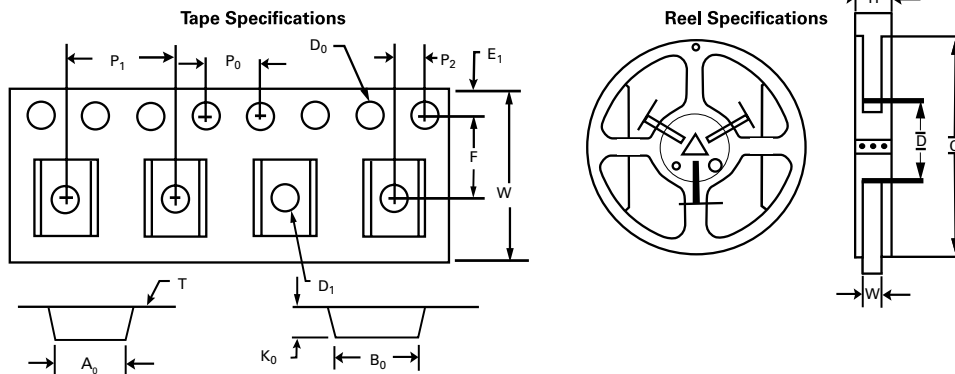

Warning

- Users should independently evaluate the suitability of and test each product selected for their own application.
- Operation beyond the maximum ratings or improper use may result in device damage and possible electrical arcing and flame.
- These devices are intended for protection against damage caused by occasional overcurrent or overtemperature fault conditions and should not be used when repeated fault conditions or prolonged trip events are anticipated.
- Contamination of the PPTC material with certain silicone-based oils or some aggressive solvents can adversely impact the performance of the devices.
- Device performance can be impacted negatively if devices are handled in a manner inconsistent with recommended electronic, thermal, and mechanical procedures for electronic components.
- PPTC devices are not recommended for installation in applications where the device is constrained such that its PTC properties are inhibited, for example in rigid potting materials or in rigid housings, which lack adequate clearance to accommodate device expansion.
- Operation in circuits with a large inductance can generate a circuit voltage (Ldi/dt) above the rated voltage of the device.

Disclaimer Notice - Information furnished is believed to be accurate and reliable. However, users should independently evaluate the suitability of and test each product selected for their own applications. Littelfuse products are not designed for, and may not be used in, all applications. Read complete Disclaimer Notice at www.littelfuse.com/disclaimer-electronics.