



PLD-1315 and PLD-231X Series

Longwavelength Singlemode FiberOptic TX & RX Modules



Product Data Sheet

DESCRIPTION

The PLD-1315 and PLD-231X Series are designed to be backward compatible with industry standard sources and detectors used for single mode fiber applications. This form factor allows designers to offer single mode fiber performance in applications which currently use short wavelength (850 nm) devices in identical form factor packages . A link upgrade from multimode to single mode fiber can be done as easily as swapping out the optical components on the printed circuit board.

TRANSMITTER

The PDL-1315M/TM is constructed using a 1300 nm Edge Emitting LED (ELED) . Such ELED's efficiently couple their optical output into single mode optical fiber. Although a single mode emitter, driving the ELED can be done with the same circuitry used with multimode LED based components. Such circuitry is much simpler than that used with LASER based emitters given that no optical feedback is required with an ELED.

RECEIVER

Two semiconductors make up the heart of the HFBR-231XM/TM receiver modules: a 75 um diameter InGaAs PIN photodiode and a silicon based trans-impedance amplifier (TIA). The PIN photodiode is optimized for high response in the 1300 nm wavelength region and has been teamed with a low noise TIA . The optical signals are detected by the PIN and converted to an analog voltage output with a very low input noise current contribution. The TIA is available with or without an Automatic Gain Control (AGC) circuit that decreases the light to voltage conversion factor when the average incident optical power is relatively high. There are three (3) versions of receivers available;

- PLD-2315M/TM: with AGC
- PLD-2316M/TM: no AGC and with same pin-out as the PLD-2315
- PLD-2317M/TM: no AGC and pin-out compatible with pcb's designed for Agilent HFBR-2315 series

All of the receivers have differential output signals, but may also be operated in a single ended fashion by tying the negative output pin to ground.

The receiver offers a sensitivity of better than -36 dBm at 100 MHz and with appropriate filtering a minimum overload value of 0 dBm. This large dynamic range make it ideal for both long and short range applications.

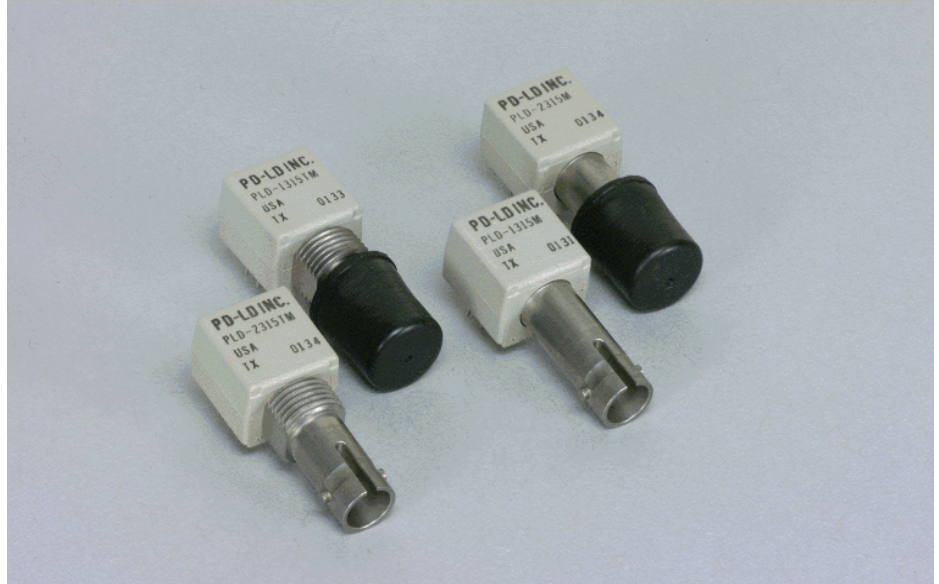

FEATURES, RX

- InGaAs photodiode w/ integrated TIA , 1310nm operation
- Up to 150 Mb/s differential signal output
- Automatic Gain Control (AGC) available
- Single ended or differential output

FEATURES, TX

- InGaAsP 1310nm Edge Emitting LED
- Singlemode 9/125 μm fiber coupled
- ST Connector Interface
- Wave Solder and Aqueous Wash Compatible

APPLICATIONS

- Single mode Extensions to Ethernet (10 Base-F) Links
- Unique Single-Mode Fiber Links

Package Options

	Threaded Metal Port	Unthreaded Metal Port
Transmitter (TX)	PLD-1315TM	PLD-1315M
Receiver (RX)	PLD-231XTM	PLD-231XM

PACKAGE

These transmitters and receivers offered by PD-LD are built with stainless steel ST style ports in threaded or unthreaded versions. The threaded versions, designated TM, may be used for panel mounting of the components. The package housings are made of heat resistant, chemical resistant, high strength and UL V-O flame retardant plastic. The 2X4 dual in line lead configuration offers superior mechanical retention to the circuit board after soldering

PROCESS COMPATABILITY

The PLD-1315 and PLD-2315 series of components are intended use with industry standard board cleaning processes. When the devices are fitted with their protective process cap the units may be subjected to the following cleaning and degreasing processes:

- Water Wash (Aqueous)
- Alcohol (isopropyl, isobutyl and methyl)
- Aliphatics (heptane and hexane)
- Naptha

The units cannot be exposed to the following chemicals which will damage the plastic package: Partially halogenated hydrocarbons such as 1,1,1 Trichloroethane, Ketones such as MEK, Acetone, Chloroform, Ethyl Acetate, Methylene Dichloride and N-methylpyrrolidone.

SOLDERING ATTACHMENT

The PDL-1315 and PLD-231X series products may be soldered to printed circuit boards by either hand or wave solder methodologies. As specified, the devices should be subjected to no greater than 260°C ,at 2mm from where the leads enter the devices case, for 10 seconds during wave soldering. During any processing it is critical to leave the protective process cap on the units in order to protect the optical pathway from obstruction by debris or particulates. Such obstructions will impair the products performance. To clean away such obstructions it is usually sufficient to use clean compressed air. If necessary, a second cleaning step can be to use methanol on a cotton swab to remove any dirt.

STATIC HANDLING PRECAUTIONS

Normal static precautions should be taken in handling and during assembly of these components to prevent damage that may be caused by electrostatic discharge, ESD.

FLAME RESISTANCE

The PLD-1315 and PLD-231X series devices are constructed with plastic housings that meet UL 94 V-0 flame retardant criteria.

ELECTROSTATIC DISCHARGE (ESD)

During system qualification it is normal to subject the equipment chassis to ESD testing . The PDL-1315 and PLD-231X series devices may be subjected to such testing as it is expected that the components metal ST ports will be exposed to similar discharges. To the degree that the system chassis will be exposed to ESD, the component connectors may be exposed to the same extent.

RADIATED SUSCEPTIBILITY

It is normal to expect that systems or equipment in which the PLD-1315 and PLD-231X components are used will be exposed to or tested for electro magnetic interference (EMI). These devices have been designed so that they may be operated within such fields with no measurable degradation in their performance. This statement has been made under the assumption that the devices are mounted to a printed circuit board that is tested in free space and not within a system chassis. No claim can be made, however, as to systems level EMI susceptibility or emissions when the entire system chassis is considered.

PANEL MOUNTING OF THREADED ST PACKAGE STYLE

The PLD-1315TM and PLD-231XTM style packages are equipped with mounting threads for panel mounting. These units may be mounted to a panel so long as the overall thickness of the chassis wall, washer and nut are less than 5.1 mm (0.2 inches). The devices may be attached using any standard 3/32 UNEF-2B threaded nut and washer. The outer diameter of the nuts should be approximately 12.70 mm (0.50 inches) with the washer being slightly larger, 14.27 mm (0.563 inches). Note that the maximum nut dimensions exceeds the width of the port package, so approximately 2 mm of space should be left between device packages so that nuts can be mounted on adjacent ports.

When preparing the chassis wall for panel mounting, use the template below for the proper cut out dimensions.

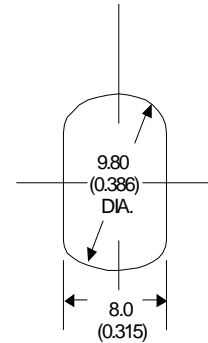

NOTE: ALL DIMENSIONS IN MILLIMETERS AND (INCHES).

When tightening the nut, torque should not exceed 0.8 N-m (8.0 in-lb).

RoHS Compliance

These products are in compliance with EU directives on the Restriction on the use of certain Hazardous Substances (RoHS) and Waste from Electrical and Electronic Equipment (WEEE). These products are deemed RoHS free of lead, cadmium, mercury, hexavalent chromium, PBB or PBDE content in their components and product.

PINOUT DESCRIPTION

PLD-1315TM & PLD-1315M TRANSMITTERS

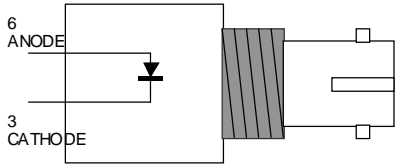

PLD-2315TM & PLD-2315M RECEIVERS

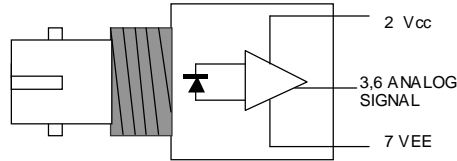

MECHANICAL DIMENSIONS ALL DIMENSIONS IN MILLIMETERS AND (INCHES)

PINS 1,4,5,8
0.51 X 0.38
(0.020 X 0.015)

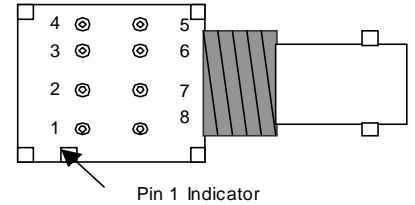

PINS 2,3,6,7
0.45 DIA.
(0.018)

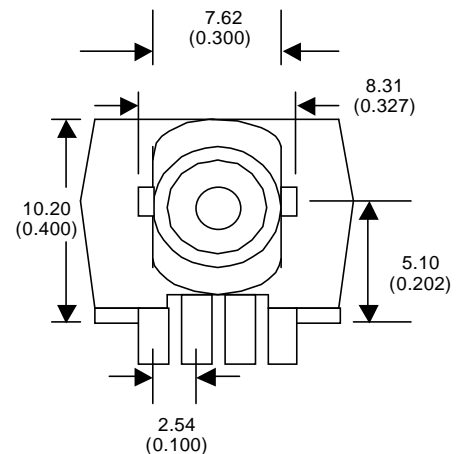
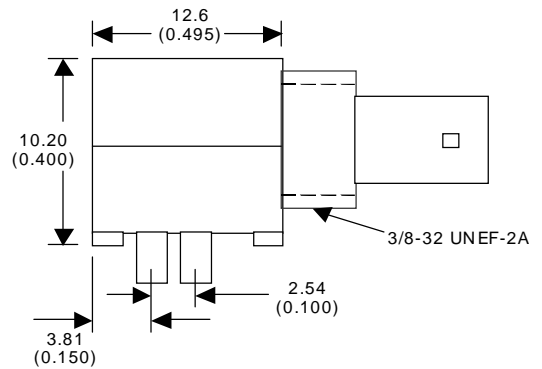
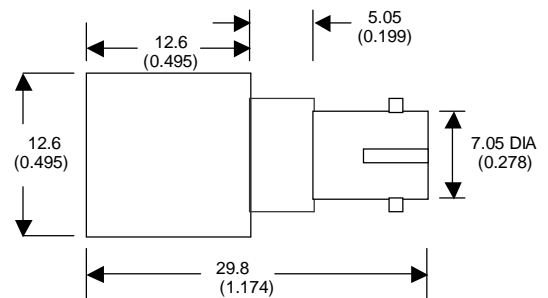
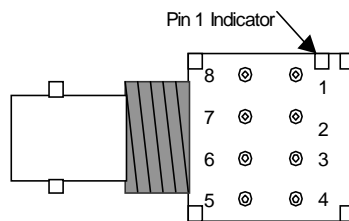
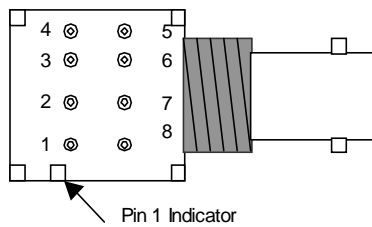

Note that drawings are not to scale.

PIN	FUNCTION
1*	N.C.
2°	N.C.
3	CATHODE
4*	N.C.
5*	N.C.
6	ANODE
7	N.C.
8*	N.C.

PIN	FUNCTION
1*	N.C.
2	5V
3	SIGNAL-
4*	N.C.
5*	N.C.
6	SIGNAL+
7†	GROUND
8*	N.C.

° IN THE NUMBER 2 PIN POSITION THERE IS PHYSICALLY NO PIN.

* PINS 1,4,5 AND 8 ARE ISOLATED FROM THE INTERNAL CIRCUITRY , BUT ARE ELECTRICALLY CONNECTED TO EACH OTHER AND TO THE METAL PORT.

† PIN 7 IS ELECTRICALLY CONNECTED TO THE HEADER.

* PINS 1,4,5 AND 8 ARE ISOLATED FROM THE INTERNAL CIRCUITRY , BUT ARE ELECTRICALLY CONNECTED TO EACH OTHER AND TO THE METAL PORT.

PLD-2316TM & PLD-2316M RECEIVERS

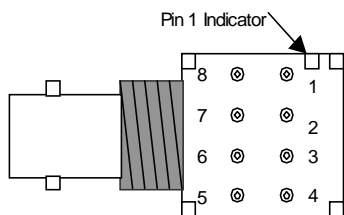
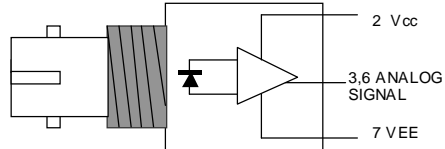

PIN	FUNCTION
1*	N.C.
2	5V
3	SIGNAL-
4*	N.C.
5*	N.C.
6	SIGNAL+
7†	GROUND
8*	N.C.

† PIN 7 IS ELECTRICALLY CONNECTED TO THE HEADER.

* PINS 1,4,5 AND 8 ARE ISOLATED FROM THE INTERNAL CIRCUITRY , BUT ARE ELECTRICALLY CONNECTED TO EACH OTHER AND TO THE METAL PORT.

PLD-2317TM & PLD-2317M RECEIVERS

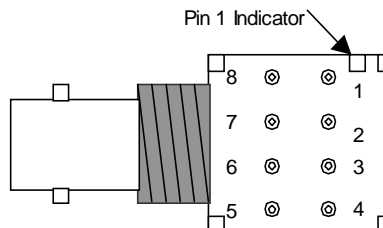
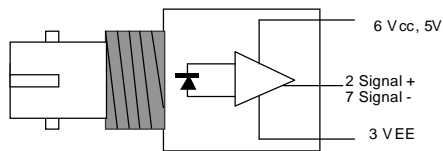

PIN	FUNCTION
1*	N.C.
2	Signal +
3†	Vee, Ground
4*	N.C.
5*	N.C.
6	Vcc, 5V
7‡	Signal -
8*	N.C.

† PIN 3 IS ELECTRICALLY CONNECTED TO THE HEADER.

‡ PIN 7 may be tied to ground to achieve functionality similar to HFBR-2315 .

* PINS 1,4,5 AND 8 ARE ISOLATED FROM THE INTERNAL CIRCUITRY , BUT ARE ELECTRICALLY CONNECTED TO EACH OTHER AND TO THE METAL PORT.

ABSOLUTE MAXIMUM RATINGS FOR PLD-1315 AND PLD2315 SERIES COMPONENTS

PARAMETER	SYMBOL	MIN	MAX	UNIT	NOTE
STORAGE TEMPERATURE	T_S	-40	85	°C	
OPERATING TEMPERATURE	T_A	-40	85	°C	
LEAD SOLDERING CYCLE TEMPERATURE			260	°C	2mm from where lead enters case
LEAD SOLDERING CYCLE TIME			10	sec	
FORWARD INPUT CURRENT dc (TX only)	I_{FDC}		100	mA	
FORWARD INPUT CURRENT, PEAK (TX only)	I_{FPK}		175	mA	1 sec pulse
REVERSE INPUT VOLTAGE (TX only)	V_R		1	V	
SIGNAL PIN VOLTAGE (RX only)	V_O	-0.5	V_{CC}	V	With filtered power supply
SUPPLY VOLTAGE (RX only)	$(V_{CC}-V_{EE})$	-0.5	6.0	V	
OUTPUT CURRENT (RX only)	I_O		25	mA	

RECOMMENDED OPERATING CONDITIONS FOR PLD-1315 AND PLD-231X SERIES COMPONENTS

PARAMETER	SYMBOL	MIN	TYP	MAX	UNIT
OPERATING TEMPERATURE-AMBIENT	T_A	0		70	°C
SUPPLY VOLTAGE	V_{CC}	4.75		5.25	V

PLD-1315TM & PLD-1315M TRANSMITTER CHARACTERISTICS W/ 9/125um FIBER @100mA

PARAMETER	SYMBOL	MIN	TYP	MAX	UNIT	CONDITION
PEAK POWER SINGLE-MODE	P_T	-23	-20	-15	dBm	25°C, 100 mA
		-29		-12		0 to 70°C, 100 mA
		-27		-10		-20 to 55°C, 100 mA
OPTICAL WAVELENGTH TEMPERATURE COEFFICIENT	Delta Lambda/ DeltaT		0.83		nm/°C	
CENTER WAVELENGTH	λ_{c}	1270		1330	nm	25°C
SPECTRAL WIDTH	Delta Lambda	40	45	100	nm	25°C
CUT OFF FREQUENCY	f_c		150		MHz	25°C
THERMAL RESISTANCE	θ_{JA}		105		°C/W	

PLD-2315TM & PLD-2315M RECEIVER ELECTRICAL/OPTICAL CHARACTERISTICS W/ 9/125um FIBER, $\lambda=1310$ nm

PARAMETER	SYMBOL	MIN	TYP	MAX	UNIT	CONDITION
GAIN, DIFFERENTIAL	G	0.17		0.22	V/mW	@10Mb/s
GAIN, SINGLE ENDED	G	0.09		0.11	V/mW	@10Mb/s
BANDWIDTH	BW	120	140		MHz	At -3dB point
SENSITIVITY	Sens		-38	-35	dBm	BER= 10^{-10} @155Mbps
PEAK INPUT POWER w/AGC	P_R		0	-3	dBm	50MHz
OUTPUT RESISTANCE	Z_O		50	65	Ohm	50MHz
SUPPLY CURRENT	I_{CC}			35	mA	NO LOAD
OUTPUT OFFSET VOLTAGE	V_{OS}	$V_{CC}-3.5$	$V_{CC}-2.5$	$V_{CC}-1.5$	V	

PLD-2316M/TM & PLD-2317M/TM RECEIVER ELECTRICAL/OPTICAL CHARACTERISTICS W/ 9/125um FIBER,

PARAMETER	SYMBOL	MIN	TYP	MAX	UNIT	CONDITION
Differential Gain (no AGC)	G	10	20	45	V/mw	@10Mb/s
BANDWIDTH	BW	90	130		MHz	At -3dB point
SENSITIVITY	Sens		-38	-36	dBm	BER=10 ⁻¹⁰ @155Mbps
PEAK INPUT POWER (no AGC)	P _R	-	-	-17	dBm	50MHz
OUTPUT RESISTANCE	Z _O	36	44	57	Ohm	50MHz
SUPPLY CURRENT	I _{CC}	20	38	60	mA	(RL=50 ohm)
DIFFERENTIAL OUTPUT OFFSET VOLTAGE	V _{OO}	-50	55	150	mV	

Recommended Transmitter Drive and Test Circuit

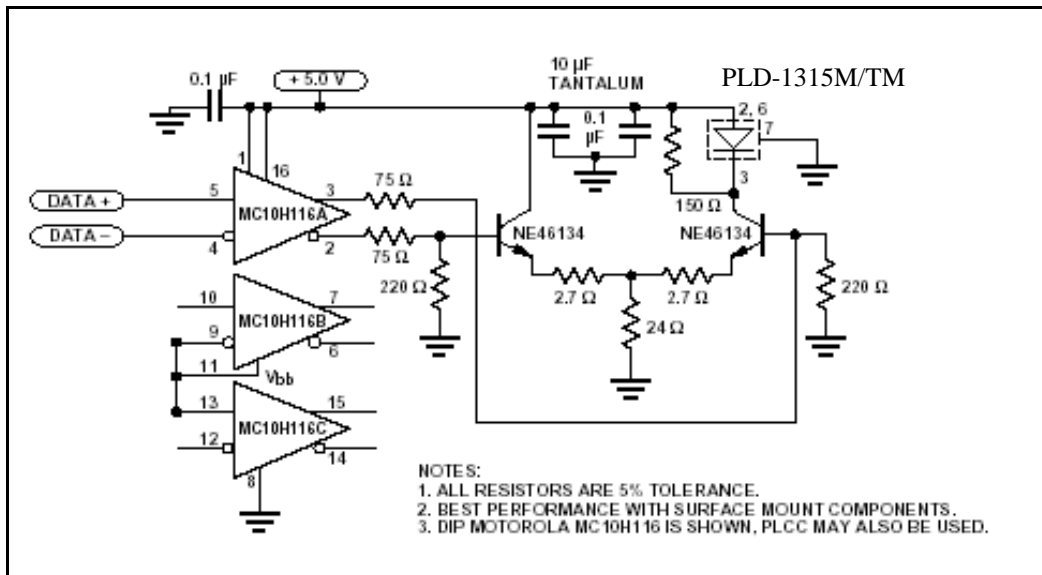

Recommended Test Circuit for PLD-2317M/TM

