

Typical Common Electrical Characteristics<sup>1</sup>

Inductance	350uH Min.	0.1Vrms, 100kHz, 8mADC
Dielectric Rating	1500VAC	for 1 minute
Insertion Loss	-1.1dB max.	300kHz-100MHz
Return Loss	-18dB min.	500kHz-30MHz
	-16dB min.	30MHz-45MHz
	-14dB min.	45MHz-60MHz
	-12dB min.	60MHz-80MHz
Cross Talk	-38dB min.	300kHz-100MHz
Diff. To Common Mode Rejection	-38dB min.	300kHz-100MHz

Note1: See specification sheet for actual electrical characteristics

Features

- Meets IEEE 802.3 standards
- Dual port configuration
- Surface mount
- Transfer mold package
- Optional pin-outs
- Industry standard connector footprint
- Optimum performance
- Cost Effective
- Both RoHS compliant and lead-terminal parts available

Part Number	Transmit Turns Ratio	AutoMDIX Compatible	Operating Temp. Range	Schematic
000-6120-37 <sup>2</sup>	1CT:1CT	No	0°C to +70°C	1
000-6181-37 <sup>3</sup>	1CT:1CT	No	-40°C to +85°C	2
000-6241-37	1CT:1CT	No	-40°C to +85°C	2
000-6254-37	1CT:2CT	No	0°C to +70°C	3
000-6265-37	1CT:1CT	No	0°C to +70°C	4
000-6789-37	1CT:1.414CT	No	0°C to +70°C	5
000-6812-37	1CT:1.25CT	No	0°C to +70°C	6
000-7086-37	1.4CT:1CT	No	0°C to +70°C	7
000-7362-37	1CT:1CT	No	-40°C to +85°C	6

Note2: Missing terminals 5 and 11 for keying purposes.

Note3: Missing terminals 4 and 13 for keying purposes.

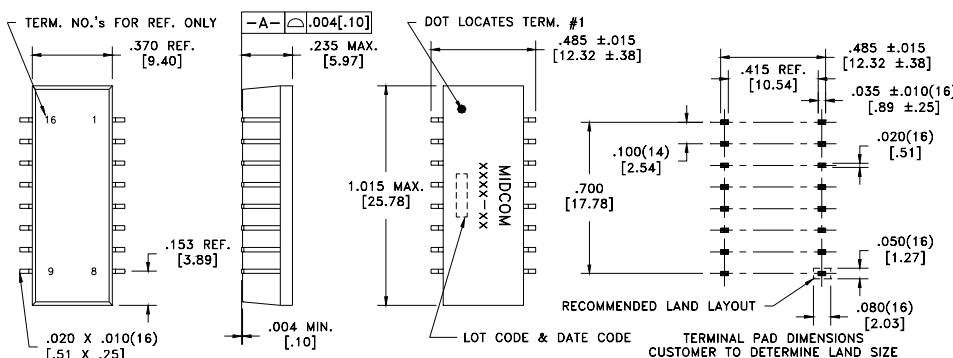

# Discrete Single Port 10/100 Base-T PDFP-G16 Schematics

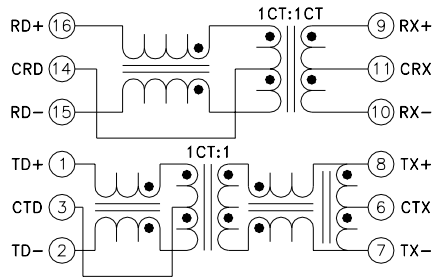

Schematic 1

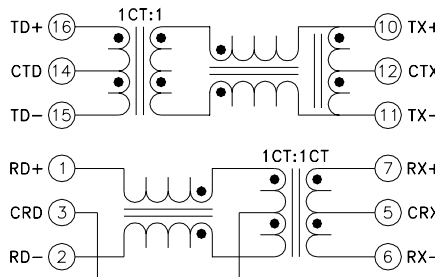

Schematic 2

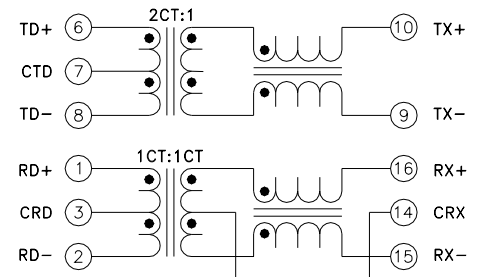

Schematic 3

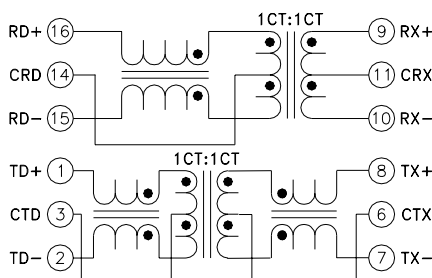

Schematic 4

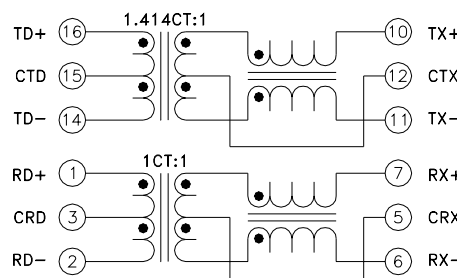

Schematic 5

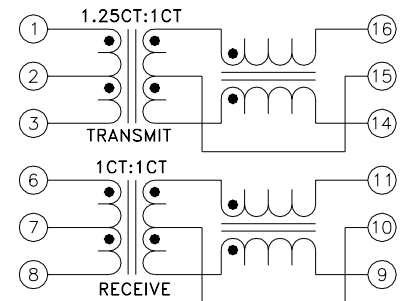

Schematic 6

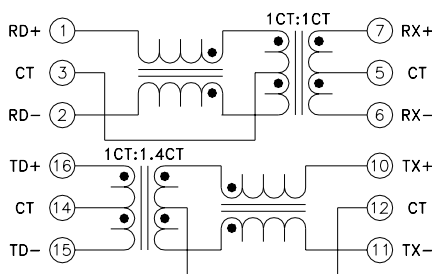

Schematic 7