

Material:
 Housing: 30% Glass filled PPS UL94V-0
 Contacts: Phosphor Bronze or Brass
 Plating: Gold 1.25u" over 50u" nickel

Electrical Characteristics:
 Current Rating: 3.0 AMP
 Insulator Resistance: 1000M Ω min. at DC 100V
 Contact Resistance: 10m Ω max.
 Operating Temperature: -40°C ~ +105°C

Order Information:
 L-KLS1-209-1.9-1-XX-S-Y

L: RoHS
 IC Socket
 Plastic height:
 1.9mm, 3.0mm, 4.2mm, 7.0mm
 Row: 1-Single layer
 2-Double layer
 XX-No. of 02 ~ 80pin
 Type: S-Straight Pin
 R-Right Angle Pin T-SMT Pin
 Y-Imported material pin
 Z-Domestic material pin

GENERAL TOLERANCE	PROJECTION		Description:
X. ± 0.50	UNITS	mm	2.54mm Pitch SIP Socket Connector
.X ± 0.25	SCALE	1:1	
.XX ± 0.10	Draw by:	Jenny	KLS P/N: L-KLS1-209-1.9-1-XX-S-Y
ANGLE TOLERANCE	Check by:		NingBo KLS ELECTRONIC CO.,L TD.
X. $\pm 5^\circ$	Date	2018-03-01	
.X $\pm 3^\circ$	SHEET	1 OF 1	
.XX $\pm 2^\circ$			

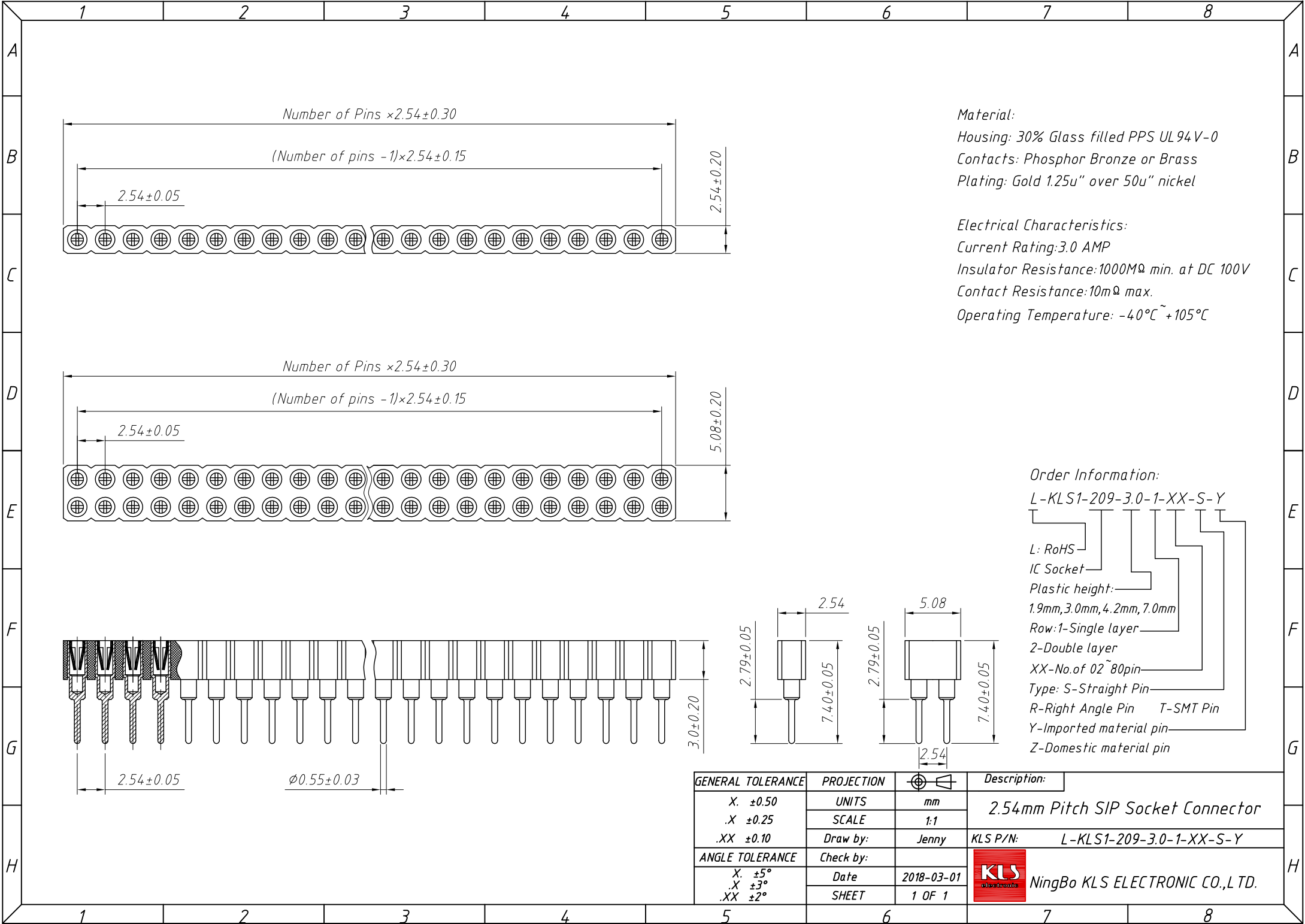

Material:
 Housing: 30% Glass filled PPS UL94V-0
 Contacts: Phosphor Bronze or Brass
 Plating: Gold 1.25u" over 50u" nickel

Electrical Characteristics:
 Current Rating: 3.0 AMP
 Insulator Resistance: 1000MΩ min. at DC 100V
 Contact Resistance: 10mΩ max.
 Operating Temperature: -40°C ~ +105°C

Order Information:
 L-KLS1-209-3.0-1-XX-S-Y

L: RoHS
 IC Socket
 Plastic height:
 1.9mm, 3.0mm, 4.2mm, 7.0mm
 Row: 1-Single layer
 2-Double layer
 XX-No. of 02 ~ 80pin
 Type: S-Straight Pin
 R-Right Angle Pin T-SMT Pin
 Y-Imported material pin
 Z-Domestic material pin

GENERAL TOLERANCE	PROJECTION		Description:
X. ±0.50	UNITS	mm	2.54mm Pitch SIP Socket Connector
.X ±0.25	SCALE	1:1	
.XX ±0.10	Draw by:	Jenny	KLS P/N: L-KLS1-209-3.0-1-XX-S-Y
ANGLE TOLERANCE	Check by:		NingBo KLS ELECTRONIC CO.,L TD.
X. ±5°	Date	2018-03-01	
.X ±3°	SHEET	1 OF 1	
.XX ±2°			

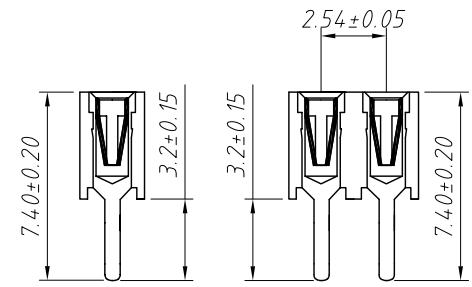
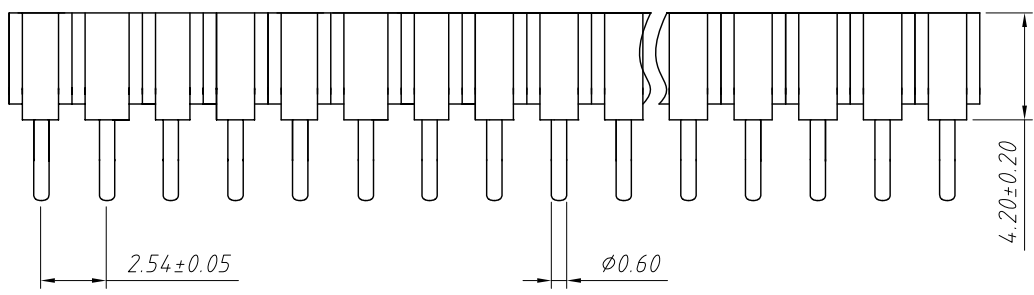
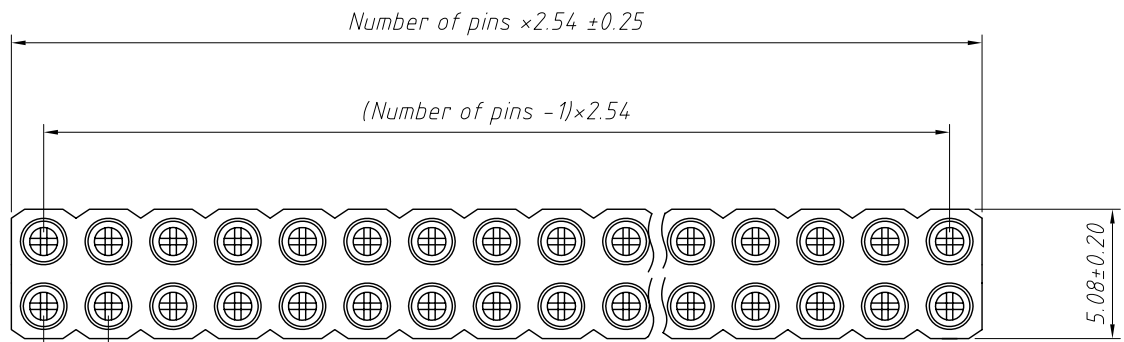
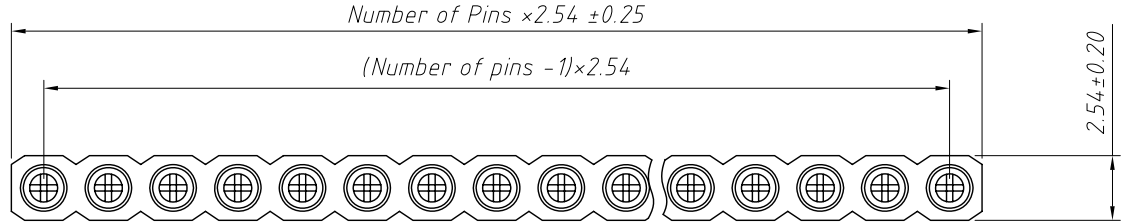

Material:
 Housing: 30% Glass filled PPS UL94V-0
 Contacts: Phosphor Bronze or Brass
 Plating: Gold 1.25u" over 50u" nickel

Electrical Characteristics:
 Current Rating: 3.0 AMP
 Insulator Resistance: 1000MΩ min. at DC 100V
 Contact Resistance: 10mΩ max.
 Operating Temperature: -40°C ~ +105°C

Order Information:
 L-KLS1-209-4.2-1-XX-S-Y
 L: RoHS
 IC Socket
 Plastic height:
 1.9mm, 3.0mm, 4.2mm, 7.0mm
 Row: 1-Single layer
 2-Double layer
 XX-No. of 02 ~ 80pin
 Type: S-Straight Pin
 R-Right Angle Pin T-SMT Pin
 Y-Imported material pin
 Z-Domestic material pin

GENERAL TOLERANCE	PROJECTION		Description:
X. ±0.50	UNITS	mm	2.54mm Pitch SIP Socket Connector
.X ±0.25	SCALE	1:1	
.XX ±0.10	Draw by:	Jenny	
ANGLE TOLERANCE	Check by:		KLS P/N: L-KLS1-209-4.2-1-XX-S-Y
X. ±5°	Date	2018-03-01	NingBo KLS ELECTRONIC CO.,L TD.
.X ±3°	SHEET	1 OF 1	
.XX ±2°			

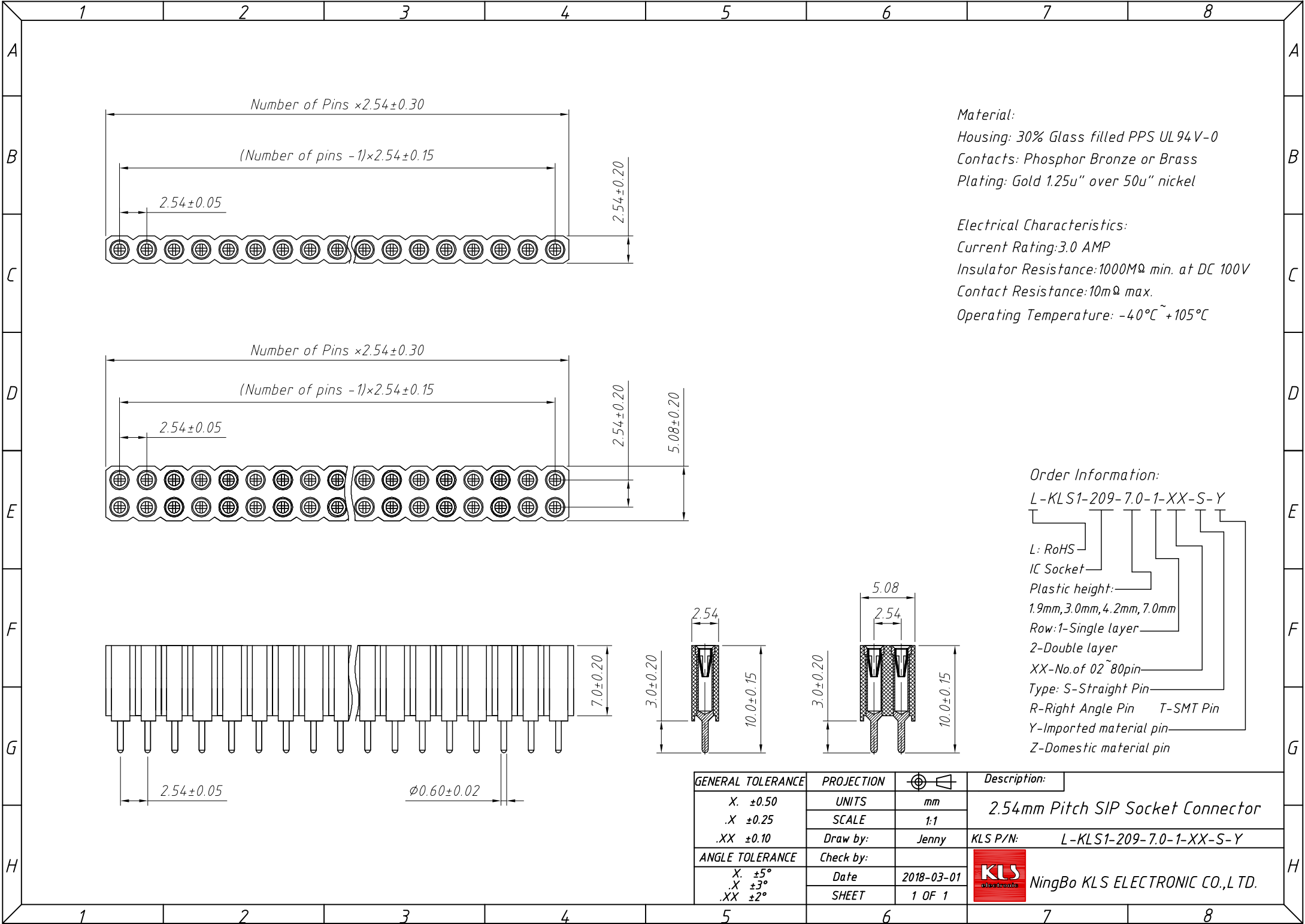

Material:
 Housing: 30% Glass filled PPS UL94V-0
 Contacts: Phosphor Bronze or Brass
 Plating: Gold 1.25u" over 50u" nickel

Electrical Characteristics:
 Current Rating: 3.0 AMP
 Insulator Resistance: 1000MΩ min. at DC 100V
 Contact Resistance: 10mΩ max.
 Operating Temperature: -40°C ~ +105°C

Order Information:
 L-KLS1-209-7.0-1-XX-S-Y

L: RoHS
 IC Socket
 Plastic height:
 1.9mm, 3.0mm, 4.2mm, 7.0mm
 Row: 1-Single layer
 2-Double layer
 XX-No. of 02 ~ 80pin
 Type: S-Straight Pin
 R-Right Angle Pin T-SMT Pin
 Y-Imported material pin
 Z-Domestic material pin

GENERAL TOLERANCE	PROJECTION		Description:
X. ±0.50	UNITS	mm	2.54mm Pitch SIP Socket Connector
.X ±0.25	SCALE	1:1	
.XX ±0.10	Draw by:	Jenny	KLS P/N: L-KLS1-209-7.0-1-XX-S-Y
ANGLE TOLERANCE	Check by:		NingBo KLS ELECTRONIC CO.,L TD.
X. ±5°	Date	2018-03-01	
.X ±3°	SHEET	1 OF 1	
.XX ±2°			

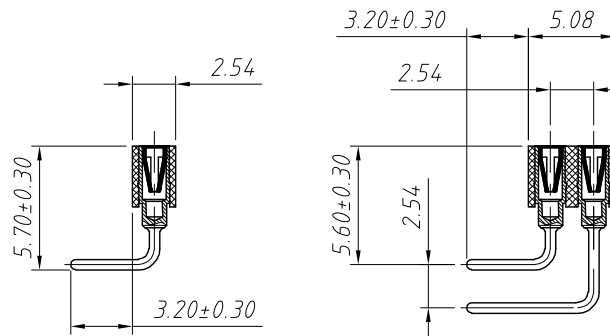
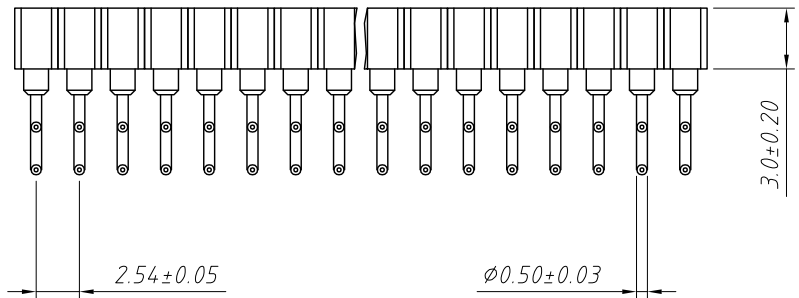
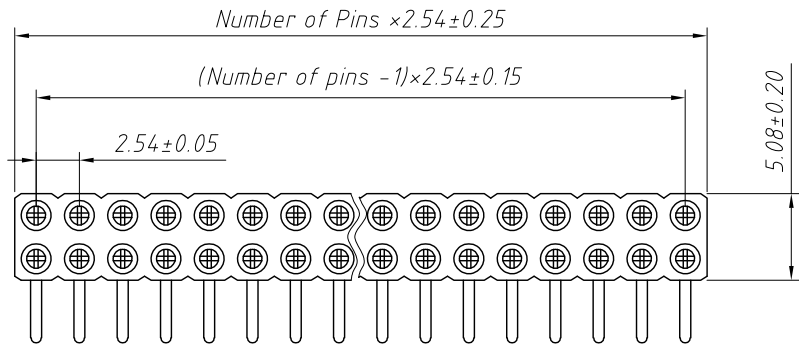
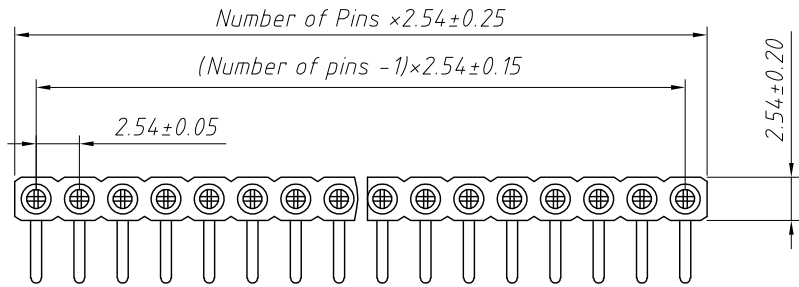

Material:

Housing: 30% Glass filled PPS UL 94V-0

Contacts: Phosphor Bronze or Brass

Plating: Gold 1.25u" over 50u" nickel

Electrical Characteristics:

Current Rating: 3.0 AMP

Insulator Resistance: 1000M Ω min. at DC 100V

Contact Resistance: 10m Ω max.

Operating Temperature: -40°C ~ +105°C

Order Information:

L-KLS1-209-3.0-1-XX-R-Y

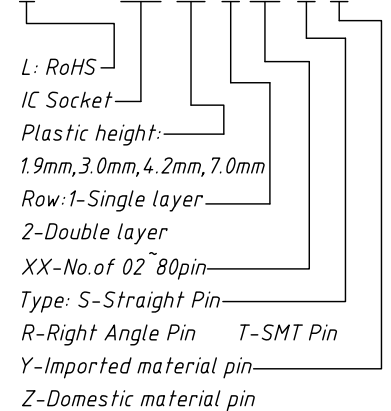

GENERAL TOLERANCE	PROJECTION		Description:
X. ± 0.50	UNITS	mm	2.54mm Pitch SIP Socket Connector
.X ± 0.25	SCALE	1:1	
.XX ± 0.10	Draw by:	Jenny	KLS P/N: L-KLS1-209-3.0-1-XX-R-Y
ANGLE TOLERANCE	Check by:		NingBo KLS ELECTRONIC CO.,L TD.
X. $\pm 5^\circ$	Date	2018-03-01	
.X $\pm 3^\circ$	SHEET	1 OF 1	
.XX $\pm 2^\circ$			

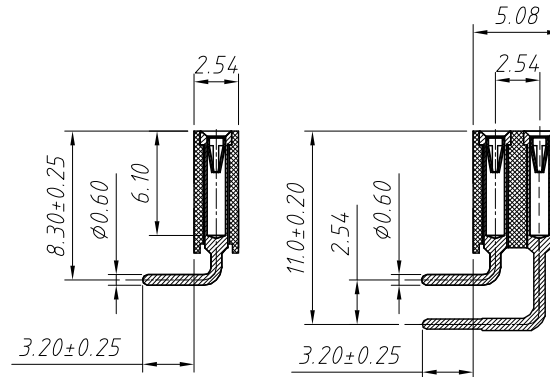
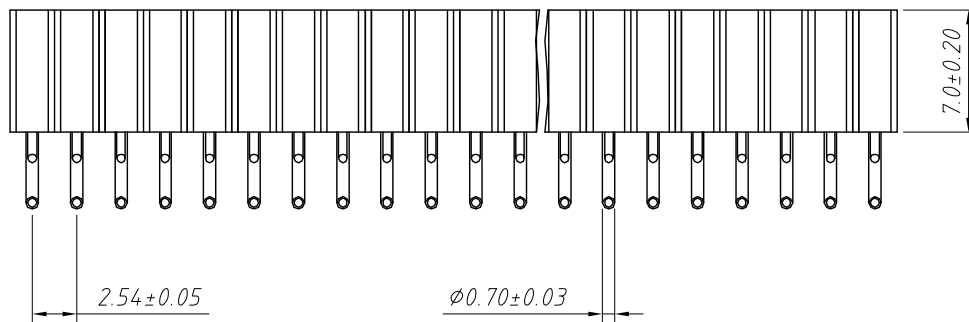
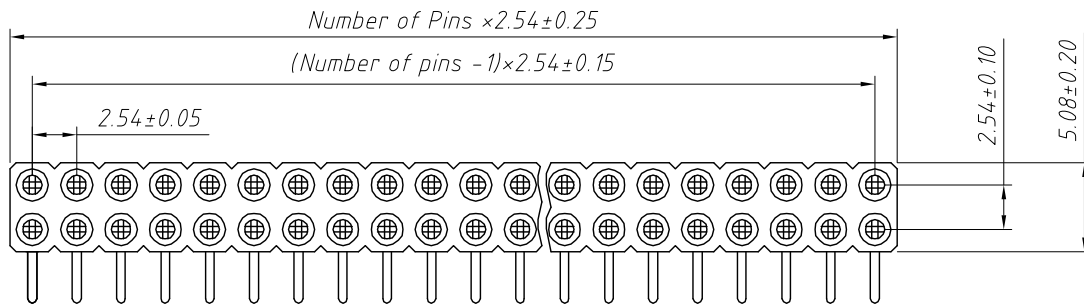
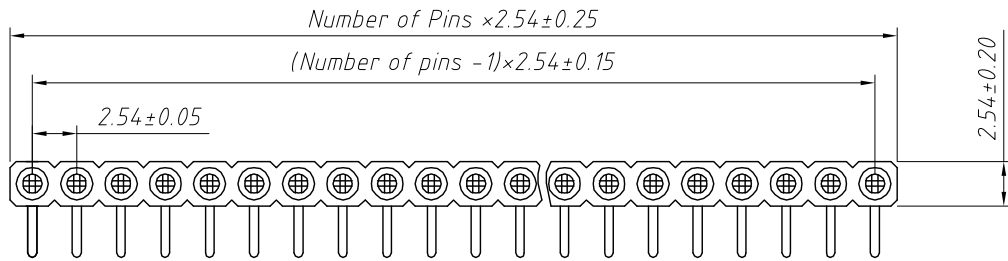

Material:
 Housing: 30% Glass filled PPS UL 94V-0
 Contacts: Phosphor Bronze or Brass
 Plating: Gold 1.25u" over 50u" nickel

Electrical Characteristics:
 Current Rating: 3.0 AMP
 Insulator Resistance: 1000MΩ min. at DC 100V
 Contact Resistance: 10mΩ max.
 Operating Temperature: -40°C ~ +105°C

Order Information:

L-KLS1-209-7.0-1-XX-R-Y

- L: RoHS
- IC Socket
- Plastic height: 1.9mm, 3.0mm, 4.2mm, 7.0mm
- Row: 1-Single layer
- 2-Double layer
- XX-No. of 02 ~ 80pin
- Type: S-Straight Pin
- R-Right Angle Pin
- T-SMT Pin
- Y-Imported material pin
- Z-Domestic material pin

GENERAL TOLERANCE	PROJECTION		Description:
X. ±0.50	UNITS	mm	2.54mm Pitch SIP Socket Connector
.X ±0.25	SCALE	1:1	
.XX ±0.10	Draw by:	Jenny	
ANGLE TOLERANCE	Check by:		KLS P/N: L-KLS1-209-7.0-1-XX-R-Y
X. ±5°	Date	2018-03-01	NingBo KLS ELECTRONIC CO.,L TD.
.X ±3°	SHEET	1 OF 1	
.XX ±2°			

1 2 3 4 5 6 7 8

A

B

C

D

E

F

G

H

A

B

C

D

E

F

G

H

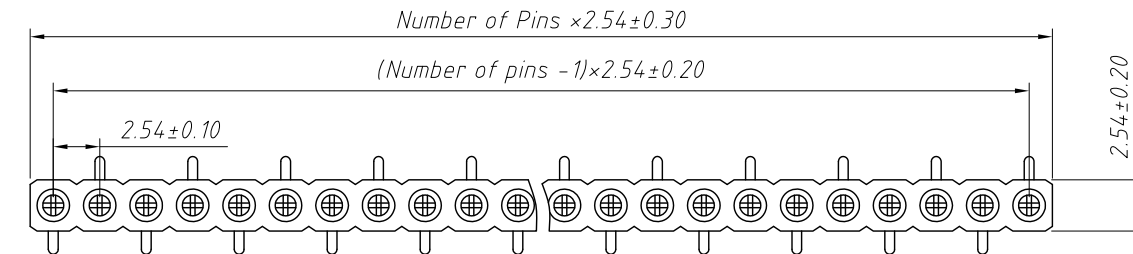

T2 Type

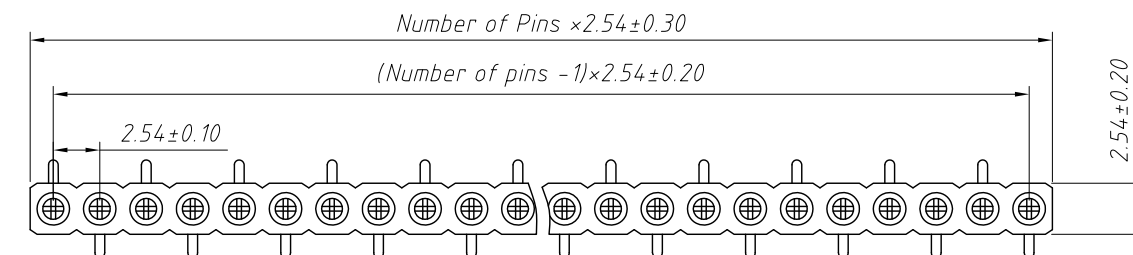

T1 Type

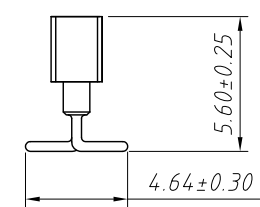
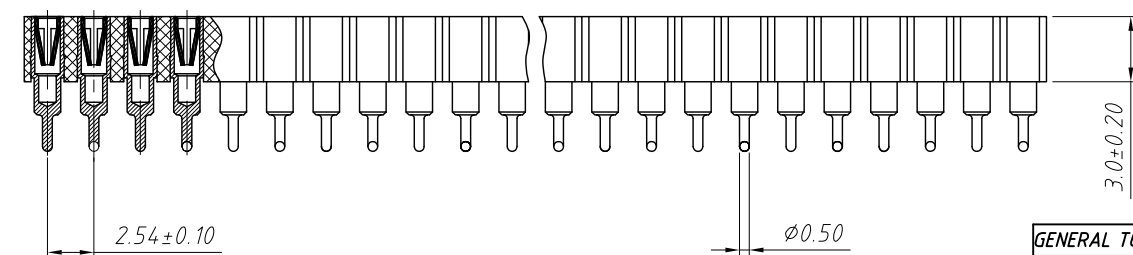

Material:
 Housing: 30% Glass filled PPS UL94V-0
 Contacts: Phosphor Bronze or Brass
 Plating: Gold 1.25u" over 50u" nickel

Electrical Characteristics:
 Current Rating: 3.0 AMP
 Insulator Resistance: 1000MΩ min. at DC 100V
 Contact Resistance: 10mΩ max.
 Operating Temperature: -40°C ~ +105°C

Order Information:
 L-KLS1-209-3.0-1-XX-T1-Y

- L: RoHS
- IC Socket
- Plastic height: 1.9mm, 3.0mm, 4.2mm, 7.0mm
- Row: 1-Single layer
- 2-Double layer
- XX-No. of 02 ~ 80pin
- SMT Type: T1 Type, T2 Type
- Y-Imported material pin
- Z-Domestic material pin

GENERAL TOLERANCE	PROJECTION		Description:
X. ±0.50	UNITS	mm	2.54mm Pitch SIP Socket Connector
.X ±0.25	SCALE	1:1	
.XX ±0.10	Draw by:	Jenny	KLS P/N: L-KLS1-209-3.0-1-XX-T1-Y
ANGLE TOLERANCE	Check by:		NingBo KLS ELECTRONIC CO.,L TD.
X. ±5°	Date	2018-03-01	
.X ±3°	SHEET	1 OF 1	
.XX ±2°			

1 2 3 4 5 6 7 8

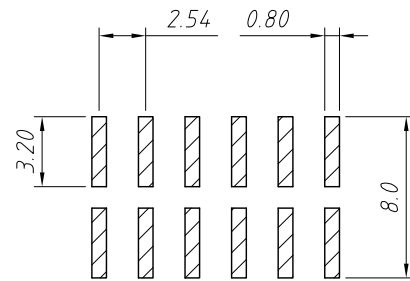
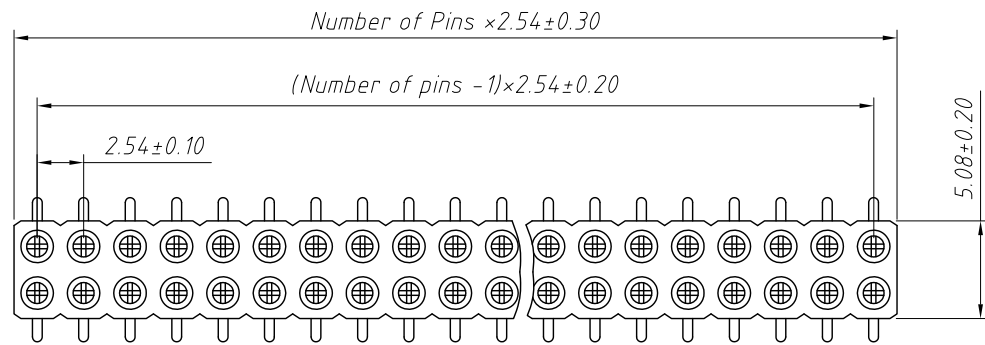

Recommended P.C.B Layout (Top Side)
 (PCB BOARD TOLERANCE ± 0.05)

Material:

Housing: 30% Glass filled PPS UL 94V-0

Contacts: Phosphor Bronze or Brass

Plating: Gold 1.25u" over 50u" nickel

Electrical Characteristics:

Current Rating: 3.0 AMP

Insulator Resistance: 1000M Ω min. at DC 100V

Contact Resistance: 10m Ω max.

Operating Temperature: $-40^{\circ}\text{C} \sim +105^{\circ}\text{C}$

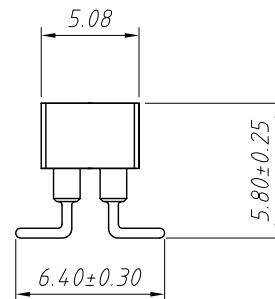
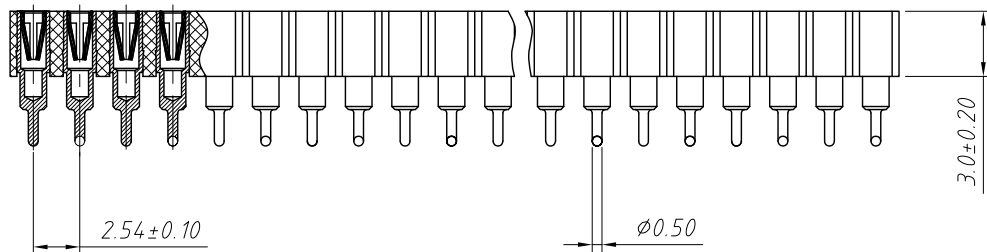

Order Information:

L-KLS1-209-3.0-1-XX-T-Y

L: RoHS

IC Socket

Plastic height:

1.9mm, 3.0mm, 4.2mm, 7.0mm

Row: 1-Single layer

2-Double layer

XX-No. of 02 ~ 80pin

Type: S-Straight Pin

R-Right Angle Pin T-SMT Pin

Y-Imported material pin

Z-Domestic material pin

GENERAL TOLERANCE	PROJECTION		Description:
X. ± 0.50	UNITS	mm	2.54mm Pitch SIP Socket Connector
.X ± 0.25	SCALE	1:1	
.XX ± 0.10	Draw by:	Jenny	
ANGLE TOLERANCE	Check by:		KLS P/N: L-KLS1-209-3.0-1-XX-T-Y
X. $\pm 5^{\circ}$	Date	2018-03-01	NingBo KLS ELECTRONIC CO.,L TD.
.X $\pm 3^{\circ}$	SHEET	1 OF 1	
.XX $\pm 2^{\circ}$			